

# MODERN WIRELESS



December.

1/-

Vol. 2. No. 3.

Edited by JOHN SCOTT-TAGGART, F.Inst.P., Member I.R.E.

December, 1923.



Vol. II.

# No. 3

**CHOOSING A WIRELESS CHRISTMAS PRESENT.**

**THE ST 150, A NEW RECEIVING CIRCUIT.** *By John Scott-Taggart, F.Inst.P.*

**HOW TO MAKE A CABINET TWO-VALVE MAGNIFIER,** *By Percy W. Harris.*

**AN EXPERIMENTAL CRYSTAL SET ON NEW LINES.** *By E. H. Chapman, D.Sc.*

**WHAT TO DO WITH THREE VALVES.** *By John Scott-Taggart, F.Inst.P.*

**LOUD SPEAKERS AND HOW THEY WORK.** *By E. Alexander.*

**NEW AMERICAN SINGLE-VALVE CIRCUITS.** *By A. D. Cowper, M.Sc.*

**More Long-Wave Circuits.** *By G. P. Kendall, B.Sc.* **Switches in Wireless Circuits.** *By O. J. Rankin.*

NUMEROUS PRACTICAL HINTS AND TIPS.

FREE WITH THIS ISSUE—"JUNIOR WIRELESS," A MAGAZINE FOR BOYS.



# A LINE OF *Western Electric* LOUD SPEAKERS



No. 44002.

No. 44005.

No. 44004.

No. 44003.

*A complete line of our Loud Speakers is now available, all of which have been most carefully designed and constructed in consideration of the needs of the public.*

No. 44003.—A small Loud Speaker operating on an ordinary magnetic diaphragm principle. The trumpet is of a non-metallic material with adequate acoustical properties. This model gives sufficient volume to enable a small audience to hear well in a quiet room.

No. 44004.—A Loud Speaker of medium size operating on the standard receiver principle but having a large diaphragm and an adjustable air-gap which enables the utmost efficiency to be obtained upon any particular current strength. This Loud Speaker gives most excellent reproduction.

No. 44005.—This model is of medium size and operates on the balanced armature principle as so successfully applied in the case of the now famous Loud Speaking equipment. More powerful than the No. 44004 model, this Loud Speaker gives adequate volume without distortion.

No. 44002.—The now familiar Loud Speaker, known universally as part of the Western Electric Loud Speaking Equipment. Operating on the balanced armature principle this powerful model gives most faithful reproduction and purity of tone and is free from distortion

**MADE BY THE MAKERS OF OVER HALF THE WORLD'S TELEPHONES.**

***Western Electric Company Limited.***

**CONNAUGHT HOUSE, ALDWYCH, LONDON, W.C.2.**

Telephone: Central 7345 (9 lines).

Leeds, Manchester, Newcastle, Cardiff, Birmingham, Southampton, Glasgow, Dublin. Also Singapore, Johannesburg, Buenos Ayres, Sydney, etc., etc.

# What do you think of this

AERIAL

## THERE'S NO QUESTION ABOUT IT

—IT'S POSITIVELY THE CUTEST INVENTION SINCE THE ADVENT OF WIRELESS!

Imagine—a pair of headphones just attached to earth and aerial, without any separate Receiving Set or loose trailing wires—and perfect results!

Our illustrations clearly depict the appearance of this remarkable invention, which is just like a pair of standard headphones practically normal in size and certainly normal in appearance except for the adjuster-switch for tuning to the required wave-length. Each set forms a complete unit for each individual, and there is no diminution of volume by the addition of other sets of 'phones.

**The novelty of it! The convenience of it!  
The marvel of it! The economy of it!  
... and THE PRICE OF IT!!**

*Permanent detector—no "cat's-whiskers" to worry with: simply put the headphones on and move the switch to the requisite Broadcasting wave-length. British manufacture throughout; approved P.M.G.; 4,000 ohm 'phones.*

The whole outfit is cheaper than the usual run of Headphones alone, but we guarantee, without qualification or reservation, that the results you will obtain will be as consistently efficient as it is possible to get on any ordinary crystal set within 25 miles of any B.B.C. Station.

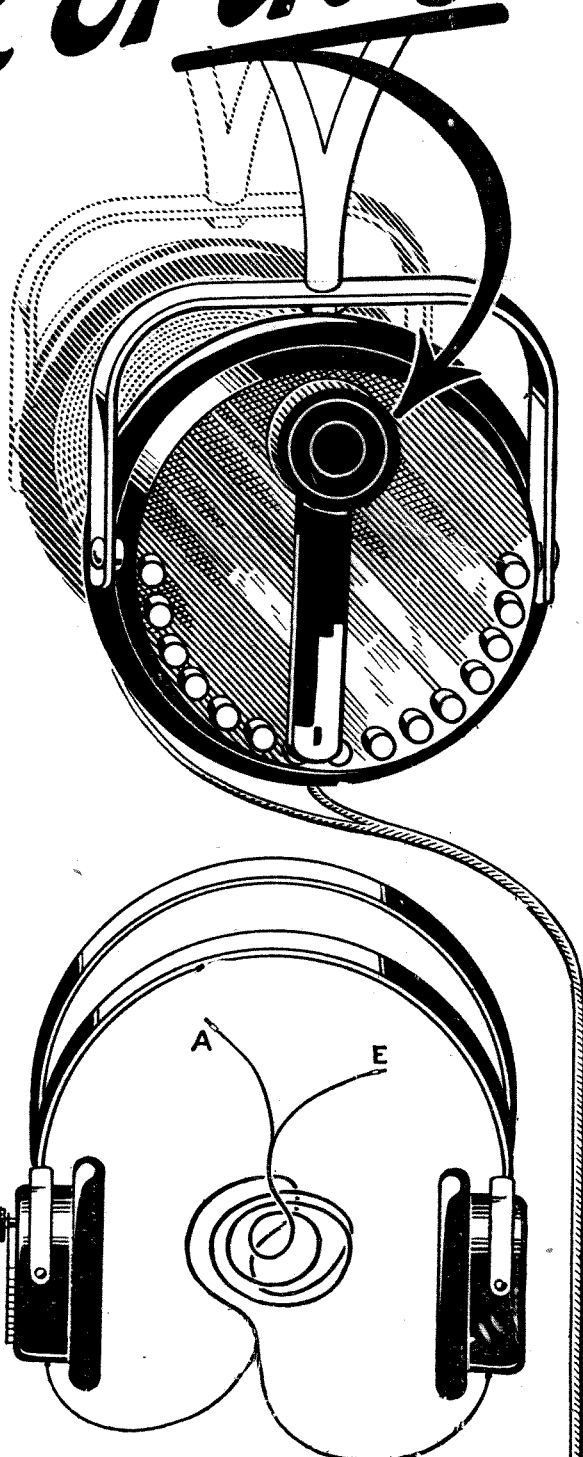

POST FREE **25/-** COMPLETE  
With Aerial-Earth Insulators.

GEORGE MANUFACTURING CO.  
WIRELESS SPECIALISTS  
Nelson Chambers, High Street, Birmingham

EARTH

Limited territories still open for Trade representation.



# RADIOBRIX

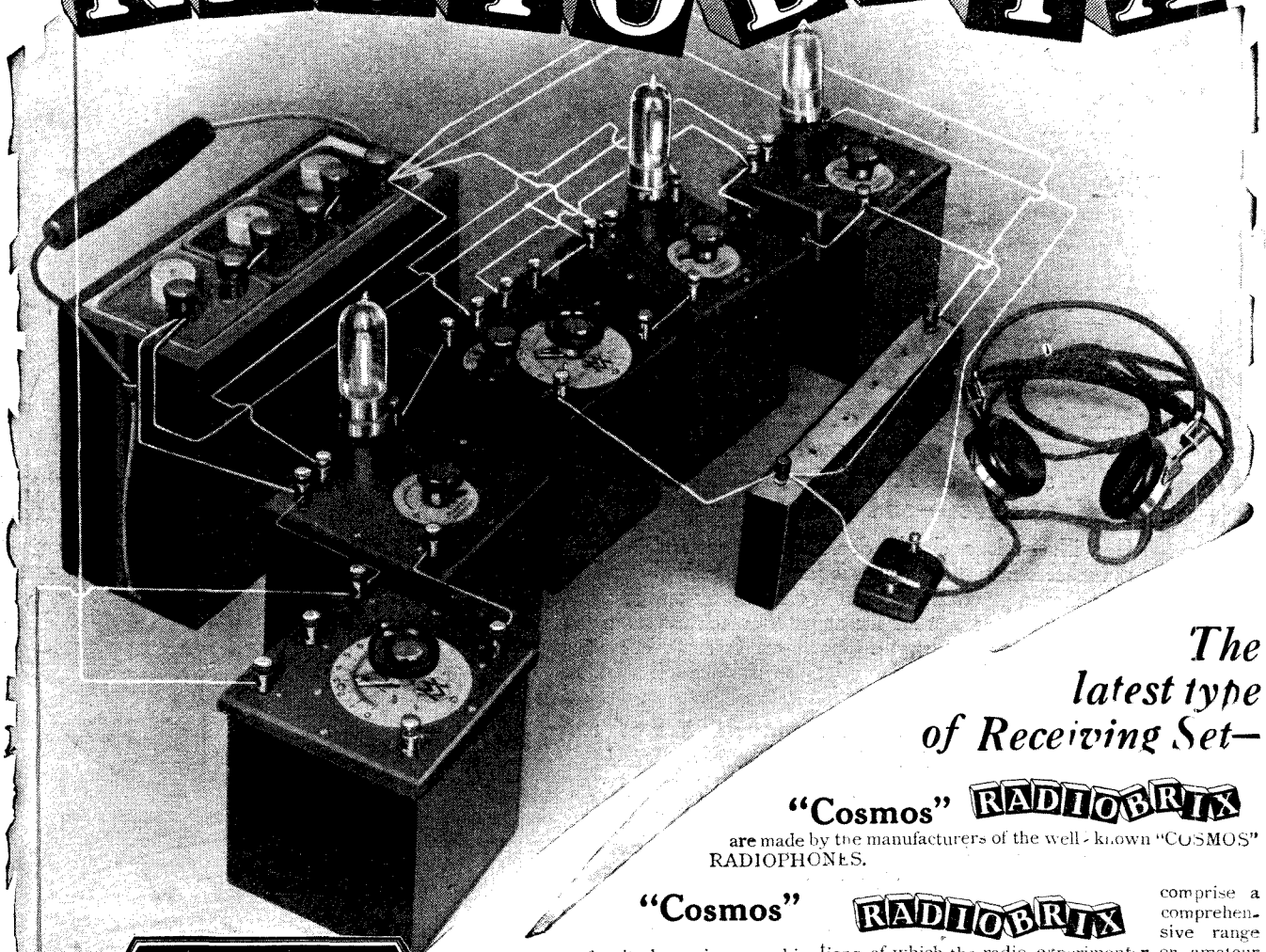

The latest type of Receiving Set—

“Cosmos” **RADIOBRIX** are made by the manufacturers of the well-known “COSMOS” RADIOPHONES.

“Cosmos” **RADIOBRIX** comprise a comprehensive range of units by various combinations of which the radio experimenter or amateur can build up any type of receiving set or circuit.

“Cosmos” **RADIOBRIX** have been designed to secure the utmost flexibility. They enable the “listener” to build up his set gradually as his means allow, yet the bricks obtained at first never become useless, but can be utilized as part of a more elaborate set.

“Cosmos” **RADIOBRIX** are thoroughly well made and moderate in price.

Ask your regular Wireless dealer to show you

“Cosmos” **RADIOBRIX** If he has not yet obtained his stock, write, sending his name to the manufacturers:—

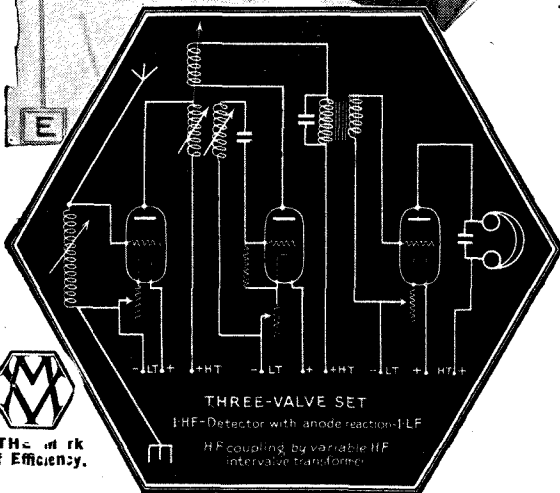

**THE MARK of Efficiency.**

The above illustration and diagram shows a three-valve set made up with RADIOBRIX. Get a copy of the new book “BUILDING WITH RADIOBRIX,” full of useful circuits with theoretical and wiring diagrams, obtainable everywhere, 1/-, or post free, 1/5.

**METROPOLITAN Vickers**  
 ELECTRICAL CO. LTD

TRAFFORD PARK, MANCHESTER.

R X02

BUILD YOUR RADIO SET WITH R.A.D.I.O.B.R.I.X.





## What is NEW and what is GOOD in the WIRELESS WORLD ?

HERE at the Service Co. Store there is a Wireless Department in which you can see, select or merely chat about all that is new and good in Wireless. Comfortable—pleasantly—you can get an expert manager who will "understand" and advise as to your ideas and needs.

To understand the Lowest Prices compatible with first-class instruments—the Help which is offered to buy what you want, on Easy Payments, if desired—and the pleasant spirit of Service which makes our Store a friendly place. Call in if you can, or write as to any wish or requirement.

Write for Catalogue 'E' to-day if you cannot call.



Wireless Department

292-3, HIGH HOLBORN, LONDON, W.C.1

R.H.

With this



to guide you

the building of either Crystal or Valve sets is extremely simple.

The "B.B.L." Booklet of Wiring Diagrams shows all the Components required in their relative positions for wiring up. Get a copy from your Dealer. . . . . PRICE 1/-

TRADE ONLY SUPPLIED KINDLY ORDER FROM YOUR USUAL DEALER.

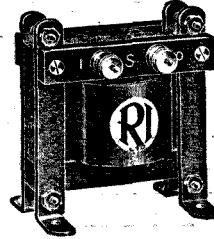

INTERVALVE AUDIO-FREQUENCY TRANSFORMER. (Radio Instruments Ltd.) Ratio 4 to 1. This Transformer has a closed magnetic circuit similar to a Power Transformer and is constructed on the same lines. Will not burn out when high voltages are used on the anode. List No. 17190.

PRICE 25/-

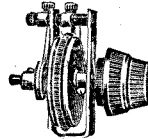

WOODHALL VARIOMETER (Moulded Ebonite)

Filament Rheostats (Granite) Vernier type for detector circuits. Plain type for amplifying circuits. List No. 16834 with Vernier adjustment . . . . . 7/- List No. 16831 without Vernier Adjustment . . . . . 4/6

Wave-lengths with P.M.G. aerial, 251/750 metres. Very close coupling. Internal winding firmly fixed by special process, eliminating dead-end effect and capacity losses. List No. 15342 less dial and knob. PRICE 15/9

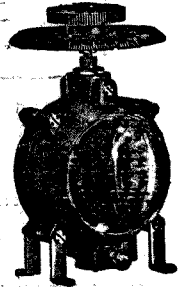

### Brown Brothers

with which is amalgamated Thomson & Brown Brothers, Ltd.

Wholesale only. Head Offices and Warehouses: Great Eastern Street, London, E.C.2. 118, George Street, Edinburgh, & Branches.

## Wherever you live

you can listen-in to the nearest Broadcasting Station with the new "St. Vincent" Crystal-Valve Efescaphone Set, illustrated here. It is designed to give maximum signal strength over the whole range of broadcasting wave lengths. The modest price of this new Efescaphone model brings the pleasure of listening-in within the reach of most people.

### A loud speaker with one valve

The one-valve "St. Vincent" Set will work a loud speaker within a radius of from 10 to 15 miles from a Broadcasting Station, while the two-valve set will do so within a radius of from 30 to 40 miles. The difference between the one and two-valve models is the relative strength of signals.

For those who live within 15 miles of a Broadcasting Station the "Benbow" Crystal Set is ideal. It costs complete only £3 10s., plus 1s. B.B.C. tariff

Send a post card for detailed catalogue of these and many other models of



Receiving Sets, and name of nearest dealer.

From all Wireless Dealers, Stores, and Electricians.

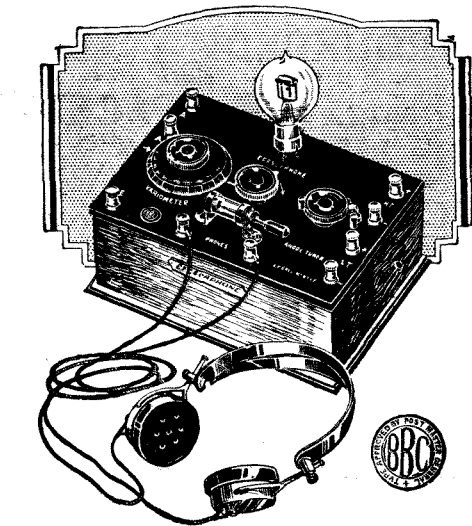

Listen-in with an Efescaphone

The "ST. VINCENT" Model

Price complete, except valves :

Crystal-one-valve, £11

Plus 6/- extra for B.B.C. tariff.

Crystal-two-valve, £15

Plus 11/- extra for B.B.C. tariff.

Wholesale only : FALK, STADELMANN & CO., Ltd., Eiesca Electrical Works, 83, 85, 87, Farringdon Road, London, E. C. 1. And at Glasgow, Manchester & Birmingham.

All Wave-Lengths  
Covered.

P.P. No. 2250/23.

COME WHAT  
COME MAY  
THE "ATLAS" COILS

Once Tried

NOW LEAD THE WAY

Always Used.

MAXIMUM  
INDUCTANCE

OPTIMUM  
WAVE-LENGTH  
RANGE



MINIMUM  
SELF-CAPACITY

INCREASED  
SIGNAL  
STRENGTH

Radio Components Catalogue on Request.

Trade Terms on Application.

**SALIENT FEATURES are :**

The TWIN-WIRE WINDING is so effected as to enable MORE THAN 95 p.c. of each strand to be SURROUNDED BY AIR. EACH TURN and EACH LAYER being AIR-SPACED REDUCES CAPACITY TO UTMOST LIMIT.

WOUND IN TRUE CONCENTRIC CIRCLES, the Coils give FINE TUNING, so ESSENTIAL TO CUTTING OUT UNWANTED SIGNALS.

Agency applications considered for districts where not already represented.

**"ATLAS" PATENT PLUG-IN COILS**

Coil No.	Wave-length in metres with .001 Variable Condenser in shunt.		Price s. d.
	Min.	Max.	
25	120	375	5 0
35	175	515	5 0
40	180	650	5 2
50	230	780	5 2
65	280	1000	5 6
75	325	1120	5 6
100	410	1520	7 0
150	660	2300	7 10
200	850	3100	8 8

Manufactured only by—  
**H. CLARKE & Co.**

(MANCHESTER), LTD.,  
Radio Engineers,  
Atlas Works, Old Trafford,  
:: MANCHESTER. ::

Tel. Nos.: 683 & 793      Telegrams:  
Trafford Park.      Pirtoid, Manchester.

Coil No.	Wave-length in metres with .001 Variable Condenser in shunt.		Price s. d.
	Min.	Max.	
250	1280	4150	9 0
300	1550	4940	9 5
400	2045	6380	10 3
500	2980	8900	10 6
600	4000	12100	11 0
750	4970	15000	11 10
1000	6100	20000	12 8
1250	7000	22000	14 0
1500	8200	26000	15 0



# HULLO EVERYBODY!!

## CALLERS' COLUMN

Buy Best Goods at Low Prices.

Terminals (complete with Nuts).	
Large W.O. . . . . 4 for 5d., doz.	1/3
W.O. Pillar . . . . . 1 for 5d., doz.	1/3
Small Pillar . . . . . 1d. each, doz.	9d.
Switch Arm, 12 Studs and Nuts, the lot	1/-
Small Variometers, 250/650, with knob and bush	2/4
Larger Variometers, 250/650 . . . . .	2/8
Igranic Variometer, Ebonite, 350/650 . . . . .	15/-
2-Way Coil Holders, for Duolateral Coils	5/6, 4/6
3-Way Coil Holders, for Duolateral Coils	6/11, 5/11
Phillips R Type . . . . .	7/-
Stop Pins, with shoulder . . . . . 2 a 1d. doz.	5d.
Fixed Condensers '001 10d., up to '005 . . . . .	1/3
Fixed Condensers '006 up to '01 . . . . .	1/6
Valve Pins . . . . . doz. 6d. Sockets . . . . . doz.	9d.
2, 4, 5 B.A. Nuts . . . . . 3 doz.	6d.
Basket Coils . . . . . Set of 6	2/-
Spade Terminals . . . . . doz.	4d.
Vario Couplers, with Knob, Wound, D.C.C.	4/11
Glass Enclosed Whisker Detector . . . . .	1/8
High-Class Whisker Detector (large), enclosed . . . . .	2/6
Fine Perikon, 2 Crystals, enclosed . . . . .	3/-
Small Perikon, 2 Crystals . . . . .	2/-
Bel Wire, D.C.C., I.C. 2 og. . . . . 10 yds.	2/6
Twin Flex . . . . . 12 yds. 1/7, 4 yds.	7d.
Plug Coils, Ebonite . . . . . 1/-	1/3
Extra Quality, ditto on base . . . . .	1/-
Pillar Terminals, Nut and Washer, 2 B.A., large . . . . .	6d.
Switch Arms . . . . . 8d., 9d., 10d.	2/3
Filament Resistances . . . . . 1/8 1/10, 2/-	4/6
Igranic Resistances . . . . .	7/6
Igranic Vernier . . . . .	4d.
4 Cat's-Whiskers, one gold . . . . .	1/4
Single Basket Coil Holders . . . . .	1/5
Variable Grid Leaks . . . . .	3/-
Bretwood Variable Grid Leaks, guaranteed 3 years . . . . .	3d.
Pin Terminals, screw pattern, 1/3 doz., 2 for	3d.
Spade Terminals, screw pattern, 1/3 doz., 2 for	1/-
Shaw's Genuine Hertzite . . . . . 9d.	2/-
Grid Leaks and Condensers, .0003, 3/-, 2/3,	1/-
Valvet Sockets, with shoulder and nuts . . . . .	2/-
Basket Coils, Duplex Waxless, set of 5 for 100,000 ohm Resistance . . . . .	1/6
Variometer on Ebonite, ball rotor, wound, D.C.C. . . . .	7/9
Accumulator, 6 v. 50 amp., in handsome wood case, strap handle . . . . .	27/6
D.C.C. Wound Tapped Coils . . . . . 2/-, 1/9,	1/6
Double Phone Cords . . . . . pair	9d.
Wound Coils 12 x 4, best quality . . . . .	2/6
Wound Coils, 6 x 3, best quality . . . . .	1/9
D.P.S.T. Switches, special . . . . .	1/3
S.P.D.T. on Ebonite . . . . . 1/3 to	2/9
D.P.D.T. on Ebonite . . . . . 1/11 to	2/9
2 B.A. Rod, 12 in. . . . . 3d. foot, 2 for	5d.
Basket Coil Holders, for 3 coils . . . . .	5/6
Plug and Socket, brass . . . . . pair	1d.
Fixed Condensers, .01 . . . . .	1/6
Pocket Lamp Batteries (best) . . . . . 6 for	2/3
Special Filament Resistance, very fine value	2/-
D.P.D.T. Nickel Switches for panel mounting	2/6
FIL. RES. DIALS, 0-10 . . . . .	7d.
4 v 40 B. Accumulator, callers only . . . . .	16/6
Splendid Loud Speaker, complete with trumpet	36/-
Real Ebonite Slider Knob and Plunger . . . . .	6d.
Set of Names (12), engraved black or white	6d.
Insulated Hooks . . . . . each	1d.
Copper Foil . . . . . per foot	4d.
Best Zincite and Bornite . . . . . pair	1/-
Ebonite Turned Valve Holder . . . . .	1/-
Shellac . . . . . bottle	5d.
Timed Copper, 16, 18, 20 g. . . . .	2/6
Formo Fil. Resistance, best . . . . .	6/8
Dutch Val. res. vertical . . . . .	6/11
Dutch Valves, horizontal . . . . .	15/-
Xtraudion V Ives (E.E.C.) . . . . .	15/-

## RAYMOND

### VARIABLE CONDENSERS

BRITISH MAKE.

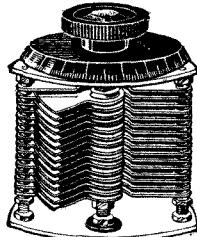

Without Dial.	'001 . . . . . 6/6	'001 . . . . . 7/6
'00075 . . . . .	5/6	'00075 . . . . . 6/9
'0005 . . . . .	4/9	'0005 . . . . . 5/9
'0003 . . . . .	4/2	'0003 . . . . . 5/2
'0002 . . . . .	3/-	
'0001 . . . . .	2/8	

Dial not supplied with above.

Above is special offer. Dial not supplied separate.

Reg. Post and Packing 6d. set. Colonial post 2/- set.

### HEADPHONES.

4000 ohms "Sidpe" genuine . . . . .	Per Pair	14/9
8000 " . . . . .	16/-	
4000 " Brunet . . . . .	17/6	
4000 " N. & K. . . . .	14/9	
4000 " Light weight . . . . .	11/11	
Receiver for Loud Speaker, with Cord . . . . .	18/11	
Premier B.B.C 4,000 ohms, very fine value . . . . .	16/11	

Post 1/- pair.

**ERICSSON "EV" TYPE PHONES**  
4000 ohms. Thousands sold last season.  
Lovely tone. 13/9 per pair. Post 1/- pair

**1,000 VALVES (NEW)**  
NOT BANKRUPT STOCK, but purchased from a firm going out of business.

**EDISWAN DULL EMITTER** . . . . . 25/9  
**EDISWAN, COSSOR, MARCONI R** . . . . . 12/6  
**MULLARD "ORA"** . . . . . 12/6  
WHILE THEY LAST, NO POST.

**L.F. Intervalve Transformers.**  
5-1 Radio Instruments, Ltd. (1) . . . . . 25/-  
5-1 Ingranic shrouded (2) . . . . . 21/-  
5-1 Formo shrouded 18/- (3) . . . . . 15/-  
5-1 Raymond . . . . . 12/6  
On Transformers (1), (2) and (3) goods to the value of 1d. in the 1/- given free to callers.

### H. T. Batteries

60 v. . . . .	10/6 & 12/6
36 v. . . . .	5/- & 5/6

**THE SIMPLEX BROADCAST CRYSTAL SET**  
The most efficient, simple and inexpensive crystal set made, range, 200-600 metres. Will receive all broadcasting stations within a radius of 40 miles, using telephones of average sensitivity with a standard P.M.G. aerial. Very fine tuning obtainable using basket coils of very low self-capacity. Every set sold has been tested, and is guaranteed SIMPLE, CHEAP and EFFICIENT. 12/6 Per Set. Post, 1/-.  
ALL PREVIOUS LISTS CANCELLED.

## POST ORDER COLUMN

NO POST ORDERS except for goods in this column, and at prices marked, which include all post, rail and packing charges, U.K. only.

ALL ORDERS EXECUTED IN STRICT ROTATION.

Accumulators, high-class goods, 4 v. amps . . . . .	20/-
Fixed Condensers, .003 to .001 . . . . .	1/4
Fixed Condensers, .002 to .005 . . . . .	1/8
Fixed Condensers, .006 . . . . .	2/-
Ebonite Valve Holders, 8 nuts, each 1/6, 3 for	4/-
Ebonite Dials and Knob, turned ebonite . . . . .	2/- 2/6
D.P.D.T. Switches, small size, on ebonite base	3/3
S.P.D.T. Switches, small size, on ebonite base	2/9
Variable Grid Leak (Bretwood), guar. 3 years . . . . .	3/6
Variable Grid Leak, usual pattern . . . . .	2/6
Two-Way Coil Holders, 3 qualities, all good value . . . . .	5/6, 6/6, 7/6
Three-Way ditto, as above . . . . .	6/9, 7/6, 8/9
Twin Flex for Extension Leads . . . . . 12 yds.	2/3
Grid Leak and Condenser, .0002, .0003, .0005	2/9
Grid Leak, 2 megohms . . . . .	1/4
Pin Terminals, screw pattern, for phone leads . . . . . 6 for	1/-
Spade Terminals, screw pattern, for phone leads . . . . . 6 for	1/-
Ebonite Coil Plugs, high-class article, each 1/3, 6 for	6/9
4 Cats-whiskers (gold, silver, etc.) . . . . .	6d.
Bell Wire, D.C.C., I.R.C. . . . . 10 yds.	1/-
100,000 ohms Resistance . . . . .	2/-
Switch Arms, very good quality, complete with 12 studs . . . . .	2/-
Valve Sockets, polished, with shoulder and nuts . . . . . doz. 1/6 3 doz.	4/-
Shaw's Genuine Hertzite Crystal . . . . .	1/6
Double Phone Cords, with screw terminals . . . . .	1/6
Basket Coil Holders, for 3 coils, on stand . . . . .	6/-
Basket Coil Holders, single, with coil plug	2/9
Filament Resistances (not cheap rubbish) 2/6, 2/8, 3/9	2/9
Very Special ditto (limited number) . . . . .	2/9
Terminals, Telephone, with nut, doz. 1/9, 6 doz.	8/-
Terminals, Large W.O. pattern, with nut . . . . . doz. 1/9 6 doz.	8/-
Terminals, Large Pillar, with nut, doz. 1/9 6 doz.	8/-
Terminals, Extra Large 2 B.A., with nut . . . . . 6 for 2/6, doz.	4/6
Variometers and knob, 250/650 . . . . .	4/6
Basket Coils up to 3,500 metres . . . . . set of 6	2/6
Spring Washers . . . . . 3 doz.	2/-
Crystal Detectors, all best quality, not Junk, Enclosed, large whisker . . . . .	3/3
Crystal Detectors, enclosed, smaller whisker	2/9
Crystal Detectors, enclosed, large, Perikon, 2 crystals . . . . .	3/9
Crystal Detectors, enclosed, slightly smaller ditto . . . . .	3/3
Many Other Detectors, open type 2/-, 2/6, 2/9, 3/-	3/-
L.F. Intervalve Transformers, Radio Instruments, Ltd. . . . .	25/-
L.F. Intervalve Transformers, Igranic (shrouded) . . . . .	21/-
L.F. Intervalve Transformers, Formo . . . . .	15/-
L.F. Intervalve Transformers, Raymond . . . . .	13/9
Variometer on Ebonite Ball Rotor . . . . .	10/-
Igranic Variometers, Inside Winding . . . . .	15/-
Sets of 12 Name Tabs, black or white . . . . .	1/-
2 B.A. Nuts . . . . . per gross	1/10
Real Ebonite Slider Knob and Plunger . . . . .	1/-
Insulating Sleeve, all colours . . . . . 6 yds.	2/9
Amplion Junior Loud Speaker . . . . .	52/6
Best Knobs, Bushed 2 B.A. . . . . 4 for	1/6
Brunet Phones, 4,000 ohms . . . . .	18/6
N. and K. Standard, 4,000 ohms . . . . .	15/9
N. and K. Lightweight, 4,000 ohms . . . . .	13/9
Receiver for Loud Speaker, with 50 laminations in each pole . . . . .	18/11
B.B.C. Best Phones, 4,000 ohms . . . . .	17/11
Amplion Junior Loud Speaker . . . . .	42/-

TRADE AND RADIO CLUBS SUPPLIED. I advertise what I sell, and sell what I advertise. HONEST GOODS AT THE RIGHT PRICE. Right Reserved to Return Cash.

RIGHT OPPOSITE  
**DALY'S**  
GALLERY DOOR

**K. RAYMOND**  
27, LISLE STREET, W.C.2

HOURS  
OF BUSINESS:  
DAILY - 9 to 7.45  
SUND, 10.30 to 1



# Contents

	Page
Editorial .....	119
A Useful Three-Valve Receiver .....	123
By M. G. FERGUSON.	
Catalogues Received .....	123
In Passing .....	124
Wireless and a Christmas Present.....	123
A Cabinet Two-Valve Magnifier .....	123
By PERCY W. HARRIS.	
What to Do with Three Valves .....	135
An Experimental Crystal Set .....	141
By E. H. CHAPMAN, D.Sc.	
Wireless in Switzerland .....	143
By H. E. ADSEAD.	
Above and Below the Broadcast Wavelength .....	144
Spiral Connections for Partially Rotating Shafts .....	147
A Guide for Shortening Screws .....	147
The ST-150 Circuit .....	143
By JOHN SCOTT-TAGGART, F.Inst.P.	
A Free Gift to Readers .....	151
Some More Long-Wave Circuits .....	152
By G. P. KENDALL, B.Sc.	
The Transatlantic Receiver : Modifications for Long Waves .....	155
By PERCY W. HARRIS.	
The Measurement of Wireless Quantities : Resistance... ..	157
By E. H. CHAPMAN, M.A., D.Sc.	
Loud-Speakers .....	160
By E. ALEXANDER.	
Some American Single-Valve Circuits .....	168
By A. D. COWPER, M.Sc.	
Switches in Wireless Circuits .....	169
By O. J. RANKIN.	
Two to Six Volts from the Same Accumulator .....	173
By R. W. HALLOWS, M.A.	
Silencing Noisy Amplifiers .....	175
By A. PAGE.	
The Care and Maintenance of Wireless Apparatus .....	177
By R. L. ROPER.	
"Tested by Ourselves" .....	180
JUNIOR WIRELESS.	

*Editor :*  
JOHN SCOTT-TAGGART,  
F.Inst.P.

*Joint Assistant Editors :*  
PERCY W. HARRIS,  
E. REDPATH.

*Staff Editors :*  
E. H. CHAPMAN,  
M.A., D.Sc.  
A. D. COWPER, M.Sc.  
G. P. KENDALL, B.Sc.  
R. W. HALLOWS, M.A.  
S. G. RATTEE.

*Scientific Adviser :*  
Prof. G. W. O. HOWE,  
D.Sc., M.I.E.E.

*Advisory Editors :*  
Prof. R. WHIDDINGTON,  
M.A., D.Sc.  
Prof. C. L. FORTESCUE,  
M.A., M.I.E.E.

*Advertisement Managers :*  
SCHEFF PUBLICITY  
ORGANISATION, LTD.,  
1-5, Pall Mall, London  
S.W.1.

*Tel.—Regent 2440.*

# MODERN WIRELESS

**Radio Press Ltd**

PUBLISHERS OF WIRELESS WEEKLY

DEVEREUX COURT.

• STRAND, W.C.2 •

Tel.—Central 5113.

All correspondence relating to contributions is to be addressed to the Editor of "Modern Wireless."

Nothing contained herein is to be regarded as permission or encouragement to infringe any patent rights.





**N**OW that the second All-British Wireless Exhibition is over and we have seen all the latest designs of apparatus, we may well consider the lines upon which British wireless appears to be developing. Perhaps the most pleasing fact is the practically complete disappearance of the "get-rich-quick" wireless manufacturer with his hysterical claims and ridiculous statements. The British people has never taken kindly to such sensation-mongers, whatever their success may have been in America, and now that the sensational element has gone, the public is settling down to choosing gear with the same discrimination that it applies to the purchase of, say, a camera. This is as it should be.

Yet, although commonsense statements are taking the place of exaggerated claims, we still found at the Show displays of elaborate furniture into which wireless sets, of more or less pretentious design, had been built. The manufacture of such sets seems to us pure waste of time and money, and furthermore has the effect of suggesting that a good wireless set is bound to be an expensive thing. The more enlightened public can, of course, differentiate between the £20 wireless set and the £80 cabinet, but there are a good number who are under the impression that if a set of this kind costs £100, a simple £20 set must be much inferior.

But in the main, as we have indicated, there is a tendency to simplify designs and give all-round efficiency in commonsense cabinets. A well-designed set should not need any disguise,

and if placed in a simple polished cabinet should not break the harmony of any furnishing scheme. Incidentally the trade should remember that the great majority of wireless sets will be purchased by people who have neither the money nor the inclination to indulge in period furnishing. The few whose artistic perceptibilities are jarred by the appearance of an ordinary set will probably have their own cabinet work made specially.

The new valves having a current consumption of scarcely more than that of bright emitters will undoubtedly revolutionise wireless sets. The old type of dull emitter, notwithstanding claims to the contrary, was not really a dry cell proposition, and if such cells are used with them the maintenance costs are abnormally high. The new valves, however, will work quite well on the ordinary dry cell which one purchases for the electric bell supply, and as these are very inexpensive the accumulator manufacturers may well feel perturbed. Crystal sets still remain popular and are likely to do so, for they have many advantages, of which the complete absence of trouble with accumulators and valves is not the least. In our opinion there is need for a good deal of research with regard to crystals, and we are not aware that a great deal is being done. The present "hit and miss" method of adjusting crystals is not satisfactory, and until we find or make some substance which is really equally sensitive all over the surface (in spite of claims now made for some crystals, not one possesses this property), we shall not obtain really fool-proof sets.

# A USEFUL THREE-VALVE RECEIVER

By M. G. FERGUSON.

*This receiver is a good example of the simplicity of wiring which makes for high efficiency; it is also economical to build.*

I SUPPOSE that a number of amateurs may still be up against the problem how to combine efficiency with economy? I would suggest that the problem ceases to exist if the experimenter makes his first aim and object simplicity the link between the first two.

The relationship of simplicity and economy is too obvious to need discussion; that of simplicity and efficiency is not so obvious, but it is as truly a matter of fact. It was with this aim that the set about to be described was designed, and in the design there is a complete absence of switches, the terminals and components being arranged to give the minimum of wiring, well spaced.

I do not mean to state that it is not possible to obtain efficiency in multi-valve sets with switching arrangements for each valve; but I do venture to say that it is very much easier to attain a high degree of efficiency by cutting out the switches, at any rate on the high-frequency side. Again, absence of switches spells economy.

ECONOMY.—The set as shown in the photographs will cost anything from £4 to £5 to make, according to the taste of the experimenter. This price, of course, does not include valves, batteries, phones, inductances, or a two-coil holder, all of which will be necessary before the set will function.

EFFICIENCY.—I think that a few excerpts from the log taken with the instrument the day after it was completed will be the best witness to this. (N.B.—My wireless den is at the top of a house in Hampstead, 4½ miles from 2 LO and 40 ft. from the ground. The aerial is a good one, but its height above the instrument is not more than 20 ft.

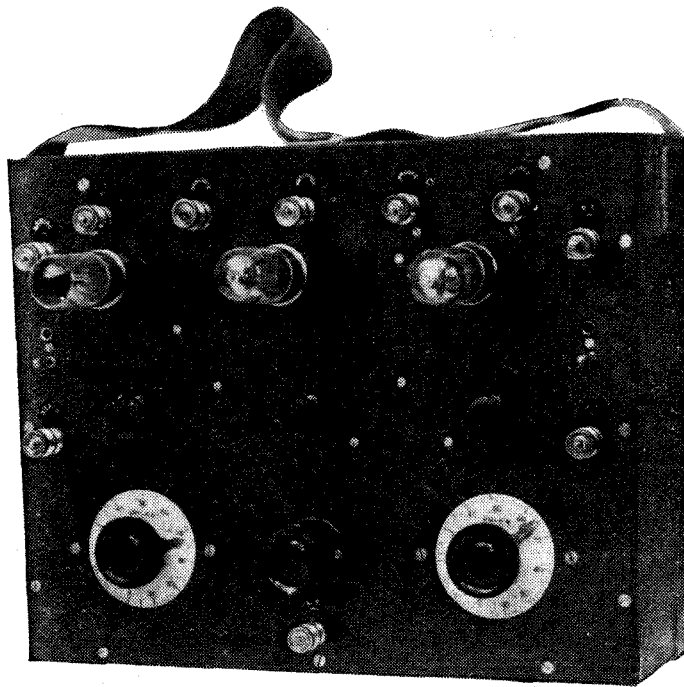

*This instrument is built to fit a teak cabinet, easily obtainable from "Disposals" dealers. Its neat appearance and symmetrical layout are pleasing.*

The earth is, of course, far from ideal, consisting of a wire 35 feet long connected to the water cistern at the top of the house.

In the log "L.S." in each case refers to three loud speakers connected in parallel and functioning in three different rooms in the house (for wave-trap B see recent numbers of MODERN WIRELESS or of *Wireless Weekly*).

Sunday, Nov. 4.  
8.12 p.m. Cardiff choir and Rev. J. Philip Rogers. Every word distinct in L.S., in spite of local amateur transmitters. 9.20 p.m., Glasgow wireless trio. Loud L.S. strength without wave-trap.

(Wave-trap B was now fitted, with Burndept S3 coil instead of a 50, and 2LO was completely cut out when desired.)

9.30 p.m. Mr. Frater will now sing "The Watchman," by Squire. Newcastle. L.S.

9.40 p.m. Birmingham. Part of Haydn's "Creation." L.S.

10.15 p.m. Bournemouth. Weather. L.S.

10.29 p.m. Ecole Superieure. French tenor singing, and then close down. L.S. As will be seen from the log, all the B.B.C. stations with the exception of Manchester and Aberdeen came in at loud-speaker strength; as a matter of fact, neither of these stations could be heard on the phones that night. Of course, conditions vary, and personally I should be very much surprised if I got the same results every

night; but I nearly always find 51T, 6BM and 5SC coming through at L.S. strength.

To the East, Moscow can be heard at L.S. strength; to the West, Annapolis and several other American stations; the time signals from Balboa, Panama, have been heard at 0955 (wave-length 7,000 metres), but only when Eiffel Tower on 7,300 and a more



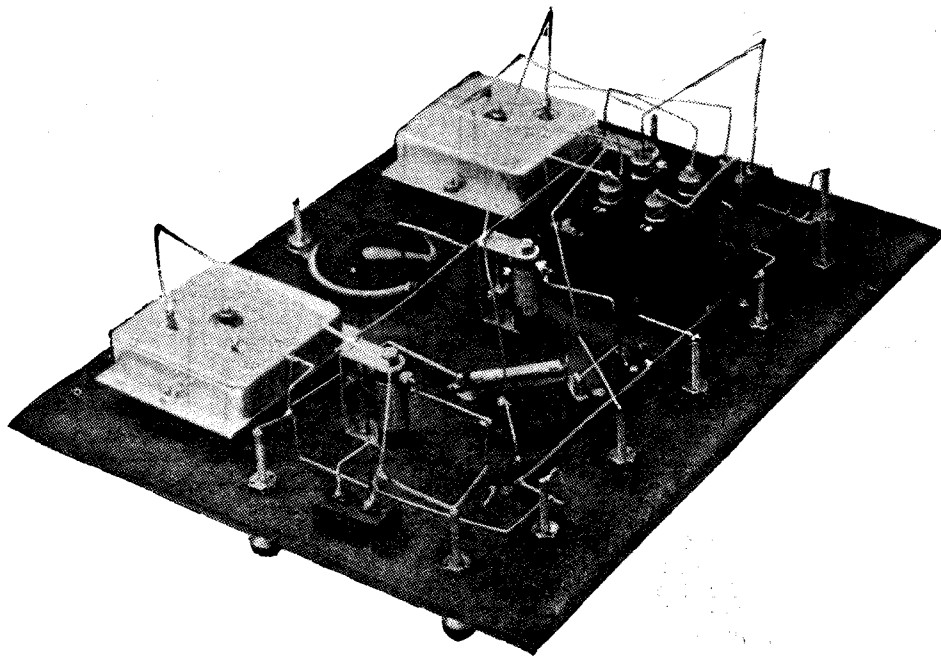

*The underside of panel. Notice the extreme simplicity of wiring.*

powerful station, whose identity at present is unknown, on about 7,200 metres, are both silent.

Now as to details of the instrument and construction. The teak cabinet with ebonite panel fitted was purchased for the sum of ten shillings only from Leslie Dixon and Co. The variable condensers in this set are Polar. There are now on the market cheaper variable condensers of the ordinary air-dielectric, moving-vane type, which are very efficient; there is no reason why these should not be fitted; as I said before, it is largely a matter of taste. The transformer is a Fuller, chiefly chosen for its compactness; any good transformer can be substituted for this. The fixed condensers are Dubilier, and the grid leak and condenser Mullard. With regard to this last, normally the clips for the grid leak are on the top of the condenser; in order to connect the grid leak to the L.T. + both of these clips were removed. One was then replaced, but in a reverse position; and the other mounted on the panel in such a way as to grip the grid leak firmly. The filament rheostats are made by T. C. Ball, and have been found to be very smooth in action; they also take up very little room on the panel. The terminals are the 4BA double pattern; name tabs

from the City Accumulator Co.; valve-holders, Burndept.

Perhaps somewhat unusual features about the set are firstly the extra Burndept 3-valve filament rheostat, and the Burndept coil-plugs mounted behind the panel on each side. The advantage of the first-named is this: when the

correct positions of the other three filament rheostats have been found they can be left alone, and the filament current can be completely turned off gradually by the extra rheostat. The gradual brightening and dimming of the filaments with the on and off movements will mean longer life to the valves. The use of the coil-plugs is for the rapid change-over of reaction from A.T.I. to tuned anode, and *vice versa*. The method is as follows:—

First, the reaction coil is always plugged into the moving coil-plug of the two-coil stand (a small D.P.D.T. switch fitted on to the stand for reversing the current in the reaction

coil will be found to be a time-saver, and is shown in the theoretical diagram). Secondly, the wires from the fixed coil-plug of the stand are connected to a third coil-plug. Then, if we want reaction on the A.T.I., we put this third coil-plug into the plug on the panel between the aerial and earth terminals, the aerial coil into

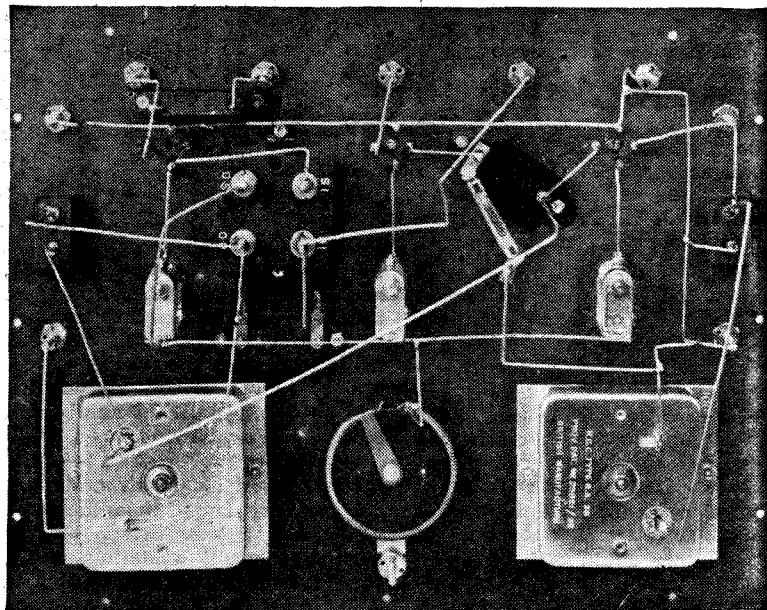

*A plan view of the wiring.*

the fixed coil on the stand, and the tuned anode coil into the plug on the panel between H.T. - and H. T. +. If we want reaction on the tuned anode, as for example on broadcasting wave-lengths, we put the third coil-plug into the plug on the panel between H.T. - and H.T. +, the tuned anode coil into the fixed plug of the stand, and the aerial coil into the plug between the aerial and earth terminals.

The following table of a few of the stations logged is given to serve as a rough guide as to proper choice of coils to use for given wave-lengths: the actual readings of the condensers will, of course, vary with the type of aerial condenser and make of inductance coil. The actual coils used were the original pattern Burnham coils, with the exception of the S coils, which are the more modern Burndept, and the 1,500 coils, which were respectively a Igranic and a home-made coil:—

Station.	Wave Length.	A.T.I.	Tuned Anode.	React.	A.T.C.	T.A.C.	Reaction.
Amateurs .. ..	200	S1	S2	S3	41	49	Tuned Anode.
Cardiff .. ..	353	S1	S3	S4	85	80	..
London .. ..	363	S2	S4	S4	0	18	..
Birmingham ..	385	S2	S4	S4	46	55	..
Ecole .. ..	450	S3	S4	S4	73	63	..
Ostend .. ..	600	S3	100	S4	75	51	Aerial Coil.
Croydon .. ..	900	75	150	100	48	0	..
Manchester .. ..	1300	100	200	150	58	64	..
Radiola .. ..	1780	100	200	150	98	98	..
Eiffel Tower ..	2600	200	400	300	65	27	..
Nauen .. ..	3100	200	400	300	77	64	..
Air Ministry ..	4100	400	500	300	26	34	..
Tours .. ..	5500	500	750	300	55	47	..
Eiffel Tower ..	7300	500	750	300	84	90	..
Nauen .. ..	9400	750	1000	300	68	57	..
Rome .. ..	11000	750	1000	300	77	66	..
Stavanger .. ..	12600	750	1000	300	88	90	..
Lyons .. ..	15500	1500	1500	400	79	72	..
Bordeaux .. ..	18940	1500	1500	400	98	98	..

As will be seen from this list the range of this instrument with standard coils runs from 150 metres to 19,000 metres; by connecting a small fixed condenser of 0.001  $\mu$ F. across the aerial and earth terminals and another of 0.0003  $\mu$ F. in shunt with the tuned anode coil the range can easily be extended up to Bordeaux top wave-length of 23,450 metres. The position of the condensers for Radiola are not too satisfactory; if it were found that Radiola could not be satisfactorily picked up with a one-higher coil in each of the second, third and fourth columns, with the condensers at zero it would be worth while winding a special

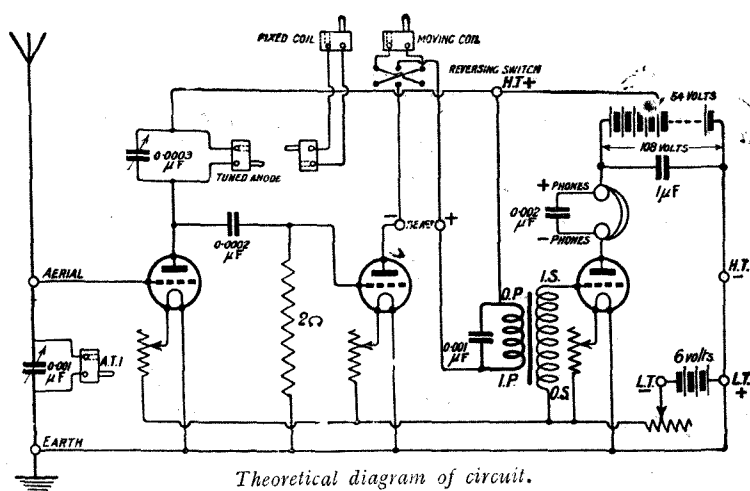

coil for the A.T.I. of 125 turns duolateral, and possibly a 225-turn coil for the tuned anode. The winding of these coils presents no difficulty even without any special winding machine; a coil of 600 turns wound by hand on a 2-in.

square section 16 or 18 S.W.G. wire. The dimensions given in the diagram may be followed if the same components are used. If not it is as well to mount the components on cardboard first to get the best arrangement. In any case it is better to do all your measuring and marking out on a sheet of cardboard cut to the size of the panel, and after this has been done to your satisfaction prick through the positions of the holes to be drilled on to the panel itself. When all the holes have been drilled, do not forget to remove from both sides of the ebonite the shiny surface with fine emery paper, rubbing preferably with a circular motion. When this has been done a fine polished matt surface may be obtained by a mixture of turpentine and emery powder, using plenty of elbow grease. The original shiny surface has a certain amount of tinfoil deposit on it, which, of course, must be removed.

Follows a detailed list of the cost of the components used:—

Cabinet and panel .. ..	£0 10 0
L.F. transformer .. ..	1 2 0
2 Polar condensers, 0.001 $\mu$ F. and 0.0003 $\mu$ F. ....	1 8 0
3 Filament rheostats (T.C.B.) ..	12 0
1 Filament rheostat (3-valve, Burndept) .. ..	5 0
2 Dubilier condensers, 0.002 and 0.001 $\mu$ F. .. ..	6 0
Mullard grid leak and condenser .. ..	5 0
Valve holders .. ..	3 0
2 special coil plugs .. ..	4 0
10 Terminals .. ..	2 6
10 Name tabs .. ..	2 6
	<hr/>
	£5 0 0

former with 22 pins on each side took only 2½ hours. If wound carefully, and a minimum of shellac is used, these coils will be found to compare very favourably with machine-made coils, and the saving of cost is very great. Details for winding will be found in recent numbers of MODERN WIRELESS.

CONSTRUCTION NOTES. — The tools required for constructing this set are very few; in addition to pliers and a screwdriver will be needed a small soldering outfit, small centre punch, hand drill with ⅜ in., 7/64 in., 5/32 in., 9/32 in., 3/16 in., ¼ in. twist drills, a rose bit, 11 6 B.A. ½ in. countersunk-head brass screws, and about 9 ft. of

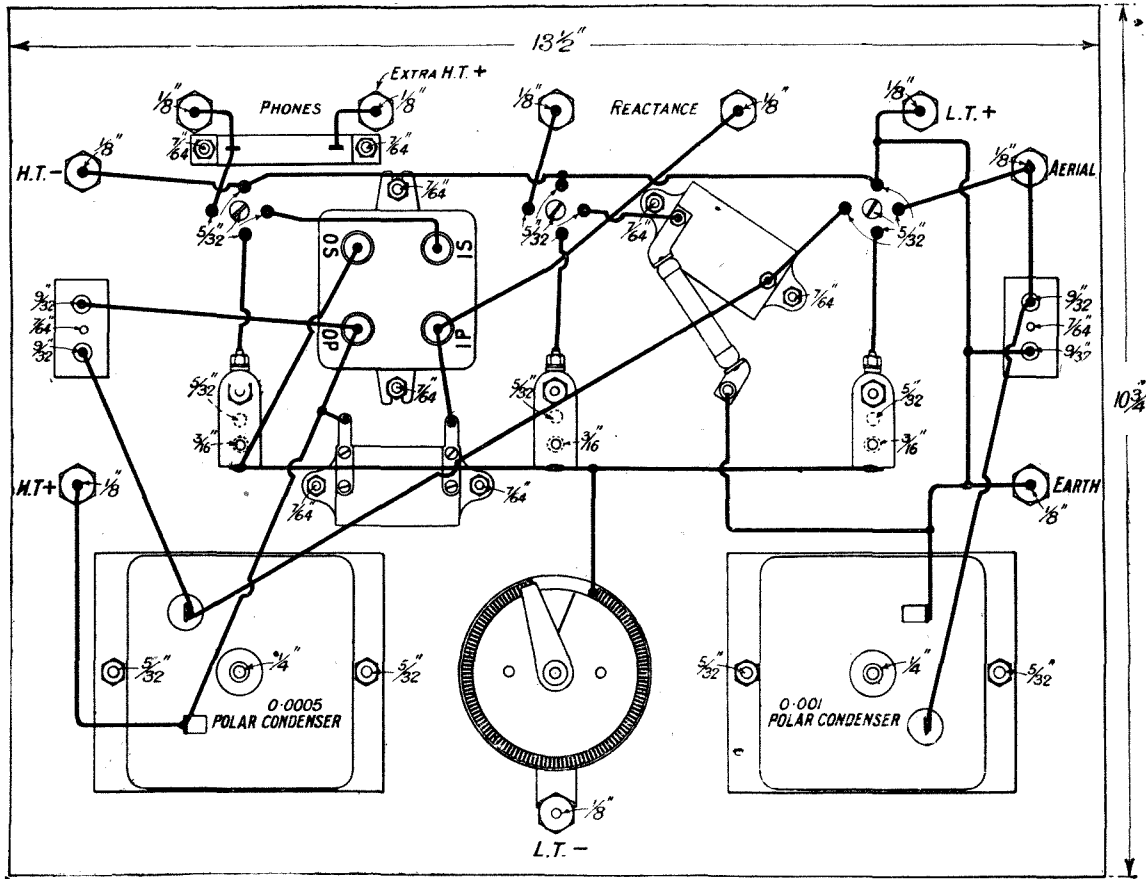

Detailed wiring diagram.

In addition to the above will be required, as already mentioned, valves, batteries, phones or loud speakers, inductance coils, an extra coil plug, a two-coil stand fitted with a small D.P.D.T. switch. A very efficient combination of valves for this instrument is a P2 Cossor for the H.F. (left-hand socket on front of panel), Ediswan A.R. for detector (middle socket, and any type of "R" valve for L.F. (right-hand socket), with about 54 volts on the first two valves, *i.e.*, across the H.T. terminals and 108 volts on the last valve, *i.e.*, across PHONES + (the middle, terminal on the top of the panel) and the H.T. -. Three Hellesen 36-volt cells were used, and if connected in series the - of cell No. 1 is connected to H.T. -, the 36 of cell No. 1 to - of cell No. 2, the 18 of cell No. 2 to H.T. +, the 36 of cell No. 2

to - of cell No. 3, and the 36 of cell No. 3 to PHONES +. A 1  $\mu$ F. condenser connected across the total H.T. will give smoother running as the battery gets older. The square section wire may be obtained from Messrs. Bowyer Lowe. In the set, as described, no provision is made for grid cells. With certain types of "R" valve an extra grid bias of 1 1/2 or 3 volts may mean further amplification. It would be worth while, before connecting permanently the O.S. of the transformer to the L.T. -, to try the effect of 1 1/2 v. or 3 v. between these points, connecting the + of your grid cell to the L.T. - connection, and then - to the O.S. of the transformer. With the components used it is very simple to connect wires temporarily to the O.S. terminal of the transformer and the screw on the frame of the L.F. rheostat.

## CATALOGUES RECEIVED

Just as we go to press we have received from the Igranic Electric Co. several highly interesting publications, including particulars of the new Igranic concert coils, Nos. 1, 2, 3 and 4, the complete set selling for £1. These coils differ from the usual honeycombs, having a more efficient form of mounting and, we would assume, a lower self-capacity. A second leaflet describes the new Igranic honeycomb high-frequency transformer wound by the honeycomb method and mounted on four pin base which has become so popular for high-frequency transformer mounting. There are six of these transformers, covering a range of wave-length up to 1,500 metres. We hope to test these and the coils just mentioned at an early opportunity. The Igranic Co. also send us a valuable booklet on the honeycomb coils.

DO NOT MISS THE BEGINNING OF THE NEW VOLUME OF "WIRELESS WEEKLY," 12 DEC.





**The Jolly Season.**

**C**HRISTMAS, we are informed upon the unquestioned authority of a bard of bygone days, comes but once a year. Those of us who have attained the rank and dignity of paterfamilias are perhaps thankful that it does not come more often, at any rate in our more gloomy moments when we brood over the plenteous crop of bills, demand notes and reminders that this or that little account is now very much overdue. The second line—I know not whether there be others—of this beautiful little poem strikes a happier note assuring us that when it comes it brings good cheer. The last word, by the way, does not mean jollity. In old English it signified quite simply food. Even in ancient days Christmas brought its little worries which men stifled with roast beef and plum porridge, or drowned in copious draughts of sack. In either case they were temporarily obliterated then, as they are now with more modern fare.

For the wireless man Christmas is a breathless time. His progeny, male and female, arrives home from its various seminaries of learning brimful of wireless lore acquired during term time, and madly desirous of bringing him up to date in the matter of new circuits.

**The Young Inquisitors.**

Hardly have they leapt from their taxis before wireless talk pours

from their young lips. They invade the radio den, examine one's gear and indicate pretty plainly that they are not impressed by their sire's progress during the time that they have been away. I always rather dread these first moments of the holidays, for one knows that one's whole reputation as a radioist is hanging in the balance.

Time was when one stood unquestioned as the supreme authority on all matters wireless, when the explanations that one gave in answer to questions as to how this or that worked were accepted with implicit faith as the last words upon the subject. Now, when the trembling parent is under cross-examination by the junior members of his family he has to mind his p's and q's. Should he give one out-of-date explanation there will be a prompt outcry of protest. "Oh, I say, Dad, that won't wash now, you know. Why, Armstrong showed the other day that that was all rot." It is useless for him to attempt to cover up his ignorance by taking refuge as was his wont of old in long words. The lips of babes and sucklings are familiar now with even longer ones, so that if he attempts this subterfuge he will probably find himself ingloriously hoist on his own petard.

**Hints to the Harassed.**

The safest course, I think, is to let them do most of the talking, adopting oneself an obvious air

of interest, and refusing to be drawn into waters that are too deep to be safe. Let them disparage the circuits that they find upon your bench to their hearts' content. Tell them that you have been waiting for their arrival to try out new things. This if you are wise is the strict truth, for why bother yourself to spend hours over complicated wiring when you can get someone else to do it for you?

Put away your really valuable bits and pieces, but give them the run of the rest and they will do all the donkey work whilst you sit comfortably directing operations, puffing at your favourite pipe. Ask the young directly to do a job of work, and they will shy at it in no uncertain manner; but let them think that they are doing it for their own delectation, and they will labour with a will at the hardest or the most finicky of jobs, and come up smiling at the end of it, asking for more.

**A Wireless Christmas.**

This is to be a wireless Christmas. It may safely be predicted that the present very respectable army of the best part of half a million owners of sets will receive tens of thousands of recruits to its ranks within the next few weeks. Every boy and every girl whose home is not already a wireless one will desire one Christmas present above all others, and that will be some form of receiving set. Now there

is one little human weakness inherent in all fathers: they don't in the least mind buying presents with which they themselves can play.

At past Christmastides if one of your boys suggested a bicycle you were apt to hum! and ha! and to explain that business was rotten. But if he let it be known that his desires ran in the direction of model railways you beamed upon the lad, and forthwith got you to the appropriate shop, where you probably spent far more than you could really afford upon a fascinating outfit. With its help you thoroughly enjoyed Christmas Day, most of which you spent nominally in demonstrating how it should be worked, but really in playing with it, to your son's thinly disguised disgust. There is an old and pathetic story of a boy who confided to his mother that he was going to give Dad a clockwork engine as a Christmas present so that his progenitor might have one of his own to play with.

#### The Wise Child

Things being as they are in the way of masculine human nature, I make bold to prophesy that where the hint that a wireless set would be appreciated comes to the father who has so far not got beyond flirting with the idea that some day he may possibly install one, it will not be a seed cast on stony soil. Rather it will be as a match applied to a fuze train. It will be the little push needed to make him overcome his doubts and to plunge resolutely into the deep end.

But do not, lads and lasses, imagine that you are going to have the free run of your present for a day or two. What happened with the railway outfit will happen in a thousandfold intensified form with the wireless set. His hands, not yours, will twiddle knobs; his ears will grow sore under the all too clinging caress of the cheap 'phones that he has bought, while yours will suffer never an ache. Leave him alone if you have wisdom, encourage him to do these things, denying yourselves for a little while.

#### Bitten

Why does he sit for hours before the table upon which the thing is

placed? Why is his countenance now the playground of seraphic smiles, now a storm centre where frowns and scowls chase one another like thunderclouds? Why do his lips murmur sudden naughty words? Why? Because the germ of radiomania is at work, and in a very short time this will be an acute case.

Bide your time; restrain your youthful impatience; and in a very few days you will see him coming home one evening with a formidable array of parcels, from which he will produce all the components needed for making something really hefty in valve sets. A little tact on the part of the family, a few suggestions thrown out, will transform the most non-wireless father in an incredibly short space of time into a five-valve man complete with loud speaker, so that all can enjoy the entertainment that it brings in.

#### The Aftermath

And so though you will see what the Huns call family-fathers bearing home large parcels that obviously contain wireless gear, coils of wire and the like during the days that immediately precede Christmas, you will meet these same men on the train a week or so later still more burdened with even larger parcels. They will be babbling of reflexes and reaction and rectification. They will beg you to be careful not to bump into them, explaining that their pockets are full of valves. You who can still remember your own first violent attack of the disease will smile benignly and understand.

#### A Hectic Time

Aerials will sprout everywhere. Families will toil unremittingly at the task of stretching the wires which are paradoxically essential for wireless. All kinds of poles, rickety or stout, will be pressed into service. All manner of weird erections will spring into view upon the landscape. Householders will work whilst landlords look on and weep and raise their hands aloft in unavailing protest. Garages will be chock-a-block with accumulators, the owner of each and every one clamouring to have it charged at once—if not sooner.

Such will be the outward and visible signs of the coming of the first real radio Christmas. Within the homes that are Englishmen's castles you might see, if you were provided with X-ray eyes wherewith to pierce their walls, whole families clustered intently round small tables covered with an array of gadgets, before which sits the master of the house fighting his first battle with things that won't go right. Yes, Christmas will be a busy time—and, my word, won't there be some howling in the ether when the army of neophytes gets seriously to work for the first time.

#### Our Little Troubles

We who are seasoned hands at the game will have our little troubles too. Beginners will clutch at us even as drowning men clutch at straws. They will bring us all their worries and will seek to borrow—beware that borrowing!—the essential gadgets that in their haste and flurry they have forgotten. Their feet will be ever upon our doorsteps, their hands incessantly upon our bells. Let us deal gently with them in the season of peace and good will, recalling the days not so long past when we ourselves harried those who were reputed to be experts, seeking to assuage the thirst for knowledge at the fountains of experience.

But our worst ordeal will be when our better halves make up those little parties that are so dear to feminine hearts, and having told everyone what splendid and reliable sets we have, beg us to let the assembled company hear what they can do.

#### Mysteries

Then you may bet your boots that some little rift within the lute will make the music mute or else distort it so horribly that even Philistine ears cannot bear to listen. No one has yet been able to explain how it is that a set which was working perfectly on the previous evening, at the end of which it was merely switched off, the tuning adjustments remaining untouched, can go completely on strike when the filament "juice" is turned on once more on the next day.

THE LISTENER-IN.

# WIRELESS AND A CHRISTMAS PRESENT

## Hints and Tips for the Intending Purchaser

*At this time of the year innumerable people are worrying about what they shall give as a Christmas present to father, mother, sister, brother, son and daughter. Why not make the present a wireless gift? This article contains numerous suggestions to suit all pockets.*

**T**HERE is no question that this will be the first real wireless Christmas in this country. Last year at this time broadcasting had only just commenced, and those who possessed sets could be looked upon as pioneers in a new field. The new form of amusement had not lost its original flavour of technicality, and it was still presumed to be a kind of scientific hobby requiring much knowledge for its successful prosecution. Now we all know the true facts, and thousands of people who have not the slightest technical knowledge nor desire to learn science have been buying and using wireless sets with the greatest satisfaction. Naturally when we are deciding what to give in the way of Christmas presents, wireless in some form or another will come to our mind.

It should not be imagined that a complete set is the only suitable wireless present. Naturally a complete set will be welcomed by those who have not one, and if the giver is prepared to spend a fair sum the gift can be of a most elaborate nature. Comparatively few of us, however, are in the position to spend large sums, and it is to those that we would suggest one of the gifts mentioned towards the end of this article. But first of all let us see what is the best way to approach the problem of buying a complete set.

The best way to start is to take a map and see how near the happy recipient of the set will be from the nearest broadcasting station. If this distance is not more than 10 miles, then you may be sure that a crystal set will be quite good enough for reception on two or three pairs of telephones. Although signals are frequently received at much greater distances

with such a set, one cannot rely on successful reception much beyond this figure. For distances up to 50 or 80 miles a two-valve set will give all that is required, provided the first valve is arranged for what is termed high-frequency magnification. Almost every maker gives some kind of estimate of a satisfactory distance at which his set can be used, but unfortunately a large number make quite ex-

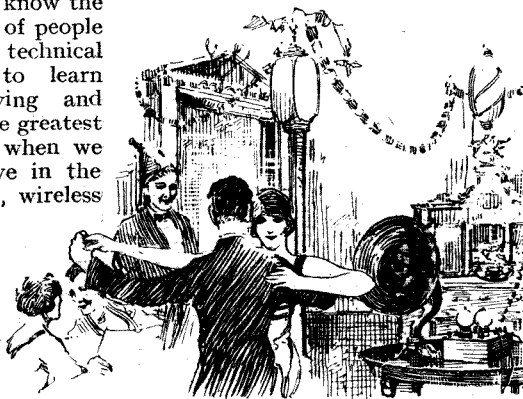

aggerated claims. In general terms it may be said that a two-valve set will give satisfactory reception from the nearest broadcasting station in practically any part of the country, and unless it is desired to receive several stations on the one receiver, this number of valves should be satisfactory for headphone reception; still greater volume, of course, will be obtained with a three-valve set. It is recommended for those who live at extreme distances from the station. Fortunately with the number of broadcasting stations now in operation, comparatively few people are very far away from a broadcast centre.

The next point to decide is whether a loud-speaker is to be used with the set. Now a loud-

speaker is nothing more than a device for distributing loud sounds throughout a room or hall. It is not in any sense a magnifier of itself, and good strong signals are required before it will operate satisfactorily. For this reason no crystal set will operate a loud-speaker well enough to distribute sounds throughout a room no matter how near we may be to a broadcasting station. Valves are therefore all that is required for use in loud-speakers, but there is one exception to this last statement and that is when we use a Brown microphone amplifier, a device which will magnify signals on a crystal set and without valves and will bring them up to the requisite strength for a loud-speaker.

Up to five miles from a broadcasting station, providing a good aerial is used, a single-valve note magnifier attached to a crystal receiver will operate a loud-speaker fairly well. At 10 to 15 miles a two-valve note magnifier will serve for loud-speaker work. These magnifiers do not require any skilled handling and are simply attached to the usual telephone terminals of the crystal set, the loud-speaker being attached to terminals on the magnifier. A valve magnifier will require, in addition to the valves themselves, an accumulator to supply the current to the filament and a high-tension battery. When quoting prices for valve sets it is unusual to include the valve in the set, so that when deciding the cost of the present, bear in mind that valves will be required, and that these will cost a minimum of 15s. each. Accumulators and high-tension batteries are also rather expensive requisites. Valve sets having two or three valves will operate a loud-speaker satisfactorily within 5 to 10 miles of the station, and a good four-valve set will operate a loud-speaker from the



nearest broadcasting station in any part of the country and will frequently bring in several this way when skill has been acquired in handling it.

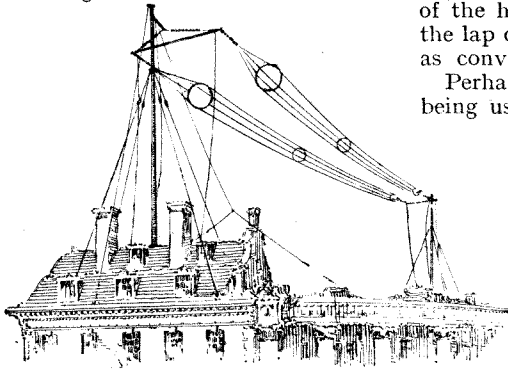

When buying any set, whether crystal or valve, be sure you provide extra telephones. The price quoted for most sets include one pair of telephones, but this, of course, is quite inadequate, as wireless becomes a particularly selfish hobby if only one member of the family can listen at a time. Two pairs should be the minimum number and if there are several members of the family who desire to listen-in, and particularly if the recipients are hospitable folks, three or four pairs can well be included.

So far we have been considering the question of gifts to those who have not a wireless set of any kind. Many people, however, are already provided with some kind of set, and for these we can bring much pleasure by supplementary gifts. Let us consider a few very useful gifts to anyone who has a wireless set.

If the person to whom the gift is to be sent has already a crystal

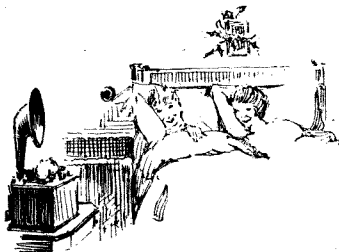

set, find how many pairs of telephones he or she has. In any case an additional pair will always be welcome. A particularly useful

gift is a pair of telephones especially made for ladies; these have not the usual head-bands, but are attached to a special handle which prevents the disarrangement of the hair. The handle rests on the lap or may be held in the hand as convenient.

Perhaps the crystal set is now being used at 15 or 16 miles from a broadcasting station, and the strength may not be quite sufficient for the elder members of the family, who perhaps are slightly deaf. In such a case the gift of a single-valve magnifier with a small accumulator valve and high-tension battery will be a very welcome gift.

A loud-speaker is another welcome gift, but unless it is given with a suitable amplifier, it is of course useless in a set not sufficiently strong to utilise it. Two members of a family can well combine to give one the loud-speaker and the other the amplifier,

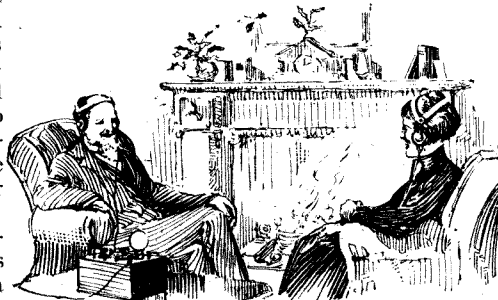

and perhaps a third may join in by providing the batteries, valves, etc. A first-class loud-speaker costs from £5 to £6, while quite serviceable instruments giving good reproduction of somewhat lower quality are obtainable for £2 or £3. It should not be imagined that the larger loud-speakers are only suitable for great halls. The larger instruments are essential if one is to get good purity of tone; the small loud-speakers are really much less efficient. For this reason a gift of a large loud-speaker to those who only have the Baby type will be particularly welcome, and will greatly improve the reproduction. The same magnifier or amplifier does for both instruments, and it should not be imagined that the larger loud-speakers require much more power to operate them.

Even to those people who seem

thoroughly well supplied with wireless matters we can make splendid gifts of useful parts. For example, new valves are required from time to time for every valve set, and



one never knows when a valve may fall through perhaps being dropped or jolted. A present of two or three good valves is always welcome, and if they are of the latest dull emitter type may enable the recipient to effect very considerable saving in current consumption and therefore in cost of upkeep.

Speaking of current consumption suggests one of the best of all Christmas presents in wireless to those who already have electric light in the house. This is a home battery charger; of these there are several varieties, and practically every one is so simple that, to use the proverbial phrase, a child can work it. To charge the accumulator it is only necessary to connect one of these devices to the nearest

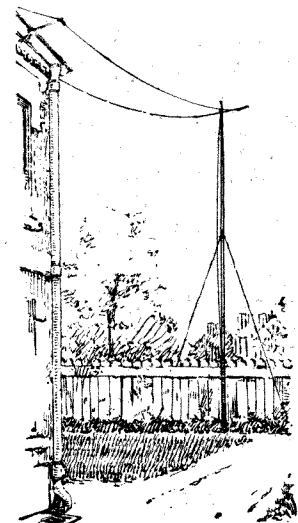

electric light socket and its two output wires to the accumulator. This can conveniently be done in a spare room. If the accumulator is run down at the end of an



evening's programme and it is connected to the home-charging device, it will be fully charged by the time the next evening's programme begins. The cost of running these devices is negligible, as the current consumption is very low indeed. The present writer has had such a device in operation in his house for some six months, very heavy demands being made upon it. It has not given the slightest trouble nor

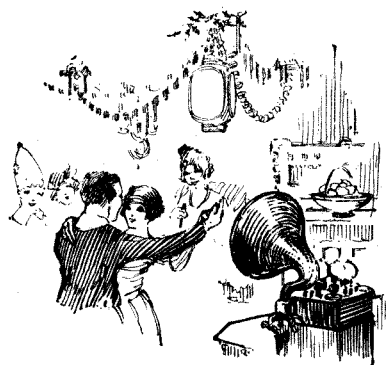

has a single adjustment had to be made from the very day it was installed. Seeing that the wireless user who listens-in every night is probably paying 2s. or 3s. a week for charging his accumulators, the saving possible with such a device is naturally very high. We particularly recommend it as a gift to those people who have a wireless set already.

Other most welcome gifts are spare accumulators, or an accumulator much larger than the recipient is at present using; new high-tension batteries when it is known that those in use are nearly finished; teak carrying cases for accumulators; additional coils when a



set with plug-in coils is in use; wave traps (these are particularly useful to people who are jammed badly); wave-meters (to help the users of multi-wave sets to pick up more distant stations readily); a steel or lattice mast to enable the user to get greater distances with the bigger aerial; hydrometers to test the specific gravity of the acid in the accumulator; and, of course, books on wireless, which always form most acceptable presents. The advertisements in this journal will show that there are available all kinds of books, both elementary and advanced, for every



type of listener, and there should be no difficulty in making a suitable choice. Wireless diaries may quite easily take the place of Christmas cards this year when sending reminders to listeners-in.

Of course when we come to presents for the home constructor there is an endless array at all

conceivable prices. We can, if we wish, send complete sets of parts to enable the home constructor to build a set on definite lines, and, on the other hand, we may send such components as inter-valve transformers, which can always be made use of by the experimenter in all kinds of circuits. The inter-valve transformer is a particularly suitable present for the young experimenter, as these components are on the expensive side and must be "saved up for." When buying wireless components for boys it is just as well to make a few enquiries first, for every boy has some component he longs for and which he cannot at the moment afford.

Just a word in conclusion. When making your purchases, especially by post, confine them to reputable firms. If you have doubts as to the standing of a firm, consult a wireless friend or else the nearest wireless society. These societies are very useful and should be joined by every listener, whether he is able to attend regularly or not.

RADIO PRESS  
INFORMATION  
DEPARTMENT

Owing to a tremendous increase in the number of queries, and the policy of the Radio Press to give expert advice and not merely "paper circuits," it has been found necessary to enlarge our staff dealing with such matters. The slight delay in answering letters will shortly cease. In view of the expense incurred we are reluctantly compelled to increase our charge for replies to 2s. 6d., according to the rules below.

If readers will comply with the conditions laid down they may be assured of more prompt attention.

All queries are replied to by post, and therefore the following regulations must be complied with:—

- (1) A postal order to the value of 2s. 6d. for each question must be enclosed, together with the coupon from the current issue and a stamped addressed envelope.
- (2) Not more than three questions will be answered at once.
- (3) Complete designs for sets and complicated wiring diagrams are outside the scope of the department and cannot be supplied.
- (4) Queries should be addressed to Information Department, Radio Press, Ltd., Devereux Court, Strand, London, W.C.2, marking the envelope "Query."

## A CABINET TWO-VALVE MAGNIFIER

### Using Jack Control

By PERCY W. HARRIS, Assistant Editor.

*In last month's issue full working details were given of the construction of a three-valve set containing two high-frequency valves followed by a detector. In the present article Mr. Harris describes the construction of a handsome two-valve magnifying unit which, when added to the Transatlantic receiver, converts it into a five-valve set.*

IN last month's article, in describing the construction of a Transatlantic receiver, it was pointed out that the three-valve set, although highly sensitive for the reception of distant signals, would not give enough volume to work a loud-speaker satisfactorily save in the immediate vicinity of a broadcasting station. In order that the set may be fully efficient for loud-speaker work I have constructed a further unit in a cabinet of the same size and shape which when placed alongside the Transatlantic receiver enabled one or two more valves to be used for magnification. Although designed as a companion cabinet to the Transatlantic receiver, this note magnifying unit is, of course, equally efficient on any other receiver the reader may possess, and, indeed, forms a useful cabinet for any experimental work. In designing it the following points have been borne in mind:—

- (1). The provision of separate terminals for telephones and loud-speaker with a switch to change in a moment from one to the other (two pairs of telephone terminals are provided).

- (2). As for headpiece reception note-magnifying valves are rarely needed, with this set provision is made to listen on the three first valves alone without disconnecting any wires.

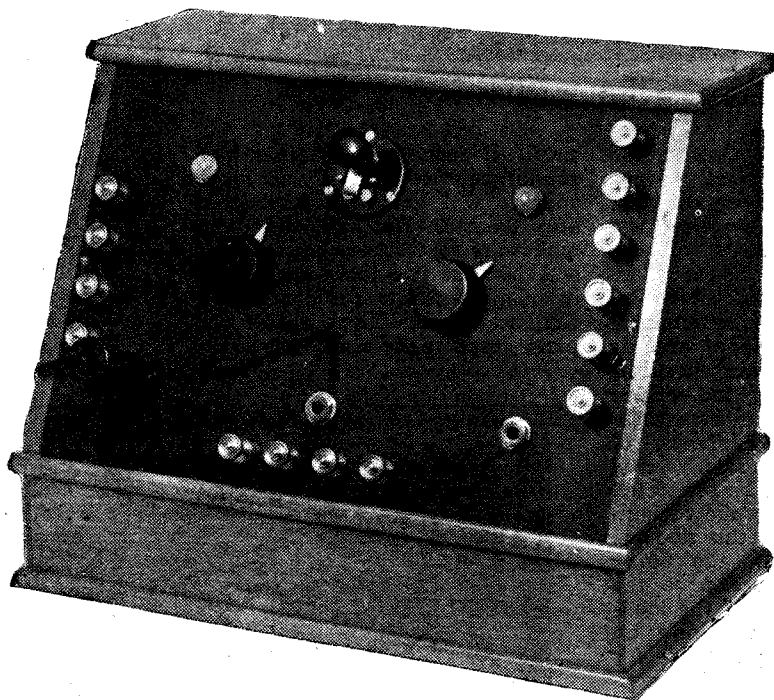

*Although designed as a companion cabinet to the Transatlantic receiver, this cabinet amplifier will work as well with any other receiver.*

- (3). In order to facilitate the cutting in and out of the note-magnifying valves, at the same time economising with the current, a plug and jack are provided which perform the double function of connecting the telephones or loud-speaker in the right circuit, at the same time disconnecting the filament

supply of those valves not in use.

- (4). Bridging terminals are provided so that the same low-tension supply serves for both cabinets.

- (5). In order that one may get the best out of the note magnifying valves separate high tension terminals are provided, so that a higher voltage can be placed on the note magnifying valve than is used on the previous valves.

- (6). Provision is made for a variable grid bias on the last valve.

The general appearance of the instrument can be gathered from the first photograph in this article. It will be seen that the front panel carries 14 terminals—4 on the left, 6 on the right and 4 at the bottom. In addition to these terminals there are: a single pole

2-way switch, which connects the output either to the telephones or to the loud-speaker; two small opal windows to show that the valves in the interior of the cabinet are alight; three jack sockets; two filament resistances and one plug which is connected to a flexible cord entering the middle of the panel. The terminals on the left are as follows (reading from the top):



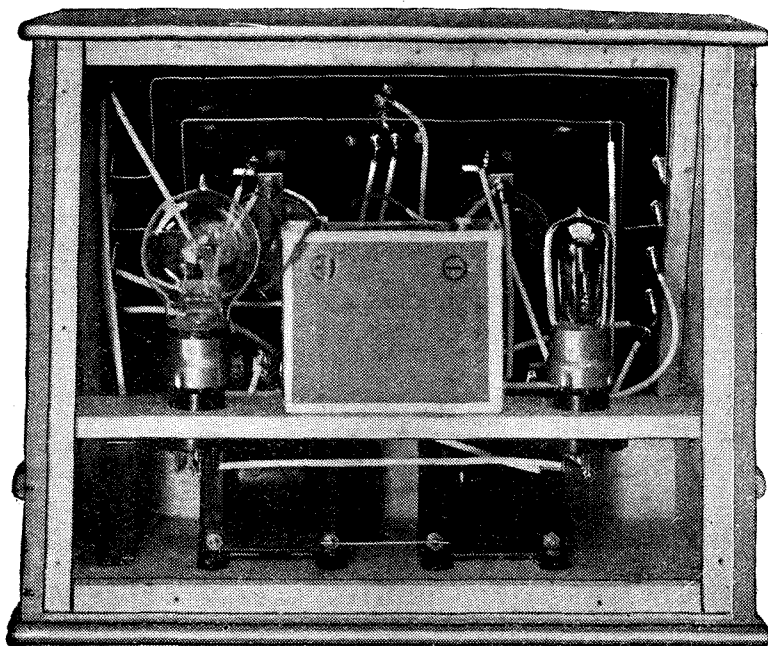

*Back of the cabinet removed to show disposition of parts.*

Low-tension positive, low-tension negative, input (plate) input (positive). These are so disposed that they come alongside the corresponding terminals of the Transatlantic receiver, so that short lengths will bring the tuning in. On the right-hand side the terminals reading from the top are as follows:— High-tension positive, high-tension negative, low-tension positive, low-tension negative (these two terminals are duplicates of those on the opposite side, so that the accumulator can be connected to either side at will); the remaining two terminals on this side are for the loud-speaker, the upper being that for connection to the pole marked positive of the loud-speaker. The four terminals on the bottom of the panel are for the telephones, these being connected in parallel. The first and third (reading from the left) are for the positive poles of the telephones. When connecting either the telephones or loud-speaker to this instrument, it is advisable to follow this rule and to look to see whether your phones are marked with a plus mark on one of the leads. The loud-speaker should be similarly marked. If the phones and loud-speaker are so connected, the steady plate current will tend to increase rather than decrease the magnetism of the permanent mag-

nets. If connected the other way round, your telephones and loud-speaker will gradually lose their sensitiveness. Not all the best makes are so marked, however.

Above the two jacks are a pair of filament resistances controlling the two valves. These are of the plain type and need have no

vernier adjustment as this is quite unnecessary with note-magnifying valves.

Looking at the photograph which shows the back of the instrument removed, we see inside a shell which carries two valve sockets. Between these two is placed a  $4\frac{1}{2}$  volt battery which places a negative bias on the grid of the last valve. The two intervalve transformers are placed side by side in the space between the jacks which project from the top of the panel. The wiring is carried out with No. 22 tinned copper covered with Systoflex tubing, the sole exception being two wires of No. 18 bare tinned copper which act as bus-bars across the back of the instrument and join the two pairs of low-tension terminals.

#### List of Components Required

Here is a complete list of components required. As I frequently receive letters following the publication of my articles, asking for the names of the exact components used, I give them below, but it must be understood that there are many different makes of the same component and practically any good make will suit just as well.

1 polished mahogany cabinet of the same dimensions as that described in the previous article for the Trans-

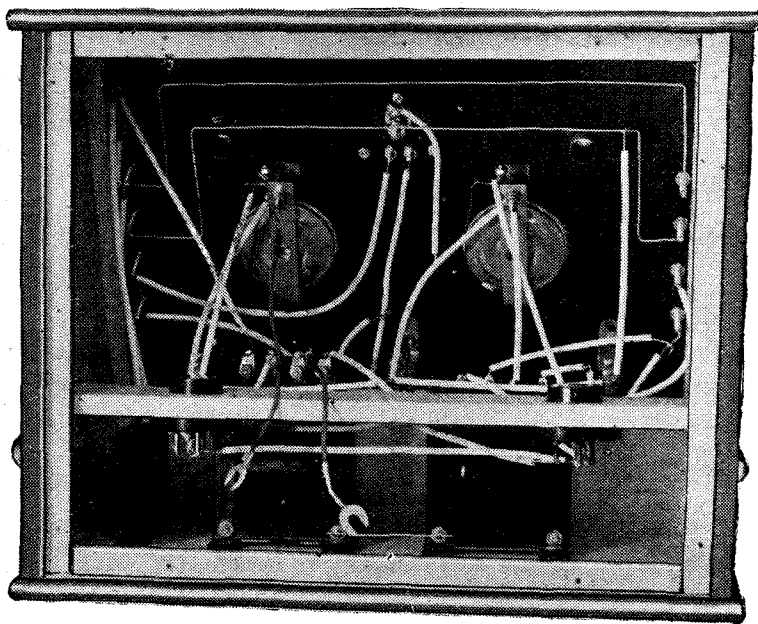

*Another view of the back with valves and biasing battery removed.*

atlantic receiver. (Scientific Appliances.)

- 1 ebonite panel, 12 in. by 8 in. by  $\frac{1}{4}$  in. (this can be purchased ready cut and matted, thus saving a good deal of time and trouble for the home constructor).
- 14 pairs of terminals and nuts.
- 2 Igranic resistances.
- 2 Opal valve windows (Elwell).
- 2 "A" type valve sockets with flanges.
- 1 single pole 2-point switch (Bowler-Lowe).
- 2 D.F. jacks (Elwell).
- 1 S.M. jack (Elwell).
- 1 plug (Elwell).
- 2 good intervalve transformers (in this case 2 Igranic shrouded patterns were used).
- 1 Mansbridge condenser, 1  $\mu$ F. (Radio Instruments).
- About 4 yards of Systoflex tubing (McMichael).
- A quantity of No. 22 tinned copper wire.
- About 1 yard of No. 18 tinned copper wire.
- 2 short lengths single electric lighting flex.
- 2 spade soldering tags.
- 1 strip  $\frac{3}{8}$  mahogany, 12 in long by 2 in. wide.

#### Use of Plugs and Jacks

The plug and jack method of control of low-frequency and detector valves is little used by amateurs, probably because of the lack of detailed information as to the advantages and connections of these components.

They are a great convenience, as will be seen of a moments examination on the possibilities of the present instrument. For example, when we plug into the left-hand jack socket, the telephone; or loud-speaker are substituted for the primary of the first intervalve transformer, and one thus listens on the Transatlantic receiver alone, without the magnifier. When thus listening, the circuits of both valve filaments in the magnifying unit are broken and thus the valves do not light.

On pulling out the plug the telephones or loud-speaker are immediately disconnected. Spring contacts in the first jack come together and connect the primary of the first intervalve transformer in circuit. On plugging into the middle socket, the filament circuit of the first note magnifying valve is

closed and the telephones or loud-speaker are inserted in the plate circuit of the first note magnifying valve, the action of pushing the plug into the jack disconnecting the primary of the second intervalve transformer and substituting for it the telephones or loud-speaker. On pulling out the plug from the central socket spring contacts come together, the primary of the second intervalve transformer is substituted for the telephones or loud-speaker and, on inserting the plug into the last socket, the filament circuit of both note magnifying valves is now closed, the valves light and the telephones

#### Details of Construction

Although the wiring of this receiver is somewhat complicated owing to the introduction of jacks, it will not be found difficult to wire up if the reader carefully studies the photographs and diagrams accompanying this article. The first step should be to remove the surface skin from the ebonite in the usual manner with emery paper (if one has not purchased a panel ready finished), and to mark out on the back the positions of the various parts. As it is likely that the reader may care to use identical parts in his instrument, I give in

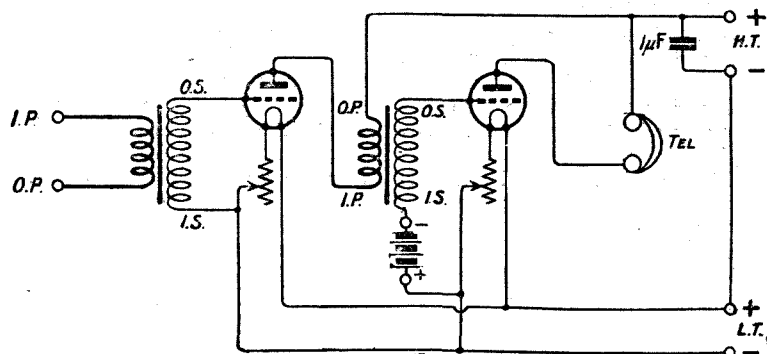

The circuit diagram.

are inserted in the plate circuit of the last valve. It will thus be seen that very rapid interchange of connection is possible with the minimum of trouble. The switch at the top of the cabinet is also very useful, as when signals become too strong for telephones one can immediately place the loud-speaker in circuit without disconnecting or connecting any further leads.

The sole disadvantage of the filament control jack system is that the life of the valves is somewhat shortened by throwing the full current on to them all at once. However, provided that one does not misuse this system by too frequently plugging in and out it will not be found that the valves are appreciably injured. Those who wish to make the most of their valves, are advised to switch off with the filament resistances as well, so that when connecting a valve resistance is slowly to be cut out until the right value of filament current is obtained. Personally I am willing to sacrifice a little of the life of a valve for the added convenience obtained.

this article a dimensioned plan of the rear of the panel.

The 2-way switch used for changing from telephones to loud-speaker is purchased ready mounted on a disc of ebonite. To insert this in the panel it is necessary to cut a hole of  $1\frac{3}{8}$  in. diameter. This can easily be done by scratching a circle of this diameter with a pair of dividers, drilling a single hole somewhere near the line and cutting out the disc of ebonite with a fretsaw. Many readers will be unaware of the fact that the fretsaw is an excellent instrument for cutting ebonite and no difficulty whatever will be found in cutting circular holes of any size with its aid. Of course, if the reader desires he can mount the switch straight on to the ebonite in the usual way, and many will prefer to do so; but the particular 2-way switch mounted on its circular base of polished ebonite makes rather a handsome addition to the panel. It is secured in place with three 6 B.A. metal screws (countersunk heads) passed through the disc and through clearance

holes in the ebonite panel. To save tapping these holes they can be made of such a size that the screws pass easily through and are held in place by lock nuts at the back. It will probably be necessary slightly to enlarge the holes in this disc in order to admit the 6 B.A. metal screws, as this particular line of components is primarily designed for mounting on wood panels.

No difficulty will be found in mounting the Igranic resistances, as a cardboard template for drilling purposes is provided with each resistance. As the holes for the jacks are probably larger than that of any drill the reader may have conveniently in hand, these holes also should be cut out with a fretsaw. A slight irregularity in cutting them does not matter, as the sockets are flanged and provided with a metal ring which will cover any slight irregularity. The two holes for the valve windows should also be cut out with a fretsaw. These also have flanges which will cover up any slight irregularity in cutting the holes. No special means are required of secur-

ing the windows, as they push into place and are held tight by expanding strips.

When all the panel components are in place see that the lock nuts for the terminals and other components are quite firm and then with a smooth file remove the tops of all screws, etc., which have to be soldered, so as to present a bright surface. Place a tiny touch of fluxite on each point to be soldered and with a hot soldering bolt tin each point carefully. After tinning and when the metal has cooled retighten all nuts, otherwise later on you may find them becoming loose. Now place the panel temporarily in position. It will be found that the jacks are projecting at an angle into the cabinet. Take your two intervalve transformers, place them side by side so that they fall between the jacks. Mark the positions, remove the panel and secure the transformers in place by means of suitable wood screws. Next take the wooden strip which forms the shelf to carry the valve holder and at a distance of  $2\frac{1}{2}$  in. from each end cut out a

circular hole exactly 1 in. in diameter; cut this as neatly as you can either with a brace and bit or a fretsaw. Now take the flanged valve sockets and push them through from below, so that the flange is below and not above the shelf. Three wood screws will now hold each socket to the shelf, leaving the top of the socket projecting through the board. Do not secure the shelf in place until later.

If you examine the wiring diagrams you will see which of the wires you can connect up before placing the panel in position. With the panel on the table and the No. 22 tinned copper wire, together with the Systoflex tubing quite handy, make the connections between those terminals on the panel which are joined together. On every terminal which is joined to a component not on the panel solder a length of wire about a foot long and leave these loose. In the case of the low-tension terminals you should connect them together with the No. 18 bare tinned copper wire, which, being stiff, can

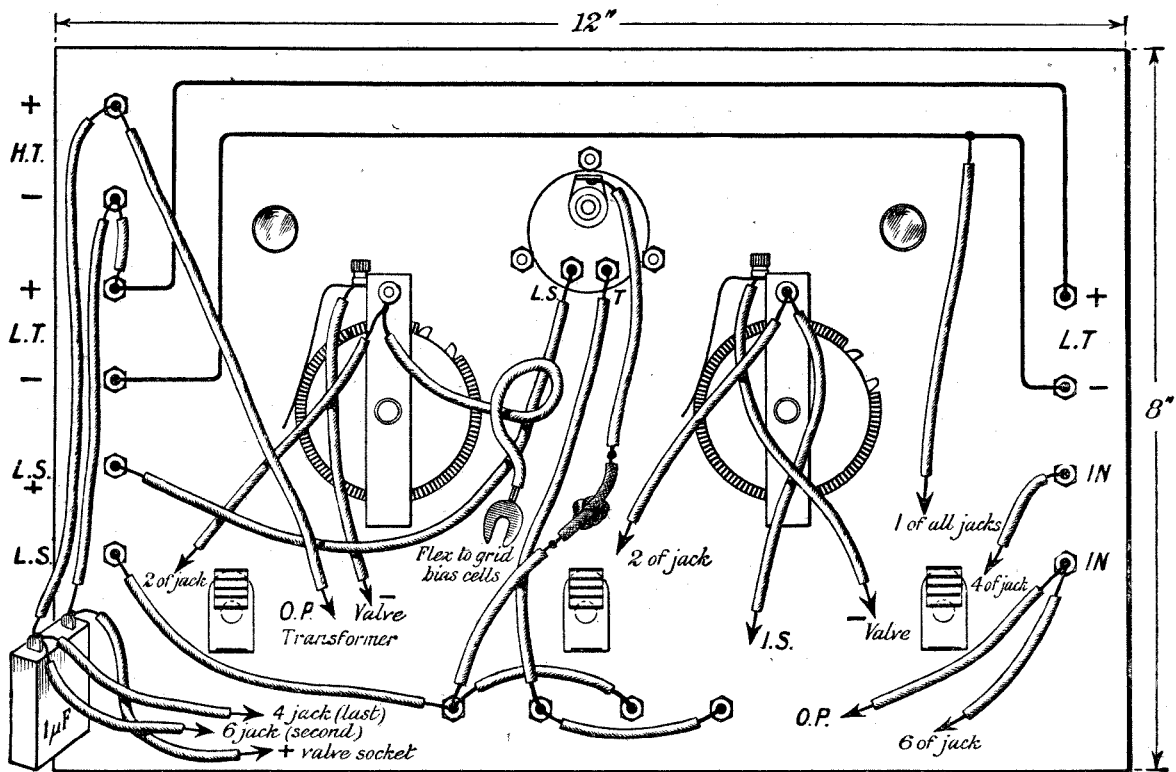

In this article an entirely new method of showing the wiring is presented for the first time. This diagram must be used in conjunction with the further diagram on the next page.



be bent and made to stand away from the panel, switch, etc.

Now fix the 1  $\mu$ F fixed condenser in the position shown on the left of the bottom of the box looking from the back and tin its lugs preparatory to soldering. Also connect on each of the terminals of both intervalve transformers similar lengths of wire for connection. Take the valve bridge and tin the four pins of each valve socket and secure it in place at a height of about 3 in. from the bottom of the box. Screws from the outside of the box will serve for this purpose.

The next step is to place the panel in position and to secure it in place with the necessary screws. Pull all the odd lengths of wire out through the back of the box. (It will look in the most inextricable mess with loose wires everywhere, but do not mind this. However complicated it may look you will

find it by far the simplest method of wiring up a receiver on these lines.)

Before beginning to wire up the receiver, take your plug and a piece of silk-covered electric lighting double flex, about a foot long. Bare each end of each wire and solder to the two wires at one end two short pieces of thick wire. This is necessary as the particular plugs are made to take the tips of telephone cords, and only the standard size of wire used on these tips will do. For this reason I would suggest that you obtain two tips from old telephone cords. When these are in place you can attach this flex to the plug quite easily. Pass the other end of the double flex through the hole in the panel made to take it, and when through tie a knot on the other side to prevent the cord being pulled back. The two ends of this flex, as you will see from the

drawing, are connected one to the switch arm and the other to one of the telephone terminals and to the lower loud-speaker terminal. I should mention here that when you have completed all of the wiring it will be necessary to test with a pair of telephones and a dry cell to find whether you have connected the correct wire to the positive terminal of the telephones and loud-speaker. To do this take a pair of telephones, connect one lead to the dry cell terminal, the other to the high-tension terminal (of course no H.T. battery will be connected during this test), leaving the remaining terminal of the dry cell free. Now take the dry cell in your hand and tap the free terminal against the positive loud-speaker terminal on the right of the panel looking from the front. If you hear a loud click when the contact is made and broken your connection is correct. If the click

(JACK DIAGRAM)

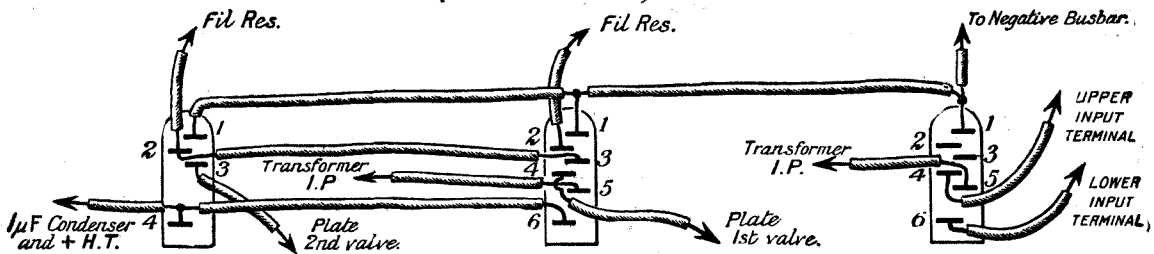

(VALVE STRIP DIAGRAM)

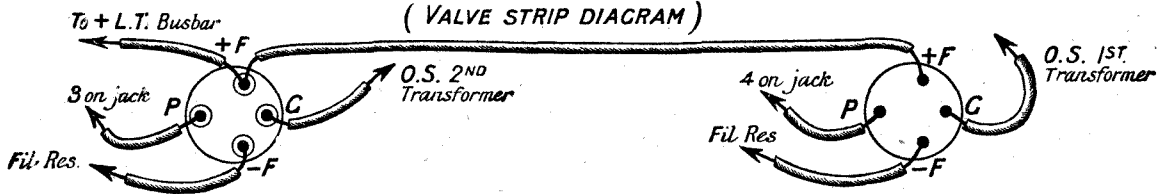

TRANSFORMER DIAGRAM

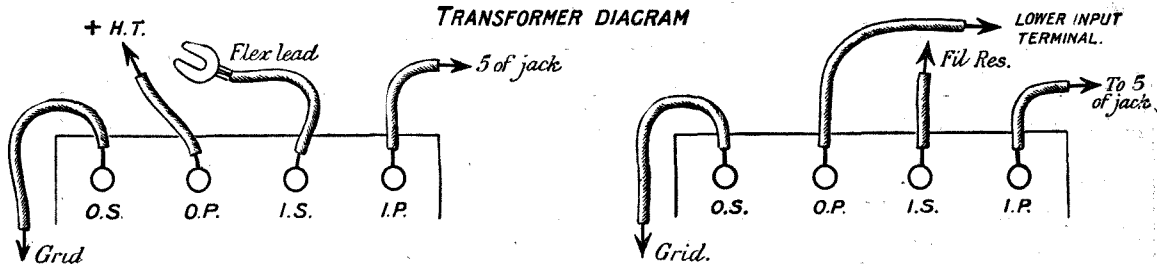

If these three diagrams are studied in conjunction with the previous diagram the wiring will be quite clear. Whatever the arrangement of transformer terminals, be sure that your leads go to the I.P., O.P., etc., in this way.

is only heard when you tap the lowest or negative loud-speaker terminal, you should disconnect the flex from the plug and reverse the connections. A new trial will now show you that the positive terminal of the H.T. supply is connected to the positive loud-speaker and telephone terminals.

Owing to the complexity of the wiring it is not possible to give the ordinary wiring diagram in its usual form. For this reason special and novel wiring diagrams are given. These diagrams should give all necessary information for connecting up.

With the diagrams in front of you, begin on the right-hand side of the instrument (looking from the back) and, taking a wire, stretch it across to the point to which it is to be soldered. Measure this length, cut a length of Systoflex tubing, slip it over and then, with a touch of the soldering iron, join the wire in place. Directly you have soldered the particular wire, cut off the surplus length. If you take one wire after another and follow this method you will find it a simple way of joining up, and as you progress the wiring will become simpler, as the connections will be more obvious. In those cases where you have a wire on each of the two terminals to be joined, use the most convenient and remove the other. Be very careful to cut the lengths of the systoflex tubing correctly, so that the bare wire may be covered up so as to prevent short circuiting. It is quite permissible to use two quite different makes of transformer for the two stages—indeed, some constructors prefer to do this, as there is sometimes less chance of unwanted audio-frequency resonance when this is done. The best

makes of transformers, however, can be used in pairs perfectly satisfactorily.

It will be noticed that the filament portions of the first jack are not used in this set. If they were used the whole of the current for the three first valves would need to be made and broken through one small contact, which is not advisable. If, however, the reader has only a single valve prior to this cabinet, there is no reason why the filament of the first valve should not be controlled in this way. For one shilling Messrs. Elwells issue an excellent book of diagrams showing how to use these jacks in every conceivable manner in all kinds of circuits, and if the reader desires further information in this regard he is advised to obtain the book in question.

It will be noticed that there are two flexible leads in this set, one is joined to the second filament resistance and the other to the I.S. terminal of the second intervalve transformer. To the ends of each of these two flexible leads spade terminals are soldered. These leads go to the positive and negative of the grid biasing battery (an ordinary Ever Ready No. 126 battery). This battery will last for a year or more before requiring renewal, as very little current is taken from it. The lead which goes to the filament resistance is connected to the positive of the battery and that which goes to I.S. of the second transformer to the negative terminal. No special means are provided of securing this battery in place, as it is presumed that the instrument will be kept in one position, but if it is desired to hold it firmly a piece

of tape can be passed over the battery and round the underside of the shelf and tightened up. This will hold the battery firmly in position. It will be noticed that the drop in voltage in the filament resistance is used to add to the grid bias. This is a useful method and is perfectly justifiable as the adjustment of grid bias is *not* critical and variations of the filament resistance do not appreciably affect results.

When you have finished the wiring the instrument will be ready for test. The simplest way to test it is to connect a pair of telephones to the input terminals and another pair of telephones to the loud-speaker terminals, placing the switch on the loud-speaker point (the right-hand stud).

Connect up the batteries and plug into the central socket. The first valve should now light and you should be listening on one note magnifying valve. Now place your watch on one of the earpieces of the telephones connected to the input terminals and listen on the out-put telephones. You should hear the ticking quite plainly. Withdraw the plug and plug into the second; the second valve as well as the first should now light and the ticking of the watch should be very much louder. You should hear nothing but this ticking and there should be no rustling or scraping noises if all is well. If this works satisfactorily the instrument can be connected up to the Transatlantic or other receiver. Use about 100 volts on the magnifier. Any good hard valves will do. Dull emitters (except the LS 5 or similar power valves) are not recommended in this set.

## NOTICE.

The Next Issue of MODERN WIRELESS will be a special "Long Distance" Number.

Order early to avoid disappointment.

# WHAT TO DO WITH THREE VALVES

By JOHN SCOTT-TAGGART, F.Inst.P.

Author of "Radio Valves and How to Use them," "More Practical Valve Circuits" and "How to make a Two-valve Receiver Using the ST.100 Circuit."

This article by the Editor will give the experimenter and constructor many ideas for a three-valve set.

**T**HE three-valve set has become so popular that I propose in this article to discuss some of the different circuits which may be arranged with three valves.

Personally, I am not so enthusiastic about three-valve circuits as I used to be. The two-valve ST100 receiver gives such remarkably good results for ordinary purposes that the idea that three valves must be used to obtain loud-speaker results no longer holds. My own idea of a three-valve set is one in which there are two stages of high-frequency amplification and which is provided with specially selective tuning arrangements to cut out local interference.

The ST 100 circuit, of course, involves a stage of high-frequency amplification, reaction, crystal detection and two stages of low-frequency amplification. The circuit is therefore equivalent to about three and a half ordinary valves. When the set is specially designed, however, it is possible to obtain a peculiar

form of low-frequency reaction which enhances the signal strength still more. With a properly designed ST100 set, and the circuit is by no means always sufficient to guide the constructor, remarkable results are

obtainable, and the average person will cease to long for a three-valve set.

On the other hand, there are many who prefer to use what might be termed a "straight circuit," i.e., in which each valve carries out one

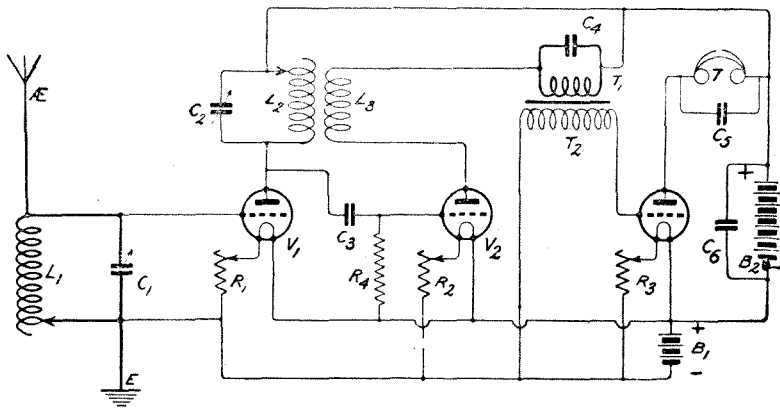

Fig. 1.—The most popular circuit.

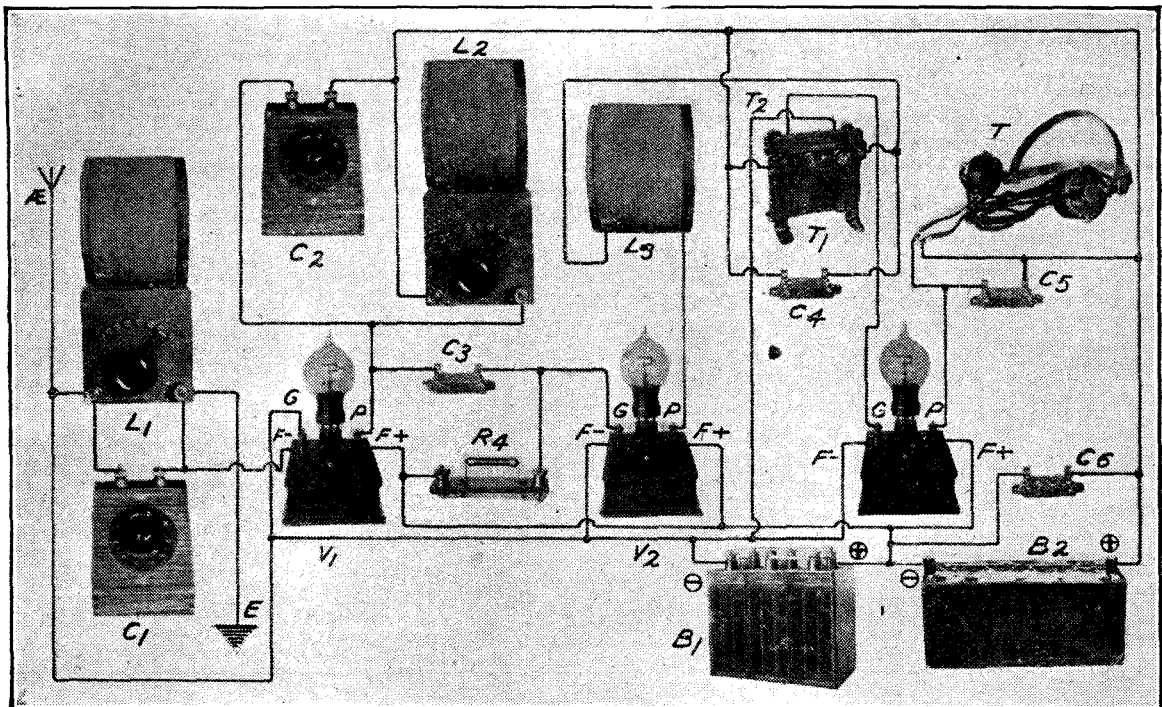

Fig. 2.—The first figure shown pictorially.

duty. There are others who have a violent dislike for crystal detectors. As a matter of fact, it is only within the last month that I have myself worked with a crystal detector which I really liked, and since then crystal troubles have disappeared.

In this article I propose to confine myself almost entirely to straight circuits. Many more of these, together with innumerable dual amplification circuits of a practical nature, are given in my new book, "More Practical Valve Circuits" (ST68—ST151) which is a continuation of my other circuit book "Practical Wireless Valve Circuits" (ST1—ST67).

The most popular circuit using three valves is unquestionably the one in Fig. 1. Nearly all the manufacturers of three-valve sets have copied this circuit.

Not only is the circuit very sensitive, but the tendency to self-oscillation is less than in the case of most circuits. The restriction regarding reaction on the aerial circuit or closed receiving circuit has now been removed, although it is still forbidden to operate the set carelessly in such a manner that self-oscillation sets in and waves are radiated from the aerial. The raising of the ban on reaction on the aerial circuit applies to commercial sets as well as to home-made sets, and it is

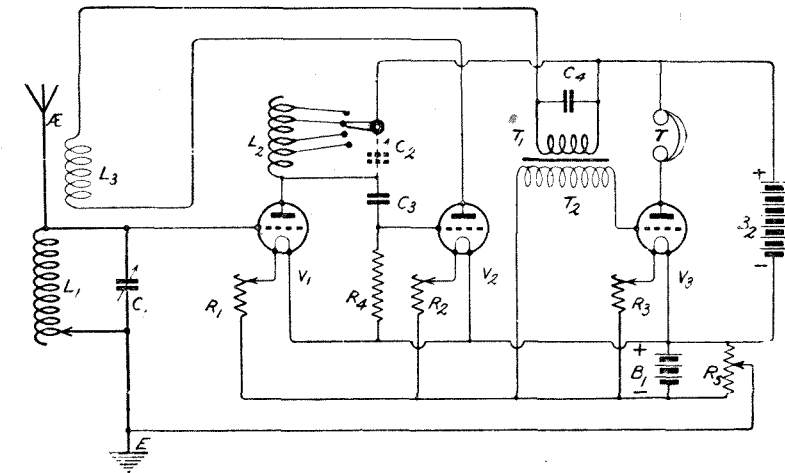

Fig. 3.—Another very popular circuit.

to be sincerely hoped that these extra privileges will not be abused by the users of the sets. The experimenter will welcome the raising of the ban because it enables him to try out an entirely new set of circuits. It must not, however, be imagined that by being permitted to use reaction on the aerial circuit when receiving broadcasting a great increase in sensitivity is going to be obtained. On the

her hand, many circuits using reaction on the aerial are not only very much more difficult to handle, but give results which are inferior to those obtained on a circuit in which reaction is applied to a tuned anode circuit, as in Fig. 1.

Explanation of Fig. 1.

In Fig. 1 we have a tuned aerial circuit which consists of the aerial

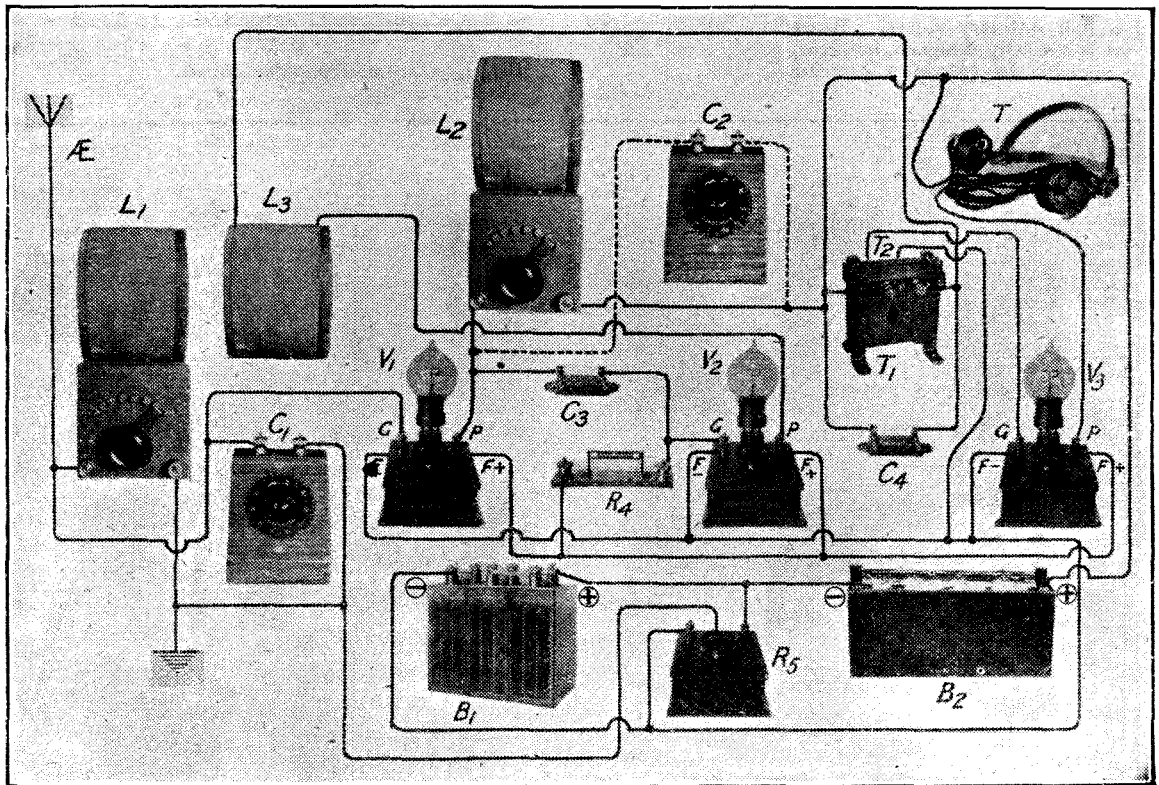

Fig. 4.—Figure 3 shown photographically.



inductance  $L_1$ , shunted by the variable condenser  $C_1$ . The variable condenser  $C_1$  could, of course, be connected in series with the aerial. In the anode circuit of the first valve we have the inductance  $L_2$  shunted by a variable condenser  $C_2$ . The anode of the first valve is connected to a grid condenser  $C_3$  of  $0.0003 \mu\text{F}$  to the grid of the second valve, while a gridleak  $R_4$  is connected between the grid and positive terminal of the accumulator. The resistance  $R_4$  is preferably a variable one.

In the anode circuit of the second valve we have the reaction coil  $L_3$  and a primary  $T_1$  of the step-up interval transformer  $T_1 T_2$ . The primary  $T_1$  is shunted by a condenser  $C_4$  of  $0.002 \mu\text{F}$  capacity. It is to be noted that the left-hand side of  $T_2$  is connected to the negative terminal of filament accumulator. In the anode circuit of the second valve we have the telephone receivers  $T$  which may be shunted by a condenser  $C_5$ . The value of the condenser  $C_5$  will depend upon the telephones used. Generally speaking, it is not necessary to connect a condenser across the telephones, but when using a loud-speaker music is generally made more mellow by connecting a condenser which may have a value of from  $0.002 \mu\text{F}$  to  $0.05 \mu\text{F}$ . In the figure, the high-tension battery  $B_2$  is shunted by a condenser  $C_6$ ; this condenser has a value of 1 microfarad at least, and eliminates various crackling noises which are sometimes

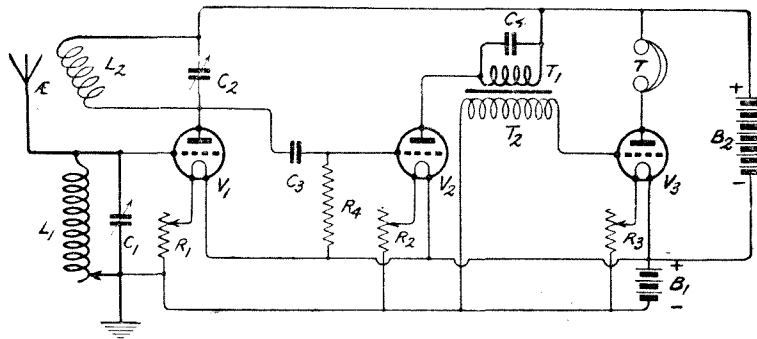

Fig. 5.—A good circuit now permissible.

heard when a faulty, or slightly faulty, high-tension battery is employed.

Fig. 2 is a photographic representation of the components in the circuit and their wiring. The reader may be interested to know what values the different components should be. As regards the aerial inductance  $L_1$ , the value of this will depend upon whether the variable condenser  $C_1$  is connected in parallel with it or in series with it. When plug-in coils are used, a No. 25, 35, or 50 is used for  $L_1$ , while  $L_2$  is either a No. 50 or No. 75 plug-in coil. The reaction coil  $L_3$  will usually be a No. 75 plug-in coil. If it is preferred to use tapped inductances, the coil  $L_1$  may consist of 50 turns of No. 26

a  $3\frac{1}{2}$  in. tube. Tappings are taken at the 10th, 15th, 20th, 25th, 30th, 35th, 40th and 50th turns. The condensers  $C_1$  and  $C_2$  are of  $0.0005 \mu\text{F}$  capacity. If the condenser  $C_1$  is in series with  $L_1$ , then this latter coil may conveniently consist of 100 turns of No. 26 gauge double cotton covered wire wound on a  $3\frac{1}{2}$  in. cardboard tube. Tappings are taken at the 30th, 45th, 60th, 75th and 100th turns.

The inductance  $L_2$  may consist of 70 turns wound on a 3-in. tube, the wire used being No. 26 gauge, double cotton covered. Tappings are taken at the 30th, 50th and 70th turns. The reaction coil  $L_3$  may consist of 35 turns of No. 26 gauge double cotton

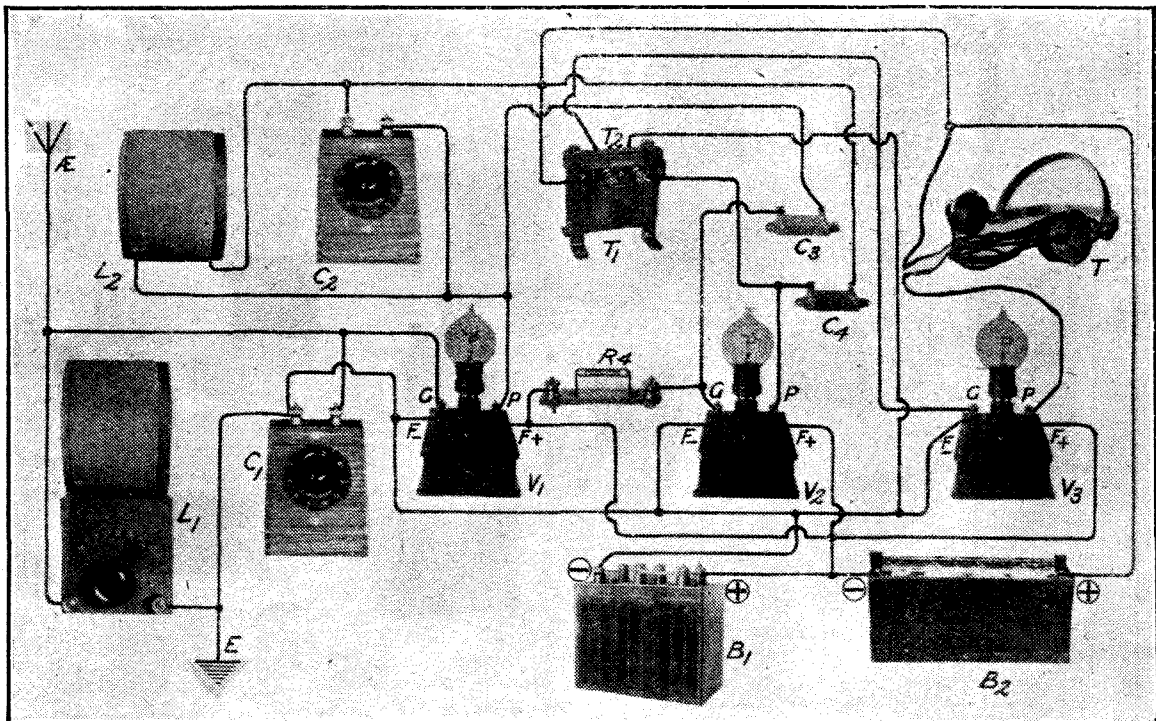

Fig. 6.—How Figure 5 appears when connected up.

covered wire wound on a 3 in. tube. This reaction coil may slip over the coil  $L_2$  which might be wound at one end of a cardboard tube about 8 in. long; the reaction coil  $L_3$  may be wound on a cardboard tube, about 2 in. long, this slipping over the other tube.

It sometimes happens when using this type of circuit that the first valve oscillates. To lessen the chance of this happening, the connection which at present is taken from the circuit  $L_1 C_1$  to the negative terminal of the filament accumulator, is made to a sliding contact on a potentiometer connected across the filament accumulator. A condenser of  $0.002 \mu\text{F}$  capacity may be connected between the slider and the negative terminal of the accumulator if desired.

**Another Popular Circuit**

Another very useful circuit using three valves is illustrated in Fig. 3. In this circuit the first and second valves are coupled by means of a variable inductance  $L_2$ ; this is generally termed "reactance capacity coupling,"  $L_2$  being the reaction and a grid condenser  $C_3$  being the capacity. A fixed or variable gridleak  $R_4$  is connected across the grid and filament of the second valve. In the anode

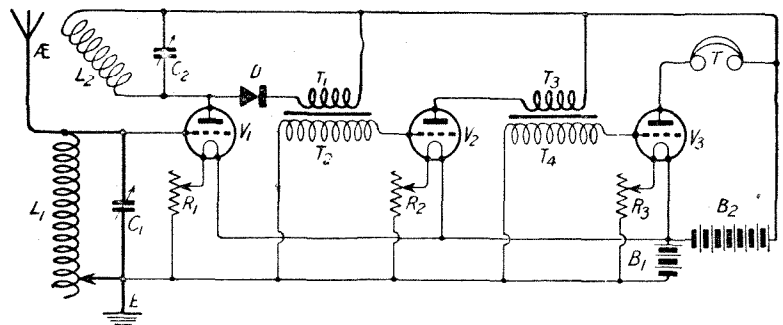

Fig 7.—One of the best possible "straight" circuits.

circuit of the second valve we have the reaction coil  $L_3$  and also the primary  $T_1$  of a step-up intervalve transformer  $T_1 T_2$ . The primary  $T_1$  is shunted by a condenser  $C_4$  of  $0.002 \mu\text{F}$  capacity. The reaction coil not only introduces reaction into the aerial circuit which includes  $L_1 C_1$ , but also into the circuit  $L_2$  which is shunted by the capacity of the anode to filament path in the first valve and the grid to filament path of the second valve, together with the natural self-capacity of the inductance coil  $L_2$ . A considerable number of tappings

should be employed, although when no reaction is being used, a reactance does not need to have more than a few tappings. If a vernier condenser  $C_2$  of very small capacity is connected across  $L_2$ , an increase of signal strength is easily obtained.

As regards the values of components for this circuit, the following particulars should prove of value. The aerial inductance  $L_1$ , if of the plug-in type, may be a No. 25, 35 or 50 coil. If the condenser  $C_1$ , which has a maximum capacity of  $0.0005 \mu\text{F}$ , is in parallel with the inductance  $L_1$  and

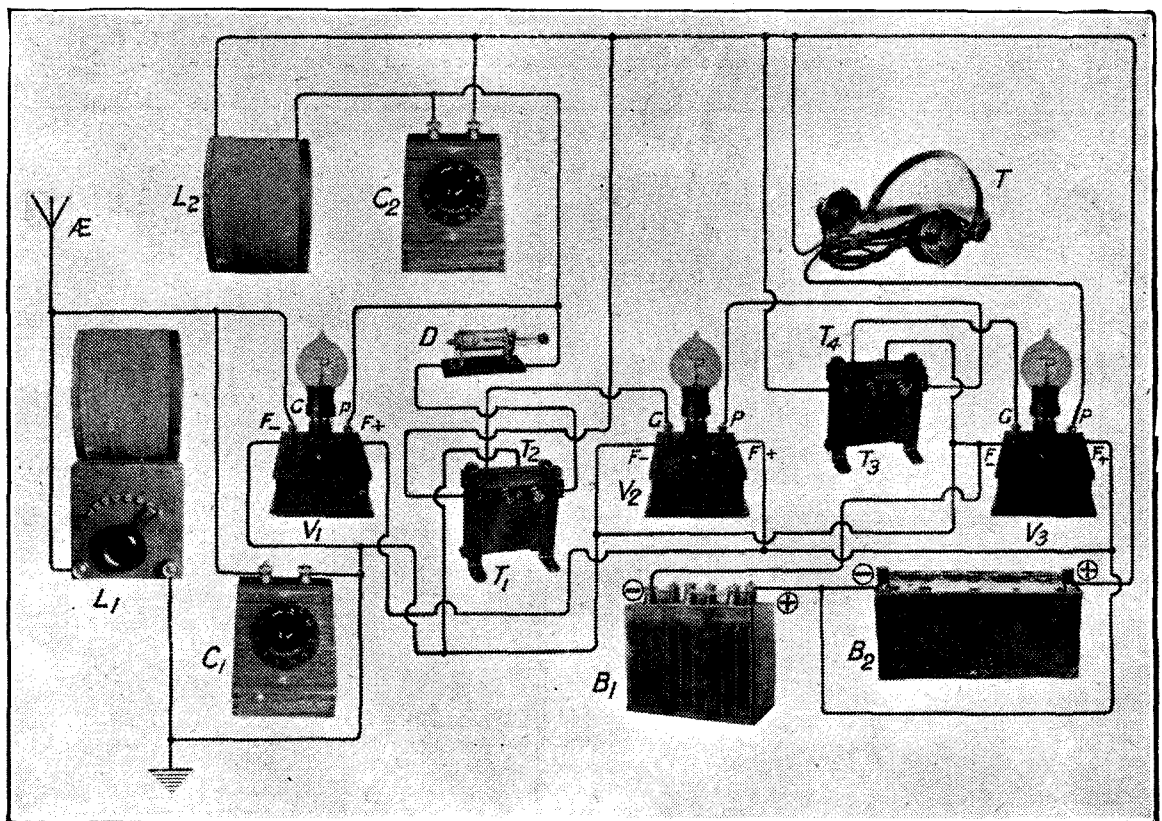

Fig. 8.—The above circuit shown pictorially.

it is desired to use a tapped coil, the following tapings will be found suitable for covering the wave-length ranges, 250 to 650 metres on any aerial of ordinary dimensions. The tapings are taken at the 10th, 15th, 20th, 25th, 30th, 35th, 40th and 50th turns. If the condenser  $C_1$  is to be included in series with the inductance  $L_1$ , the latter may consist of 100 turns tapped at the 30th, 45th, 60th, 75th and 100th turns. These turns represent the number wound with No. 26 gauge double cotton covered wire on a cardboard tube 3½ in. in diameter. The reaction coil  $L_3$  may be a No. 35 plug-in coil or may consist of 25 turns of No. 26 gauge double cotton covered wire wound on a 4 in. cardboard tube. The reactance coil  $L_2$  may consist of at least 150 turns of No. 26 gauge double cotton covered wire wound on a 3½ in. tube and tapped at the 50th, 60th, 70th, 80th, 90th, 100th, 110th, 120th, 130th, 140th, 150th turns.

It will be noticed that in Fig. 3 connection is made between the earth and a slider on the potentiometer  $R_5$ , which is connected across the filament accumulator  $B_1$ . Telephones  $T$  are

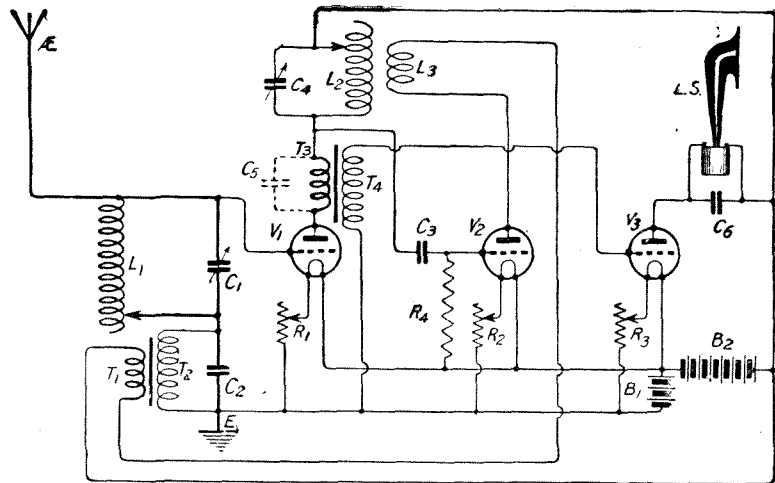

Fig. 9.—An interesting dual circuit.

connected in the anode circuit of the third valve and may, if desired, be shunted by the fixed condenser  $C_5$  of Fig. 1. A loud-speaker, of course, may, in this and the other circuit illustrated here in this article, be used in place of the telephones.

**A Simple Three-Valve Circuit**

One of the simplest three-valve circuits is that illustrated in Fig. 5. The results obtainable are equal to those which the Fig. 1 gives. Not only is the Fig. 5 circuit a very simple three-valve arrangement, but it is

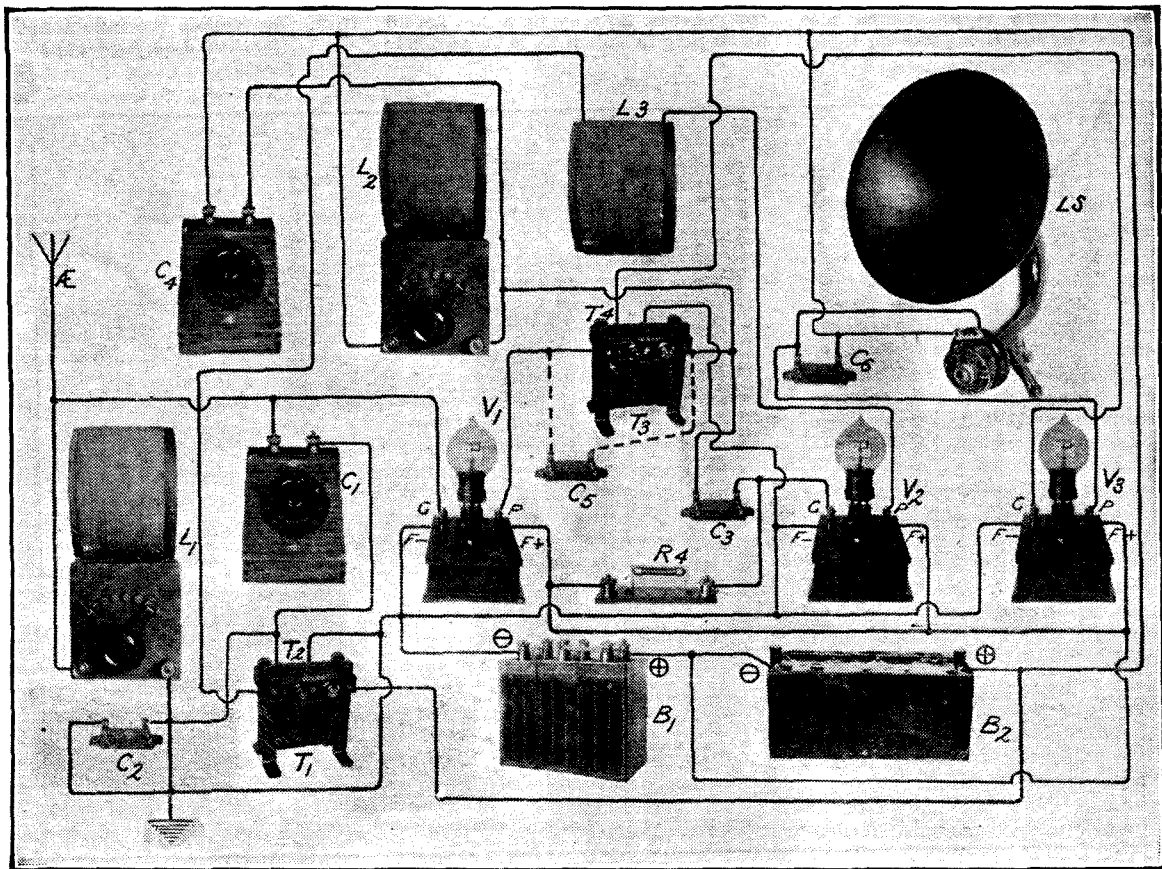

Fig. 10.—How to connect up the circuit of Figure 9.

also exceedingly effective. It has not been used, except to a very small extent, owing to the Post Office ban on reaction applied to the aerial circuit. As this ban has now been raised, the circuit of Fig. 5 may be used, but it is highly unlikely that the experimenter will get any better signals with this arrangement than with the Fig. 1 circuit, which is far less likely to cause trouble to neighbours. On the other hand, the Fig. 5 circuit is an excellent one for many purposes, particularly the reception of continuous waves, whether of short or long wavelength.

It will be seen that the first valve acts as a high-frequency amplifier, the amplified oscillations flowing in the circuit  $L_1, C_2$ . The anode of the first valve is connected to the grid condenser  $C_3$  of 0.0003  $\mu\text{F}$  capacity to the grid of the second valve, which acts as a detector. A gridleak  $R_4$  of about two megohms value is connected across the grid and filament of the second valve. In the anode circuit of this second valve we have the primary  $T_1$  of the step-up intervalve transformer,  $T_1, T_2$ , the primary  $T_1$  being preferably shunted by a condenser  $C_4$  of 0.002  $\mu\text{F}$  capacity. The telephones, or loud-speakers, are connected in the anode circuit of the third valve. Reaction is introduced into both the circuits  $L_1, C_1$  and  $L_2, C_2$  by

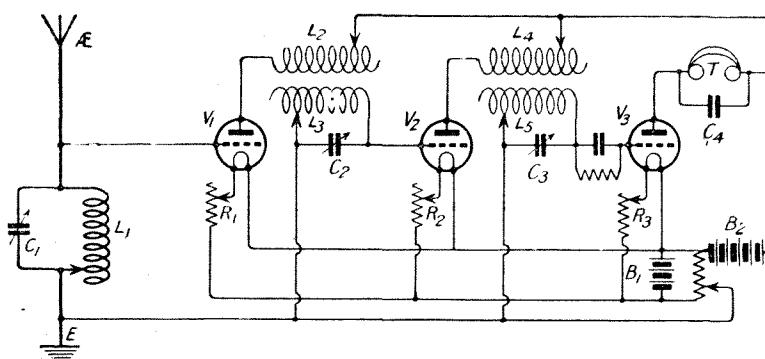

Fig. 11.—Two stages of high-frequency.

coupling the inductance  $L_2$  to  $L_1$ . It is important, of course, to see that the connections to  $L_2$  are the right way round. If desired, the connections from the aerial circuit need not be taken to the negative terminal of the filament accumulator, but may be connected to a slider on a potentiometer connected across the filament accumulator; alternatively, it may be connected to any point on the accumulator  $B_1$ .

Fig. 6 is a photographic representation of the circuit.

As regards the values of the different components,  $L_1$  may be a No. 25, 35 or 50 plug-in coil if  $C_1$  is in parallel;

if  $C_1$  is in series with the inductance, a No. 50 coil or No. 75 coil will usually be found suitable. If a tapped inductance is desired,  $L_1$  may consist of 50 turns of No. 26 gauge double cotton covered wire wound on a 3½ in. tube. Tappings are taken at the 10th, 15th, 20th, 25th, 30th, 35th, 40th, and 50th turns. If the variable condenser is to be connected in series with this coil, the coil may consist of 100 turns of No. 26 gauge double cotton covered wire wound on a 3 in. tube, tappings being taken at the 30th, 45th, 60th, 75th and 100th turn. As regards the inductance  $L_2$ ,  
(Continued on page 154.)

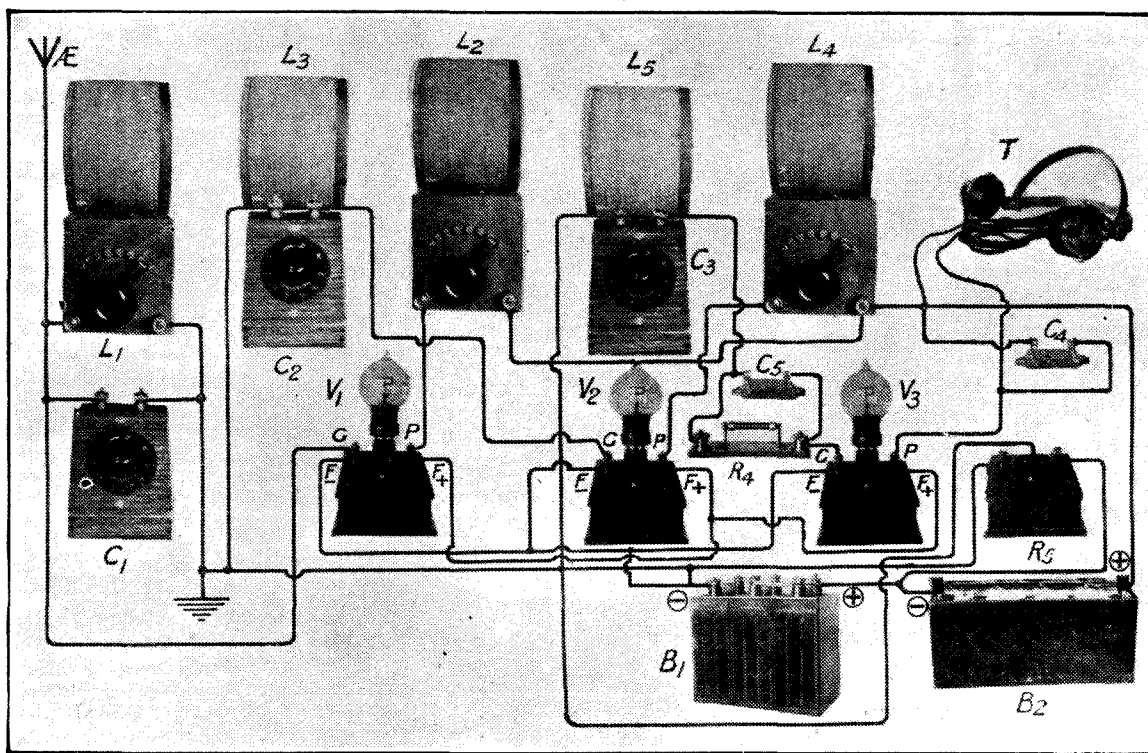

Fig. 12.—The Figure 11 circuit shown pictorially.  $L_4$  and  $L_5$  should be kept well away from  $L_2$  and  $L_3$ , which in turn should be separated from  $L_1$ .



# AN EXPERIMENTAL CRYSTAL SET

A description of the application of untuned aerials to crystal reception

By E. H. CHAPMAN, M.A., D.Sc. (Staff Editor).

**I**N a recent issue of *Wireless Weekly* (Vol. 2, No. 10, September 19, 1923), Mr. Percy W. Harris described a new type of crystal receiver in which the aerial circuit was untuned and was very tightly coupled to the secondary circuit. On another page, under the heading *Random Technicalities*, Mr. Harris recommended experimenters who are looking for something new to investigate the possibilities of untuned aerial circuits.

No sooner had I read the two articles referred to than I decided to carry out a few experiments with untuned aerial circuits, employing spider-web coils instead of cylindrical coils. Before I commenced my experimental work, however, I began to wonder why I had never thought of using an untuned aerial circuit in a crystal set. I have a fair degree of admiration for the Reinartz tuner, which employs an untuned aerial circuit and which is still very popular in America. The Reinartz tuner a long time ago suggested to me a crystal set with an untuned aerial circuit, but I read somewhere in an English or perhaps an American magazine that the principle of the Reinartz tuner could not be applied to crystal reception. I believed what I read, and so I have had to wait until the appearance of the notes referred to to prove to myself that it is not always wise to believe everything one reads in some wireless periodicals, but that it is a good deal better to carry out a few experiments.

The crystal set which I have made with very much the same features as that described by Mr. Harris, is not put forward with the idea of adding one more to the large number of excellent crystal receiving sets already described in *Wireless Weekly* and *MODERN WIRELESS*. It is put forward rather as the basis for a series of interesting experiments which may be carried out at small cost.

### The Spider-Web Coil

There will be no need to give a description of more than one of the coils made by the present writer. Many interesting variations of the coil described will immediately suggest themselves.

The coil, or more strictly the two coils, was wound on a circular cardboard former of 6 in. diameter having nine radial slits. Two kinds of wire were used, No. 22 enamelled for the aerial circuit, and No. 28 D.C.C. for the secondary circuit. Commencing at the inside of the card, 40 turns of the 28 D.C.C. were wound on the card in the usual way. Then the 22 enamelled wire was wound on along with the 28 D.C.C. for the next 10 turns, so that, in that particular section of the coil, there were 10

turns of the enamelled wire alternating with 10 turns of the cotton-covered wire. Finally the 28 D.C.C. wire was continued alone for another 20 turns. It is scarcely necessary to say that on one side of the cardboard disc there would be seen, starting from the inside, first 20 turns of the D.C.C. wire, then five turns of enamelled wire alternating with five turns of the D.C.C. wire, and lastly 10 turns of the D.C.C. wire (Fig. 1).

### The Crystal Detector

The crystal detector (Fig. 2) was constructed from a strip of ebonite, a terminal, a strip of brass and two crystal cups. A double crystal combination was used, zincite-molybdenite. This combination has proved most effective in a number of crystal sets

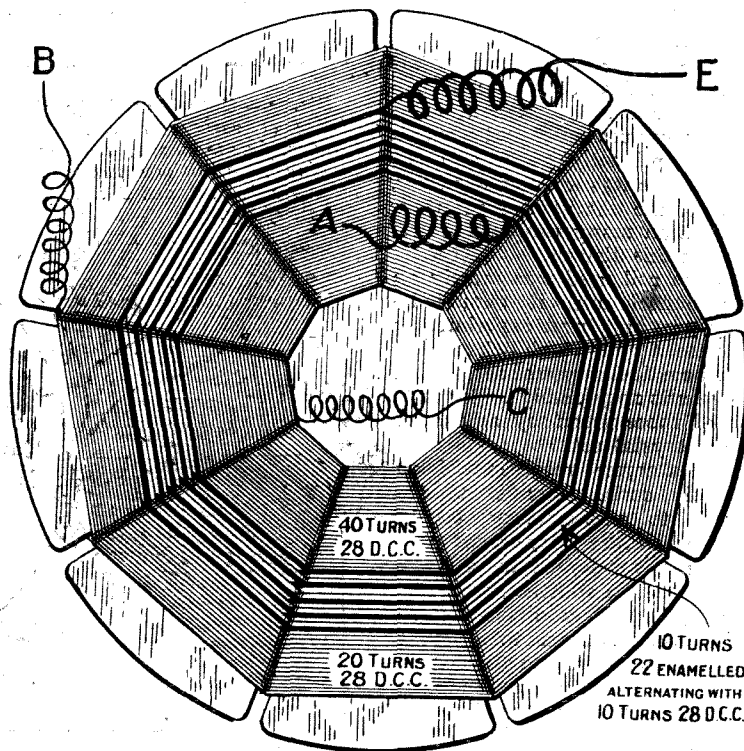

Fig. 1.—AE, untuned aerial circuit; BC, tuned secondary circuit.

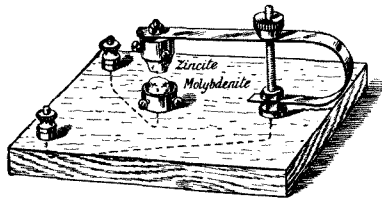

Fig. 2.—The crystal detector.

constructed by the writer. It is important, when purchasing molybdenite, to see that the substance is fairly hard. A soft type of molybdenite which splits into thin layers is of no use as a wireless crystal.

**Results**

In order that various types of flat spider-web coils could be tried easily, the set was assembled on an experimental panel (Fig. 3). The variable condenser used had a maximum value of .0003 mfd.

At a distance of 14 miles from 2LO, the broadcast programmes of this station came in with exceptional clearness, the coil being the one described in this article. Testing the set against other crystal sets of more familiar types, it was found that the new set gave results quite the equal of any other crystal set.

One interesting experiment carried out by the writer was to add a 2-valve note magnifier to the crystal set. This was done for one of the Sunday afternoon broadcast concerts. A small loud-speaker was used. Signal strength was exceptionally good, and the organ music was wonderfully clear. In fact, the set gave results far better than many three-valve sets heard in this district.

As the coil used was merely an experimental one, it should be easily possible for an experimenter to devise a coil, which, when used in this particular type of set, should give results appreciably better than any of those given by any other type of crystal set.

Since a crystal receiver with an untuned aerial circuit tightly coupled to a secondary circuit possesses all the advantages of a crystal receiver embodying a loose-coupler, and, in addition, possesses the simplicity of a direct-coupled receiver, there is bound to be a great future for this new type of receiver.

I shall certainly continue my experiments with untuned aerial circuits in the hope of building a crystal set far better than any I have yet built.

NOTES ON  
HIGH-FREQUENCY  
AMPLIFICATION

In the tuned anode method there are several modifications. We can use, quite efficiently for many purposes, a coil which is tapped at a number of points without any variable condenser for

fine tuning. At each of the tapping points there will be efficient amplification on a small wave-length band, and there are a number of coils on the market suitably tapped so that we can obtain a fair degree of high-frequency amplification simply by changing from one stud to another. If, however, we wish to get the maximum degree of amplification in the tuned anode method we must accurately tune the anode coil to the wave-length we wish to receive. This can be done with a variable condenser connected across the anode coil.

When we come to the second, or transformer, method we again can use either semi-tuned or accurately tuned stages. As before, the highest degree of amplification is obtained with tuned stages. There is some difference of opinion among experts as to whether the tuned anode or the tuned transformer method is the better, but in any case directly we use two tuned stages of high-frequency amplification (whether tuned anodes or tuned transformers) we come up against a very considerable problem. The trouble is the tendency of the whole set to oscillate of its own accord.

There are several reasons for this tendency to self-oscillation. The chief is, if we have two circuits accurately tuned to the same wave-length, the slightest coupling between these two circuits will give sufficient reaction effect to maintain the set in oscillation.

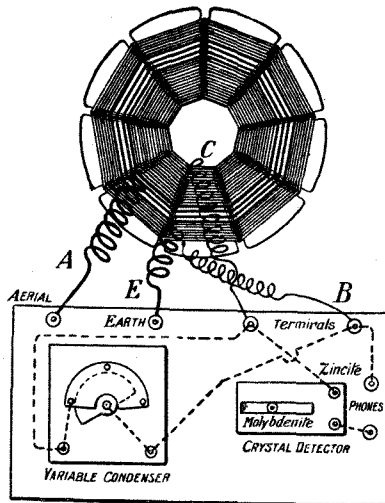

Fig. 3.—Experimental panel consisting of variable condenser, crystal detector, four terminals, and two phone terminals. A coil is shown in position, the letters A, E, B and C corresponding to those of Fig. 1.

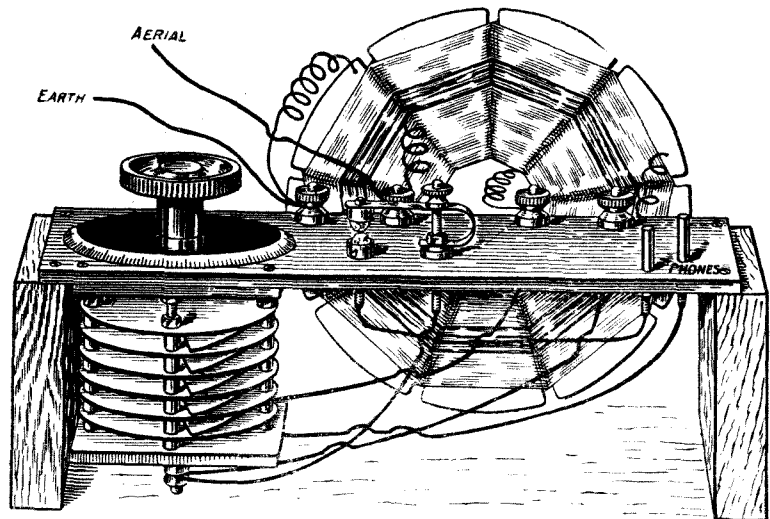

Fig. 4.—The complete assembly in perspective.

## WIRELESS IN SWITZERLAND

Impressions of a British Amateur Abroad.

By H. E. ADSHEAD.

**I**N case this article should fall into the hands of any Swiss reader, let me at the outset disclaim any wide knowledge of the state of Radio there. Having just returned from Zürich, and as no one else has come forward with anything better, I give the results of my observations for what they are worth.

Wireless magazines are non-existent, in either German or French.\* (I might mention that there are two languages in the country.) German is spoken in the East, French in the West, the division being about at Neuchatel. A Swiss dialect which is self acquired may be spoken at home, but school education is conducted in good German. All I managed to discover was No. 2 of a lean journal of 16 pages, costing 60 centimes—6d.—(think of that, ye well-fed MODERN WIRELESS browsers!) issued by the Radio Club Suisse, of St. Imier. (St. I. is N. of Neuchatel.) This by the way contained particulars of a remarkable circuit. Take an ordinary 2-valve L.F. regenerative direct coupled circuit, remove the grid leak and condenser, telephone condenser and L.F. transformer and join the two grids together and there you are with a super-super-Armstrong (?). I haven't tried it yet. The advertisements showed there were Radio firms in Geneva, Lausanne and Bern.

In Zürich I found a firm, Pleyer, recently started, having complete sets and a few components. For a charge of 1s. 6d. you could listen-in at small desks round the walls connected to some central distributor, as one finds abroad in gramophone stores. I did not hear any broadcasting as the times were inconvenient for me. Naturally distances being great, only multi-valve sets were being shown. They had identified the English stations, but were disappointed, as the broadcasting programmes were, of course, out of date by the

time the papers reached Zürich. This is a point the B.B.C. and exporters might consider. Amateur transmission is not permitted; ships are a long way off, so there is not much to tune in on; still they are thus spared the Swiss equivalent of "Old Man" ad nauseam.

I saw some very fine condensers of German make with vanes turned from the solid block—in a zinc-aluminium alloy. The clearances were the thickness of a sheet of paper, and a .001 would go inside a breakfast cup. Supplies were very scarce, as the manufacturers sent them all to the golden U.S.A. If there had been any .0003's I should have done a bit of smuggling. There was a Lorenz 4-valve resistance-capacity amplifier with a reducing plug for English wave-lengths. The valves were only about half the size of the old R.E. 16 and take about  $\frac{1}{4}$  amp. The socket pins are not our standard. The Swiss price was about £1 each valve. Amplifier £15. Asked if they did any trade with England, they said they had written to three addresses but had not been answered! I enquired for the names of the firms but they couldn't recollect them at the moment. Good old Britain—I expect they forgot to write in English!

Just before I left England there had been a preliminary announcement of the new French Gaumont loud-speaker. I enquired after this, but it was not known. I heard, however, that Lorenz, of Berlin, had one coming out in a few weeks, the product of much research and absolutely distortionless. No details were available. I was told Lorenz telephones were very fine, but they were very heavy and, I understood, contained no peculiar design. As there are practically no German amateurs, it appears to me that any German short-wave receivers must be specially made for export, and one wonders if they will be equally efficient on our wave-lengths.

\* This is no longer the case.—Ed.



# Above & below the Broadcast Wavelengths

## Long Wave Interference

IT is a great pity that the only long wave telephone transmission generally available should suffer so much from outside interference. The two chief stations with a wave-length over 1,500 metres are Radiola and the Eiffel Tower. The former works on 1,780 metres and is to be heard every day during the morning, afternoon, and the evening. It is a very powerful station which, on the writer's set (2 H.F., R, 1 L.F. without reaction) comes in only slightly less strongly than 2LO, though the one is 30 and the other something over 200 miles distant. Interference here is caused generally by harmonics and by some French Admiralty stations. There is also another very persistent interrupter, which the writer has not yet been able to identify, since he has nearly always found it in the midst of some apparently endless transmission. The Eiffel Tower's transmissions suffer very much from the attention of the great Marconi station at Ongar, which is usually engaged in working upon one or more of its several wave-lengths. The ones which cause the trouble are GLA, which transmits to Berne on 2,900 metres and GLB, which uses a wave-length of 3,800 metres for working with Paris. It is not actually GLB that annoys us, but the replies to him from Paris UFT, whose wave-length is 2,300 metres.

## Improving Matters

Annoying as these things are, one can do something to improve matters. If no reaction is used an extra H.F. stage being added to compensate for its absence, C.W. interference becomes more or less innocuous so long as the set is kept off the oscillation point. Spark interference, however, is a difficult

problem, for the tuning is always very flat. The best way is to use a very loose coupling and to sacrifice a little of the telephone signal strength in order to weaken spark signals so much that they become barely audible.

## An Atmospheric Problem

Do other readers find, as the writer does, that atmospherics are very much worse as a rule on these longer waves than they are at round about 400 metres? With the set previously referred to they are at times so bad that the transmission is all but spoilt by their cracklings and frizzlings. Yet if one tunes down to below 1,000 metres they become rapidly less and less bad. It is well-known, of course, that atmospherics do make their presence particularly felt on very long waves, but this is only natural since when we get up to 15,000 or 20,000 metres we are approaching the natural wave-length of atmospherics themselves. Possibly the vilest fusillade of cracklings that the writer meets with occasionally between 1,500 and 3,000 metres may be due to some purely local cause. It would be interesting if all readers would record their experiences.

## Amateur Wave-lengths

The lower wave-lengths round about 180 metres are becoming pretty crowded nowadays with amateur transmissions, so much so, in fact, that a good many prefer to make use of the 400 metre wave-length out of broadcast hours. The list of amateurs who hold transmitting licences seems to have grown very rapidly in recent months. The call signs are now well up in the sixes. These amateur transmissions are always well worth picking up, even if the subject matter of the conversation

is not particularly interesting. One not infrequently comes across a pair who are carrying out tests, and it is always rather intriguing to see whether the observer's comments agree with one's own conclusions as to the merits of some particular alternative circuit or piece of apparatus under test. The writer's station is 30 miles out of London and it sometimes happens that the results pronounced superior by the observer at short range are not so by any means at this distance.

## American Reception

American transmissions seem to be coming in very well this autumn; in fact, one hears reports from most of one's friends that they are having more or less success in picking them up. When they were first picked up a year ago the feat seemed to be one of the greatest wonders of the world of wireless. Then as man after man was successful people began to ask why it was they had never been recorded before. The truth probably is that they had never been listened for to any great extent. Anyone with an efficient set attached to a really good aerial and earth can be fairly sure of picking them up if he does not mind sitting up until the small hours on especially favourable nights. These, by the way, I have always found to be nights when the weather was at its vilest. Deluges of rain and particularly a high blustering wind seem to be the ideal conditions for strong reception. On calm, clear nights signals, if they come at all, are usually very much fainter. Others tell me that their experience has been very similar.

## Are your Valves Efficient?

To those who are interested in picking up long distance trans-



missions above and below the broadcast wave-lengths, it is essential that every valve in the set should be doing its work properly. A new valve of good make can usually be relied upon to perform well, but like everything else valves feel the hand of time and are apt to suffer considerable changes in their characteristics after a long period of hard work. When this happens the constants of the particular circuit of which any "aged" valve forms part are altered, with the result that one may be considerably puzzled by the behaviour of the set. The chief effects produced in the valve by long use are these: the total electronic emission from the filament at a given plate voltage falls off; the filament needs more current—a valve which began life with a filament rating of .5 ampere may easily consume .75 ampere at the end of six months or so—and lastly, the vacuum becomes

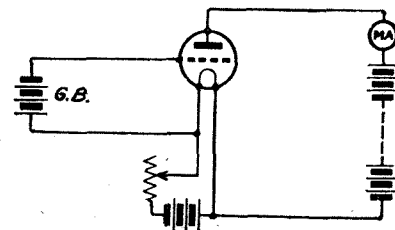

Fig. 1.—Circuit for taking the grid volts plate current curves

less hard owing to the gradual liberation of minute quantities of gas included in plate and grid and in the filament supports, which the process of bombardment during manufacture has not been able to get rid of.

**Softening**

When the emission falls off signal strength declines with it, whether the valve is used as an amplifier or as a rectifier, and a higher voltage on both filament and plate is needed. An old filament becomes so greedy sometimes that it hardly pays to keep the valve in use. Softening renders the valve quite unfit for high-frequency amplifying duty, though it may give surprisingly good results if transferred to the rectifying panel. A valve that has softened badly will pass not less but more current in the plate circuit owing to the ionisation by collision which occurs within it and to the lessening of the space charge by the flow of positive ions

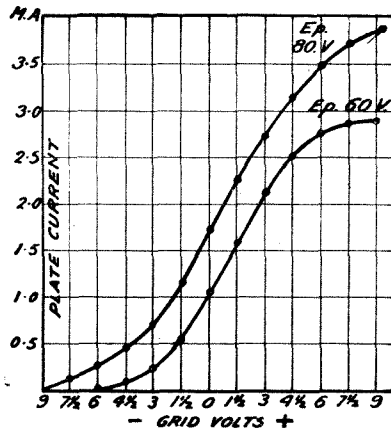

Fig. 2.—The resultant curves.

to the filament. To use a valve which has suffered in this way with the same plate voltage, supplied from the busbar connections, as those in the remaining circuits of the set may spell ruin to the high-tension battery. The writer once found that a very old V24 was passing between 9 and 10 milliamperes, the total plate current for the other four valves in use at the time on the set being only 4.5 milliamperes. This meant that the high-tension battery was being called upon to supply about 15 milliamperes, which is far too great a load for any but those of the largest and heaviest make if they are to last for any time.

**Rough and Ready Tests**

The idea of subjecting a valve to bench tests by taking its characteristic curve is one at which

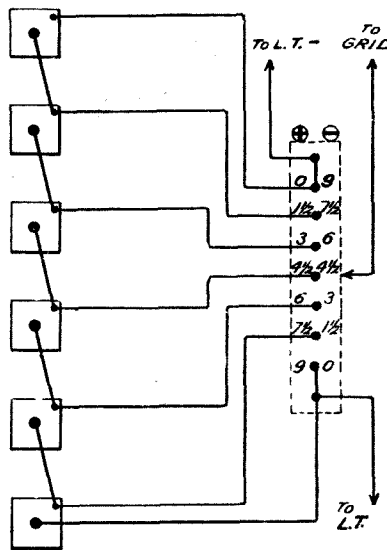

Fig. 3.—A useful testing board.

many amateurs might be inclined to shy. It is quite true that to take exact curves of minute accuracy is a job that only the expert can perform satisfactorily. One can, however, obtain very good rough and ready curves with no great outfit, and the process of taking them calls for no more than ordinary care and accuracy in making readings. The instruments required for the simple tests suggested are such as most amateurs will have; a good voltmeter reading from 0-6 or 0-12 volts, and a milliammeter reading preferably from 0 to about 20 milliamperes. Quite respectable results, however, may be obtained with a milli-

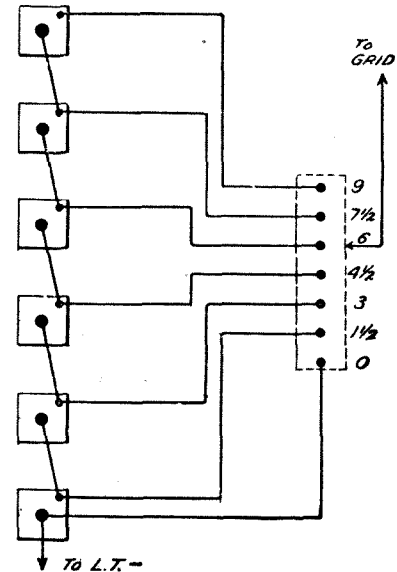

Fig. 4.—A more elaborate board.

ameter reading up to 100, though it is naturally more difficult to make fractional measurements accurately. Beyond this the only requirements are a tapped high-tension battery whose voltage has not fallen off—this may be checked by testing each pair of its sockets with the voltmeter—and half a dozen small dry cells of good make whose E.M.F. is up to the standard 1.5 volts.

**The First Curve**

The circuit for taking the grid volts plate current curve is seen in Fig. 1. The negative end of the filament is first connected direct to the grid without the intervention of the grid battery GB. The reading shown by the milliammeter is taken. A piece of squared paper is ruled out and marked off in the way shown in Fig. 2. On the

vertical middle line corresponding to zero grid volts a dot is made to mark the reading shown by the millimeter, which we will suppose is 1 milliampere.

We now add one dry cell in series between the filament and the grid, its negative pole being connected to the grid and its positive to the negative leg of the valve.

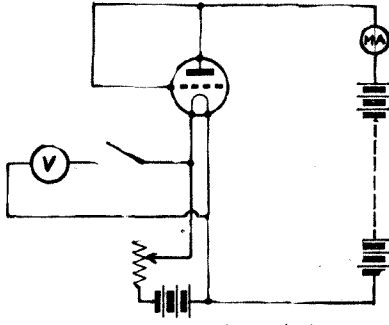

Fig. 5.—The test for emission.

This gives us a grid potential of  $1\frac{1}{2}$  volts negative with respect to the negative end of the filament. We make a dot on the vertical line above the  $1\frac{1}{2}$  volts mark at its intersection with the .5 milliampere line, which we will suppose is the millimeter reading.

**How it is Plotted**

We proceed in the same way to add cell after cell, marking in the readings obtained as each is inserted. At a certain negative voltage the anode current will be so small that we can obtain no readable measurement with the milliammeter. This is the bottom of the curve that will be drawn later. Our next proceeding is to remove all the grid cells and to re-insert them one by one with the previous connections reversed; that is, we now wire the negative terminal to LT—and the positive to the grid. Each added cell thus makes the grid  $1\frac{1}{2}$  volts more positive with respect to the negative leg of the filament. The next set of readings will be marked by dots on the right-hand side of the vertical line. We continue to increase the positive voltage by  $1\frac{1}{2}$  volt steps until the addition of fresh cells produces little or no effect upon the anode current. We have then reached the saturation point, which is the upper limit of the curve.

It will not usually be found that the dots made are so beautifully regular as those shown in Fig. 2. A freehand curve following their

general line and cutting as many as possible of them is drawn, but one or two of them will lie a little way outside it. This may be due to actual "kinks" in the curve, but it is far more likely to be the result of slightly inaccurate readings, or to the fact that the potentials of all the added cells are not precisely the same. In any case the sweeping curve drawn will give a very good idea of the valve's characteristics.

Care must, of course, be taken to keep both plate and filament voltages constant whilst each curve is being made. Having taken the first with, say, 60 volts on the anode we can make others with

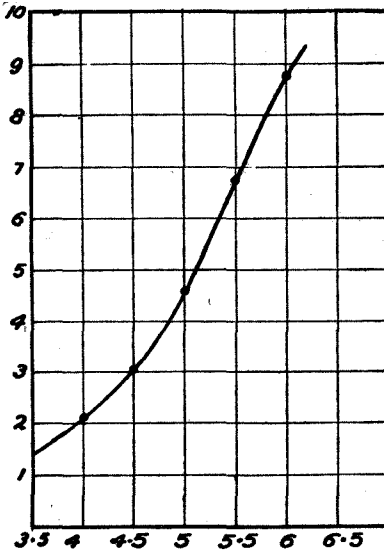

Fig. 6.—The emission curve.

higher and lower voltages in order to see which makes the valve give the best results.

**A Testing Board**

A neat little testing board can be made up as shown in Fig. 3, the cells being connected to a row of seven quick release terminals. For negative readings the positive terminal of the first cell goes direct to negative valve leg, the grid lead being connected in turn to each of the seven terminals, or as many of them as are needed before the point of zero current is reached. To obtain positive E.M.F.'s we reverse the connections. A more elaborate board is shown in Fig. 4. Here nine terminals are used, the top and bottom ones being connected to the grid for positive and negative potentials respectively. On two strips of white cardboard

fixed alongside the terminals the potentials are marked, the positive in red ink, the negative in black.

**The Emission Test**

The test for emission is a very simple one, as the circuit shown in Fig. 5 makes clear. Grid and plate are wired together, the pair being connected to HT via the milliammeter, which thus records the total electronic emission from the filament, and not merely the proportion of it which reaches the plate. Across the filament legs is a voltmeter. The rheostat is adjusted until the filament voltage is, say, 3.5. Then the milliammeter reading is taken and marked in on a piece of graph paper ruled as in Fig. 6. Readings at 4, 4.5, 5, 5.5 and 6 volts will give an emission curve for the particular high-tension voltage in use. Others may be taken for different voltages and plotted on the same sheet.

**Tests for Softening**

There are two tests for softening. The first is to increase the high-tension current gradually and to see whether the valve shows any signs of blue glowing. A valve of normal hardness will show no symptoms of this at any ordinary voltage applied. If, however, it has gone very soft the characteristic blue glimmer which is due, not to the passage of a stream of electrons, but to the flow of positive ions and to ionisation by collision, may manifest itself when the anode voltage is comparatively small. A dead soft valve will blue glow with a high-tension current of 50 volts or less. The best test, however, is to see whether the valve has a large backlash grid current. This can be done quite simply as shown in Fig. 7, the testing board and dry cells being inserted between grid and filament, and a pair of high resistance telephones being placed between the extra cells and the grid. As is well-known, positive grid current begins to flow at a certain negative voltage which depends upon the particular type of valve. The starting point occurs

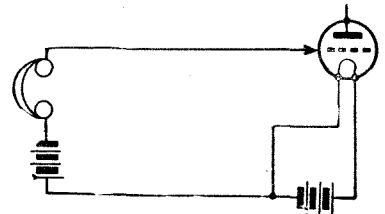

Fig. 7.—Testing for backlash.

usually at a fraction of a volt negative. If the grid is made still more negative what is known as reverse or backlash current is set up, the amount depending upon the softness of the vacuum within the bulb. With a very soft valve reverse grid current is considerable.

In making the test arrange the circuit so that the grid is  $1\frac{1}{2}$  volts positive with respect to the negative leg of the filament. Then touch the grid terminal with the telephone lead. A fairly loud click will occur. Now make the grid potential zero. A much smaller click will be heard. Increase the grid potential to  $1\frac{1}{2}$  volts negative. If serious backlash is present a very loud click will be heard at this point. This is, of course, a test of the most rough and ready kind. To make it better the potentiometer should be placed across two cells and the slider moved gradually so that the potential of the grid is varied from zero to 3 volts negative. In this case the exact point at which there is no grid current can be found, as well as the point at which it reaches its maximum and the point where it ceases to flow.

History Sheets

The best way of seeing that one's valves are up to the mark is to keep a kind of medical history sheet for each of them. Tests on the simple lines indicated may be made when a new valve is brought into service, and it may be examined from time to time, so that the reason for any falling off in its performances may be duly noted. It should be remembered that a valve which has softened is by no means useless. It will no longer be suitable for the high-frequency side of the set, though it may do moderately well as a note magnifier with a low plate voltage. Its best position, however, is upon the rectifying unit. Here it may produce remarkably good results. On the single valve set a soft rectifier is sometimes quite 50 per cent. better than a similar valve in hard condition. Valves which are found to have softened should have a large R painted on them in white and should be reserved for rectifying duty.

LAMBDA.

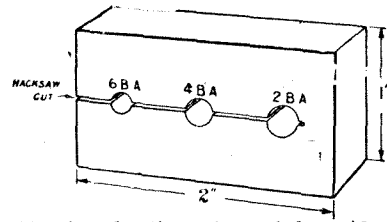

Showing the dimensions of the guide.

A GUIDE FOR SHORTENING SCREWS.

EVERYONE who makes up wireless apparatus knows what a fiddling job it is to shorten small B.A. screws. Yet it is one that has frequently to be done. If one's panels are of  $\frac{1}{4}$ -in. ebonite it is extremely difficult to drill and tap satisfactorily holes that do not go right through from side to side.

Suppose that one has to mount on the underside of a panel a low-frequency transformer. One wishes the ends of the screws to lie exactly flush with the surface of the panel. To hold the screws in the vice without damaging their heads is not easy and it is extremely difficult to cut four all to exactly the same length.

Here is a simple little device which makes matters perfectly plain sailing. Obtain a piece of medium steel  $\frac{1}{4}$ -in. thick measuring 2 in. by 1 in. Soften it a little by heating it and allowing it to cool slowly. Then drill and tap 2, 4 and 6 B.A. holes or any other sizes that are commonly used as shown in the drawing. Make a hacksaw cut from one edge through the middles of the holes drilled, and then reharden the block by heating and plunging into water.

If it is desired to trim a screw it is inserted to the required depth into the appropriate hole. As the holder is of the same thickness as the panel the portion of the shank of the screw which protrudes is superfluous. Fix the holder in the jaws of a vice and trim off the screw with hacksaw and file.

This little holder will be found just as useful for trimming screws to be inserted into thicker panels in holes that do not go right through. For  $\frac{3}{8}$  in. ebonite, for example, its  $\frac{1}{4}$  in. depth will be found exactly right.

R. W. H.

SPIRAL CONNECTIONS FOR PARTIALLY ROTATING SHAFTS

AN easy method of making these hair-spring connectors for condensers, etc. (in the event of not being able to purchase them), is to turn a hardwood or brass conical former as in Fig. 1, and drill a hole in the small end as shown.

The wire—drawn bronze or copper, which should not be too hard, i.e., springy—is pushed in the former hole flush with the other side, and wound up the cone about six turns or so.

The winding may be done in a lathe, coil-winder, or by hand.

When the coil is released and the wire cut, it will probably assume the shape of an awkward cone; care should be taken to make the former small enough, because springy wire grows quite a lot when suddenly released after being wound up on a mandrel.

When the spiral is wound and cut off, the centre may be pulled in with a small pair of pliers until it is flat. It is then ready for use, and all one needs to do is to solder the centre to the movable shaft, and the free end to a terminal, lug, etc.

E. L. B.

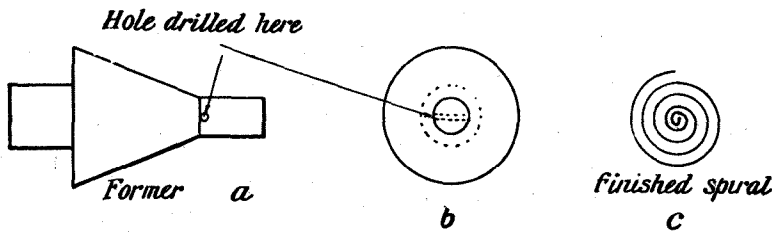

Fig. 1.—Details of how to make the spiral connections.

# THE ST 150 CIRCUIT

By JOHN SCOTT-TAGGART, F.Inst.P., Editor.

*This article deals with a circuit which involves dual amplification, and which gives very effective results.*

**T**HE Postmaster-General has now permitted the application of reaction on to the aerial circuit, both in the case of bought sets and home-made receivers. This raising of the ban does not imply that anything but the greatest care must be used in adjusting the reaction so as not to cause self-oscillation of the set. On the other hand, a very large number of additional circuits may be tried by the experimenter. A circuit which will undoubtedly interest many of those who are anxious to obtain the maximum results with the minimum of valves is the ST150, recently described in *Wireless Weekly*

The circuit is essentially useful when a loud-speaker is to be used. The results obtainable with the circuit are not as good as those obtained with the ST100, but, on the other hand, no crystal detector is used, the second valve acting as a detector.

The circuit is shown in Fig. 1. It will be seen that the first valve acts as a high-frequency amplifier, the oscillating potentials applied to the grid causing amplified oscillations to flow in the circuit  $L_2C_3$ , which is, of course, tuned to the incoming wave-length. The loud-speaker LS is included in the anode circuit of the first valve next to the anode, and it will usually be shunted by a condenser  $C_4$  of about  $0.002 \mu\text{F}$  capacity. It is a matter of experiment to find out whether this condenser  $C_4$  is needed or not. This will depend largely upon the nature of the loud-speaker employed, and it is impossible to state definitely whether the circuit works best with this condenser in or not; the individual must experiment for himself with his own materials. The grid of the second valve is connected through the grid condenser  $C_5$ , having a capacity of  $0.0003 \mu\text{F}$ , to the bottom end of the circuit  $L_2C_3$ , a gridleak  $R_3$ , which is preferably variable, or

(if fixed) of 2 megohms resistance, being connected across the grid of the second valve and the positive terminal of the filament accumulator  $B_1$ .

The anode circuit of the second valve contains the primary  $T_1$  of the step-up intervalve transformer  $T_1T_2$ . A common high-tension battery  $B_2$  feeds the two anode circuits, and an additional refine-

end of the circuit  $L_2C_3$ , being connected to the positive terminal of the high-tension battery  $B_2$ , is, in effect, connected to the filament of the second valve because the high tension battery  $B_2$ , having no appreciable resistance or inductance, acts in no different a manner than an ordinary wire connection, in so far as the high-frequency currents are concerned. The posi-

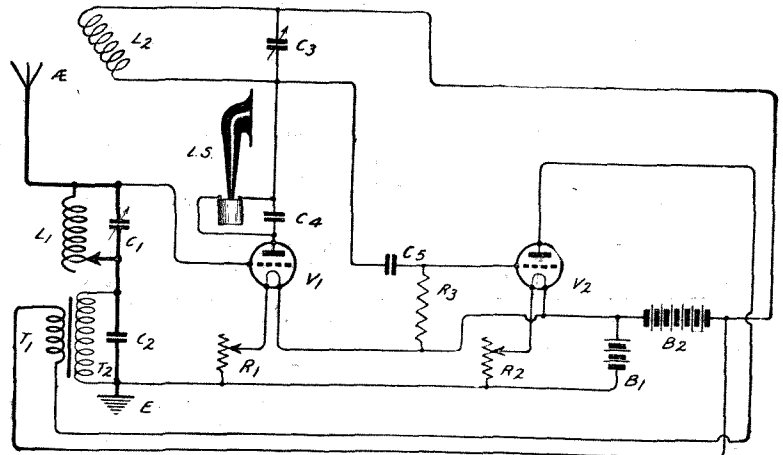

Fig. 1.—The ST150 circuit.

ment, which may be applied to any valve circuit, consists in shunting the high-tension battery  $B_2$  by a fixed condenser of  $1 \mu\text{F}$  capacity.

The operation of the circuit is briefly as follows: The aerial circuit consists of the aerial, the inductance  $L_1$ , shunted by the variable condenser  $C_1$ , the fixed condenser  $C_2$ , which has a capacity of  $0.001 \mu\text{F}$ , and the earth. The oscillating potentials across the aerial and earth are communicated to the grid of the first valve  $V_1$ ; the amplified oscillations pass through  $C_4$  and energise the tuned anode circuit  $L_2C_3$ ; the high-frequency potentials across this circuit are communicated to the grid of the second valve. It is, of course, appreciated that the top

and negative potentials applied to the grid of the second valve cause a rectification effect owing to the positive half-cycles drawing up electrons from the filament, these electrons charging the grid and the right-hand side of the condenser  $C_5$  and making it periodically negative. The audio-frequency variations of grid potentials of the second valve in a negative direction cause varying and amplified audio-frequency current variations in the anode circuit of the second valve, these passing through the primary  $T_1$  of the step-up intervalve transformer  $T_1T_2$ . The currents in  $T_1$  have their voltage stepped-up by the transformer, and the secondary  $T_2$  consequently applies magnified low-frequency potential variations

to the grid of the first valve, these potential variations being communicated through the inductance  $L_1$ . The variations of grid potential produce low-frequency current variations through the loud-speaker LS, which is thereby operated by them.

It will thus be seen that the grid of the valve  $V_1$  is having its voltage varied comparatively slowly by low-frequency currents and also at very much higher frequencies by the incoming oscillations. These two effects take place simultaneously, but do not interfere with each other. In the anode circuit of the first valve the low-frequency currents flow through the loud-speaker LS and operate it, while the high-frequency currents go through the by-path condenser  $C_1$ , or if this condenser is missing, pass through the natural condenser provided by the self-capacity of the loud-speaker windings. The low-frequency currents, of course, do not pass through the condenser  $C_1$ , because its capacity is small relative to the frequency of the audio-frequency currents.

It might at first be wondered why the loud-speaker is connected to the anode of the first valve instead of in the lead between the top of the circuit  $L_2C_3$  and the positive terminal of the high-tension battery. The reason for this is that we desire to avoid a chain of low-frequency reaction. If the loud-speaker were included in the other position instead of the one shown, the low-frequency potential variations across the terminals of the loud-speaker, due to the varying currents flowing through the windings, would be communicated through the condenser  $C_3$  to a certain extent in spite of the small dimensions of this condenser, to the grid of the second valve, where they would be once more amplified. These amplified currents would be taken back to the grid of the first valve, where they would be amplified once more and a chain of reaction would be introduced which would tend to make the circuit unstable and probably to howl at an audible frequency. If, however, the loud-speaker is connected in the position shown, any low-frequency potential variations across the terminals of the loud-speaker cannot be communicated to the grid of the second valve, and therefore the chain of low-frequency reaction is broken.

The inductance  $L_2$  may be kept

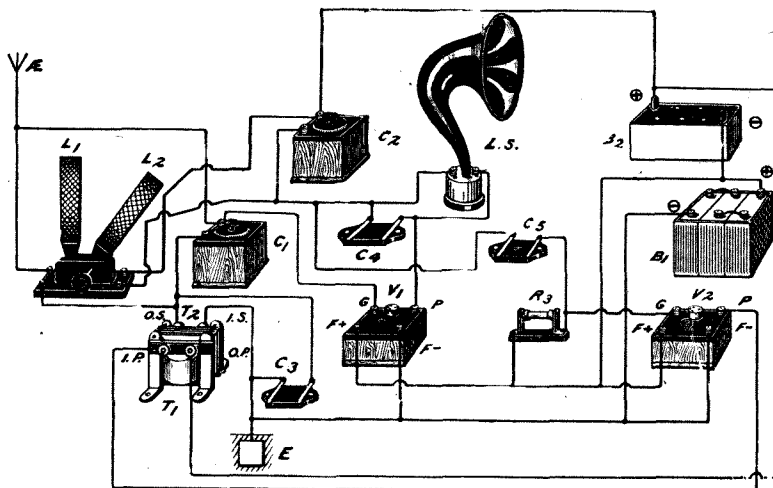

Fig. 2.—The circuit shown pictorially.

away from  $L_1$ , but a decided increase in signal strength is obtainable by coupling  $L_2$  to  $L_1$  in such a way as to introduce reaction into the aerial circuit. Losses in the aerial circuit may therefore be compensated for to a considerable extent, and not only is the signal strength increased, but the selectivity of the aerial circuit is increased. Moreover, as the reaction is not confined to the aerial circuit, it will be found that when reaction is being employed it will be necessary to tune the condenser  $C_3$  more carefully.

With regard to the values of the different components in this circuit, the following particulars which apply to the range of wave-lengths from about 300 to 650 metres will be of interest.

The inductance  $L_1$  may consist

of a 3½ in. diameter tube wound with No. 26 gauge double cotton covered wire; 50 turns are employed, and tappings are taken at the 10th, 15th, 20th, 25th, 30th, 35th, 40th and 50th turns. If a honeycomb coil is used, the size of this will depend upon the aerial employed. Most of the coil manufacturers are now supplying special concert coils which have from 25 to about 50 turns. As regards the inductance coil  $L_2$ , the size of this may be 70 turns of No. 26 gauge double cotton covered wire wound on a 3 in. tube which may slide inside the other tube  $L_1$ . Tappings may be taken at the 30th, 50th and 70th turns. If a plug-in type of coil is used for  $L_2$ , a No. 50 or No. 75 coil will be found the right size.

The condensers  $C_1$  and  $C_3$  should have a maximum value of about

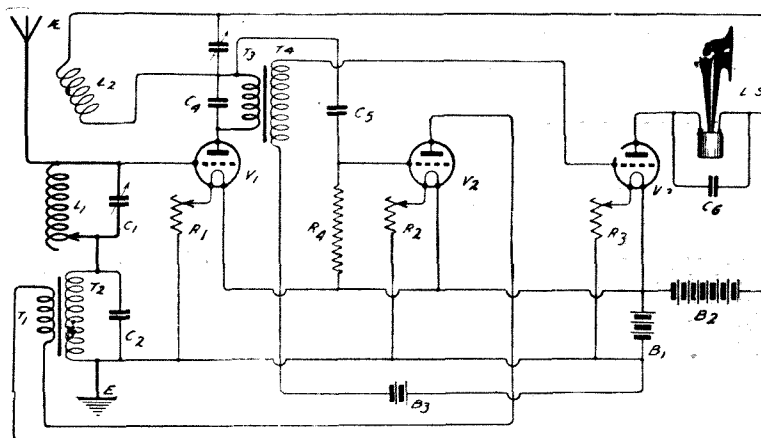

Fig. 3.—How an additional stage of note magnification can be added.



0.0005  $\mu$ F, and  $C_2$ , if desired, may also be a variable condenser of 0.001  $\mu$ F capacity. If this condenser is variable a fine adjustment of reaction is obtainable, but there is no reason why the condenser  $C_2$  should not be fixed, in which case a value of 0.001  $\mu$ F is recommended. The high-tension voltage, of course, is more a matter of choice than anything else; personally I always use a 100-volt high-tension battery when using a loud-speaker. The circuit, however, will work quite well on very much lower H.T. voltages.

When operating the circuit, the reaction coil  $L_2$  should be kept, at first, well away from  $L_1$ , and the condensers  $C_1$  and  $C_3$  carefully adjusted. Then bring the coil  $L_2$  closer to  $L_1$ , carefully readjusting the condensers  $C_1$  and  $C_3$  every time the coil is brought a little closer to  $L_1$ . It is important to see that the leads to the reaction coil are the right way round, as otherwise reverse reaction will be obtained, and although a form of capacity reaction is obtainable in these cases, as I recently explained in *Wireless Weekly*, this is most undesirable. As the reaction coil is brought closer to  $L_1$ , it should be necessary to reduce the values of the condensers  $C_1$  and  $C_3$ . If it is necessary to increase the values of these condensers as the coil  $L_2$  is brought closer to  $L_1$ , it is a clear indication that the leads to the reaction coil are the wrong way round.

**Arrangements of Components**

Fig. 2 shows the same circuit arranged in component form for the benefit of those who may prefer this method of illustrating a circuit.

**The ST151 Circuit**

The principal disadvantage of the ST150 circuit is that when telephone receivers are connected across the condenser  $C_4$ , the varying capacity to earth of the telephone receivers will slightly vary the tuning of the circuit  $L_2C_3$ , because the phones to earth capacity is really in parallel with the condenser  $C_3$ . When reaction is adjusted to the best point, the slight variations in the capacity across  $L_2$  will cause a change in the signal strength and may cause the first valve to oscillate.

This undesirable effect may most easily be eliminated by using three valves instead of two, the third valve acting as a low-frequency amplifier. The three-valve circuit is illustrated in Fig. 3, which is numbered Circuit ST151 in my new book of valve circuits entitled "More Practical Valve Circuits." \*

In this circuit it will be seen that, instead of connecting a loud-speaker in the anode circuit of the first valve, we have the primary  $T_3$  of the step-up intervalve transformer  $T_3T_4$ , the primary  $T_3$  is shunted by a condenser  $C_4$  of about 0.002  $\mu$ F capacity, although the advisability of having a condenser in this position is a matter for experiment.

**A Circuit for Use with Phones**

Although the ST 150 lends itself to the use of telephone receivers, yet those who find trouble when the fullest amount of reaction is used may care to try the circuit illustrated in Fig. 4. This involves the same principle as that described in the writer's British Association paper of this year. The inductance  $L_2$  now has wound over two identical inductances  $L_3$  and  $L_4$ ; there are therefore three layers of inductances, each identical with the others. The telephones T are connected across the ends of  $L_3$  and  $L_4$ , and a fixed condenser of 0.002  $\mu$ F may be connected across

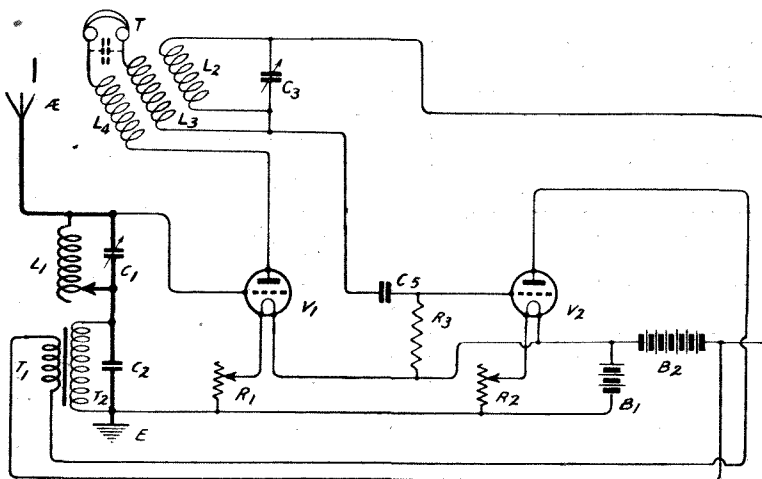

[ Fig. 4.—A special modification for use with telephones.

The circuit operates in exactly the same way as the preceding one, except that there is an additional stage of low-frequency amplification. The first valve acts as high-frequency amplifier, the second as a detector, the first as a low-frequency amplifier, and the third as a second low-frequency amplifier. The different values of the components are the same as those employed in the preceding circuit. The condenser  $C_6$  across the loud-speaker LS may have a value of from 0.002  $\mu$ F upwards. The effect of this condenser is to mellow the tones of the signals, but if the condenser is too large the tone becomes muffled and considerably weaker.

the telephones T. Like so many other things in valve circuits, it is a matter for experiment as to the need, or otherwise, of this condenser across the telephones. By the use of this triple winding the telephones are brought to earth potential and may be touched without fear of interfering in any way with the operation of the circuit. This, of course, cannot be said of the original ST150. If telephones are used in this circuit their insulation should be perfect, and the terminals on the telephones, if exposed, should not be touched, as otherwise the signals will be weakened.

We will be interested to hear from any readers of the results which they have received with any of these circuits.

\* Published by Radio Press, Ltd., at 3/6 (cloth edition only).

## A FREE GIFT TO READERS

*Almost everyone dislikes the idea of missing something which he might easily have had by a slight effort. This is particularly true of wireless enthusiasts, whether the "something" is a special transmission, long-distance results, or a new circuit.*

**V**ERY few readers of MODERN WIRELESS, especially those who have constructed and experimented with their own apparatus, will have arrived at the stage when further advance does not seem possible.

In the very early days of wireless there was keen competition between the advocates of thick wire and the advocates of thin wire for winding tuning coils for use with crystal detectors, the only means of detection then available. With the introduction of the valve, multi-valve receiving sets became all the fashion, and efforts appear to have been made to see how many valves could be incorporated in a set, the present writer knowing of at least one set which included 18 valves.

A more recent development has been in the direction of improved use of reaction and super-regeneration, whilst the latest tendency is to endeavour to make each individual valve function in more than one capacity, as, for instance, in the dual circuits.

To the up-to-date home constructor and experimenter, therefore, the prime consideration is circuit design, and in no technical wireless journal are his requirements more fully met than in our contemporary journal, *Wireless Weekly*.

So rapidly do important developments take place that only regular readers of a live weekly journal can keep themselves properly up-to-date. Consider the following list of descriptive and constructional articles which have appeared in *Wireless Weekly* during the last few weeks:

**THE COWPER CIRCUIT.**—An entirely new method of high-frequency amplification especially suitable for short-wave reception, and particularly stable in operation.

**A NEW SINGLE-VALVE CIRCUIT.**—Constructional details of a receiver which may be used without an aerial of any kind.

**THE AUTOPEX CIRCUIT.**—A greatly simplified form of super-regenerative single-valve receiver.

**A SINGLE-VALVE REGENERATIVE REFLEX RECEIVER.**—The set which gained the first prize in a recent American competition.

**THE RESONANCE WAVE COIL ELIMINATOR.**—Explaining a practical method of eliminating interference due to atmospherics.

**TUNING INDUCTANCES OF HIGH EFFICIENCY.**—Constructional details of a new type of inductance coil.

**CHARACTERISTIC CURVES** and the results of actual tests made with all the new dull-emitter valves.

**A CRYSTAL RECEIVER AS A WAVEMETER—ALL STATIONS ON A FRAME AERIAL—A THREE-VALVE**

**RECEIVER FOR ALL WAVE-LENGTHS—A VARIOMETER CRYSTAL UNIT—SOME DEVELOPMENTS IN SHORT-WAVE RESEARCH—PRACTICAL SHORT-WAVE TRANSMISSION—Wireless Weekly THREE-VALVE RECEIVER.**

**SOME MODERN RECEIVING CIRCUITS.**—A comprehensive collection of American receiving circuits (ten in number), with details for their assembly.

*All of the foregoing have appeared in "Wireless Weekly" during the last seven weeks.* Those readers of MODERN WIRELESS who are not also regular readers of *Wireless Weekly* can form their own opinions as to what interesting and helpful information they have missed, all of which might have been theirs at a cost of sixpence per week.

Although a "quality" production, and certainly value for money, it is the constant endeavour of the staff of *Wireless Weekly* to make it *the best weekly wireless journal*, and with the object of gaining the approval and regular support of *all* readers of MODERN WIRELESS, and as many of their friends as possible, ON DECEMBER 12TH WILL APPEAR THE FIRST OF A SERIES OF SIX SPECIAL ISSUES, which, in addition to the usual regular features, will contain:—

Six special articles on Dual Amplification, by John Scott-Taggart, F.Inst.P.

Six articles dealing exhaustively with the design of receiving sets, by Percy W. Harris.

Six new circuits, by A. D. Cowper, M.Sc. (the inventor of the Cowper Circuit).

The *Wireless Weekly* Universal Valve Panel, by means of which experimenters will be able to try out no less than 20 different circuits.

*Each of the six issues will contain a dated coupon, and on sending these six coupons to Radio Press, Ltd., with remittance, any of their books will be forwarded for HALF THE USUAL PRICE. So that readers who cannot obtain the first issue may not miss the benefits, an additional coupon will be included in the seventh issue. This will be accepted in place of coupon No. 1.*

The house of Radio Press, Ltd., and the staff of *Wireless Weekly* are out to do their very best in these six special issues. Will you, on your part, give them a measure of support? HOW? Firstly, by placing an order for the supply of *Wireless Weekly* for the six weeks commencing December 12th; and, secondly, by recommending *Wireless Weekly* to your friends as being, *par excellence*, the journal for the wireless enthusiast. Incidentally, if you will let us have the name and address of a friend interested in wireless, we will be very pleased to send him, free of charge, a specimen copy.

## FURTHER LONG-WAVE CIRCUITS

By G. P. KENDALL, B.Sc., Staff Editor.

(Note: A previous article on this subject appeared in our October issue.)

### Transformer Coupling.

Figs. 8-11 illustrate various forms of a method of inter-valve coupling whose popularity seems to be waning, although it has certain special advantages which entitle it to be placed among good long-wave circuits. Transformer coupling may be divided for practical purposes into the tuned and the semi-aperiodic types.

"Tuned" transformers are wound with moderately low-resistance wire and have one or both of their windings (usually the primary) tuned exactly to the received wave-length with small variable condensers. This system is slightly less sensitive than the tuned anode type, and also less selective, but it is more stable when used for more than one stage of amplification. As a matter of personal preference I would use it for two stages of H.F. rather than tuned anode coupling, on account of its greater ease of operation. For

using tuned transformer coupling is illustrated in Fig. 9, where the condensers  $C_2$  and  $C_3$  may be of  $0.0003 \mu\text{F}$ , the other components being of the standard values already given. The transformers should be of the plug-in type, and it is recommended that they should be pur-

resonance point is flattened out over a broad band of wave-lengths. They may be purchased, when they usually consist of an ebonite cylinder with the windings contained in a series of grooves, or they can be made quite easily. Turn from half-inch ebonite a disc 3 in.

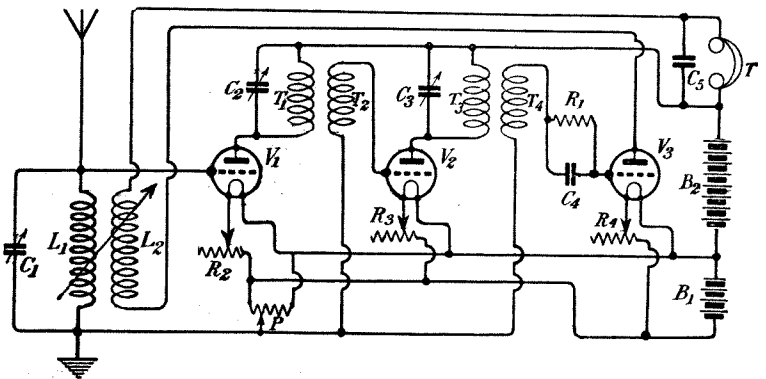

Fig. 9.—A circuit employing two tuned transformers.

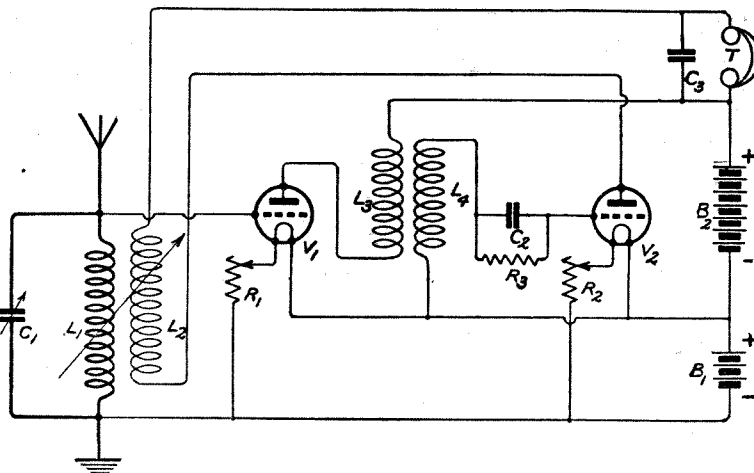

Fig. 8.—A two-valve circuit employing a semi-aperiodic transformer.

more than two stages of amplification it becomes impracticable because of the difficulty of manipulating so many tuned circuits, and recourse must be made to one of the untuned or semi-tuned couplings.

A good 2 HF and detector circuit

chased, since to wind a complete double set for all waves is a rather laborious business, and they are not unduly expensive.

Semi-aperiodic transformers are those whose windings consist of very fine resistance wire, so that their

in diameter, and in its edge turn two grooves  $\frac{3}{16}$  of an inch wide and  $\frac{1}{4}$  of an inch deep, and wind in these grooves primary and secondary windings each having 2,500 turns of No. 44 single silk-covered resistance wire, taking the ends out to four terminals on the centre of the bobbin, or to four valve pins so that it may be interchangeable with the standard plug-in type.

A simple two-valve circuit employing one of these transformers is given in Fig. 8. This circuit will be found very easy to operate and to give results somewhat superior to those of the circuit of Fig. 3; to obtain the best results try reversing the connections of the primary winding  $T_1$ .

A very sensitive circuit coupled in the same way is shown in Fig. 10. A very high degree of amplification is obtainable with this receiver, so that it may be used successfully with a frame aerial. Although it is reasonably stable it will generally oscillate quite readily by manipulation of the potentiometer, if it is

required to receive continuous waves without the aid of a separate oscillator, although this course is not advised. Reaction coils are shown in Figs. 8 and 9, since it is not possible to obtain ease of adjust-

self-oscillation that one can dispense with any special reaction coil.

A separate heterodyne can readily be used with all these circuits, of course, and it may be coupled to their aerial circuit or to whichever

to any of the circuits considered in this article, but its sphere of usefulness in long-wave reception is somewhat limited. Fig. 11 shows how two stages of L.F. may be added to the circuit of Fig. 10, to

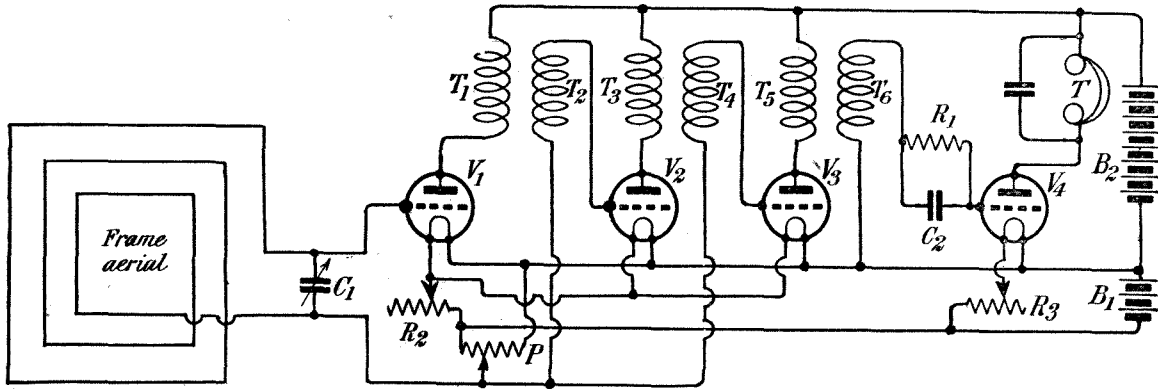

Fig. 10.—A sensitive circuit for frame aerial reception. The transformers are of the strongly damped type.

ment and steady self-oscillation without them, but the use of so many HF valves as are shown in Fig. 10 involves so strong a tendency to

of the inter-valve transformers gives the best results.

Stages of low-frequency amplification can also be added at will

enable it to operate a loud-speaker when required, and the same method of connection would apply to all the other circuits which I have given.

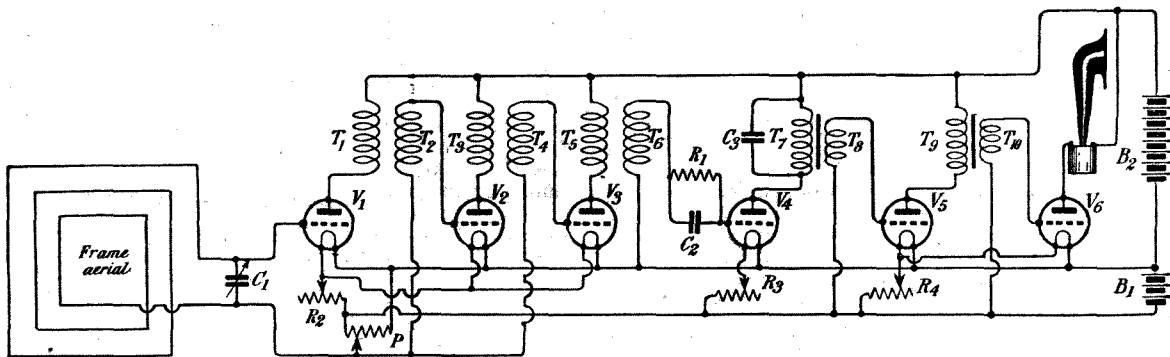

Fig. 11.—The circuit of Fig. 10 with the addition of two low-frequency amplification stages to operate a loud-speaker.

## RECENT ADDITIONS TO OUR LIST OF EXPERIMENTAL CALL-SIGNS

To be appended to our Wireless Directory.

CALL	NAME OF OWNER.	ADDRESS.	CALL	NAME OF OWNER.	ADDRESS.
5 HN	D. R. ETCHELLS ... ..	"Kingsley," Oaken, Nr. Wolverhampton.	5 ZO	W. F. MILLS ... ..	11, Stoney Hey Road, New Brighton, Cheshire.
5 IC	IVOR MORRIS ... ..	The Compton, Cemaes Bay, Anglesey.	5 ZR	F. AUSTEN ... ..	52, Church Street, St. Peter's, Broadstairs.
5 LG	J. F. JOHNSTON ... ..	48, Borough Road, Altrincham, Cheshire.	6 BW	J. C. MASON ... ..	8, Westmoreland Road, New Brighton.
5 RZ	A. G. WOOD ... ..	93, Upper Tulse Hill, S.W. 2.	6 DM	C. KNIGHT-COUTTS ... ..	16, Vine Street, Evesham.
5 SW	C. BEDFORD ... ..	Turton Hall, Gildersome, Nr. Leeds.	6 DW	DOUGLAS H. JOHNSON ... ..	131, Clapton Common, London.
5 TI	J. BONNETT ... ..	159A, Turner's Hill, Cheshunt.	6 FJ	C. V. JARVIS ... ..	21, Baltic Road, Tonbridge.
5 TW	R. S. BAUGH ... ..	"Longfield," Wake Green Road, Moseley, Birmingham.	6 GM	E. A. WILSON ... ..	"Roxburgh," 42, Heber Road, N.W. 2.
5 TX			6 GZ	R. C. NEALE ... ..	Farnborough Road, Farnboro' Church Road, Acton, W. 3.
5 UM	H. AL'CHIN ... ..	78, Chester Road, Forest Gate, E. 7.	6 HD	NATIONAL WIRELESS AND ELECTRIC, LTD.	
			6 IX	W. G. FUDGER ... ..	"Brora," Priviswood Road Godalming.

(Continued from page 140.)

this will usually be either a No. 50 or No. 75 plug-in coil. If a tapped inductance is desired, 70 turns of No. 26 double cotton covered wire wound on a 3 in. tube may be used, tappings being taken at the 30th, 50th and 70th turns.

**A Three-Valve Circuit using a Crystal Detector**

Fig. 7 illustrates what is unquestionably one of the best possible circuits of the "straight" type which the home constructor can use. The first valve acts as a high-frequency amplifier, the anode circuit  $L_2 C_2$  having shunted across it the crystal detector D and the primary  $T_1$  of the step-up intervalve transformer  $T_1 T_2$ . The inductance  $L_2$  is coupled to  $L_1$  in such a manner as to produce a reaction effect, this effect being thereby applied, not only to the aerial circuit, but also to the tuned anode circuit. It is important to see that the connections to the reaction coil  $L_2$  are the right way round, or, alternatively, to see that the coupling between the reaction coil and the aerial coil  $L_1$  is the right way round. The high-frequency oscillations in the tuned anode circuit  $L_2 C_2$  are rectified by the crystal detector, and low-frequency currents are applied to the grid of the second valve which thereupon acts as a low-frequency amplifier, the amplified currents passing through  $T_3$  which is the primary of the step-up intervalve transformer  $T_3 T_4$ . The secondary  $T_4$  is connected across the grid of the third valve and the negative terminal of the filament accumulator. The telephone receivers T are included in the anode circuit of the last valve. Instead of telephone receivers, of course, a loud-speaker might be employed.

This circuit has many excellent features to commend it, and it is particularly suitable for those whose experience of valve circuits is not great. I would advise the beginner to keep the reaction coil  $L_2$  well away from  $L_1$  to begin with. Although it is now permissible to apply reaction on to the aerial circuit yet this should be done with the greatest care so as not to cause radiation from the aerial due to self-oscillation of the first valve. On longer wave-lengths, of course, when not receiving broadcasting, or in fact, on any wave-length outside broadcasting hours, continuous wave stations may be heard by coupling the inductance  $L_2$  closely to  $L_1$  so that the first valve oscillates. It will then be possible to receive continuous wave signals.

Fig. 8 shows how the different parts in Fig. 7 may be arranged and connected up. This idea of connecting the different parts up on a table without mounting them in a cabinet is a very good one, as innumerable circuits may be tried without having to change the apparatus.

The inductance  $L_1$  may consist of 50 turns of No. 26 gauge insulated wire wound on a 3½ in. tube and tapped at the 10th, 15th, 20th, 25th, 30th, 35th, 40th and 50th turns. The inductance  $L_2$  may be 70 turns of No. 26 wound on a 3 in. tube, tapped at the 30th, 50th and 70th turns.  $L_1$  might be a No. 25, 35 or 50 honeycomb coil, while  $L_2$  is a No. 50 or 75.

**The ST76 Circuit**

Leaving the "straight" type of circuit, I would like to describe the ST76 circuit, which is a remarkably efficient arrangement which is really equivalent to a four-valve receiver using tuned anode coupling. The ST75 is the two-valve circuit, while the ST76 involves the addition of an extra stage of low-frequency amplification; at the same time the three-valve circuit is a better one to handle than the two-valve arrangement, except when the latter employs a loud-speaker.

The Fig. 9 circuit involves one stage of high-frequency amplification, the use of the second valve as a detector, the use of the first valve as a low-frequency amplifier and the use of the third valve in a similar capacity. As is usual in most of my dual amplification circuits, the secondary  $T_2$  of the step-up intervalve transformer  $T_1 T_2$  is connected both in the aerial circuit and the grid circuit of the first valve. It was formerly the common practice to include this secondary between the earth terminal and the filament accumulator, with the result that the accumulator, telephones, high-tension battery, etc., were all at a varying low-frequency potential to earth; the result was that howls and squeaks were very common and any natural low-frequency reaction was continually varying. By adopting the idea of connecting the secondary in the aerial circuit, the accumulator, high-tension battery, etc., were all kept at earth potential and touching them produced no ill effects. The circuits are therefore very much more stable.

This improvement was first described by the writer in connection with the ST100 receiver in *Wireless Weekly*.

In the anode circuit of the first valve is the primary  $T_3$  of the step-up intervalve transformer  $T_3 T_4$ . This primary is preferably shunted by a condenser  $C_3$  of about 0.002  $\mu$ F capacity. The secondary  $T_4$  is connected across the grid and filament of the third valve. In the anode circuit of the first valve we also have the tuned anode circuit  $L_2 C_2$  which is tuned to the incoming wave-length. A connection is taken from the bottom end of this circuit to the grid of the second valve through the condenser  $C_5$ , the usual gridleak  $R_1$  being connected across the grid and positive terminal of the filament accumulator. The gridleak is preferably of the variable type, but if fixed should have a value of about 2 megohms. The anode circuit of the

second valve contains the reaction coil  $L_3$ , which is coupled to  $L_2$  in such a way as to introduce reaction into the circuit  $L_2 C_2$ . In the anode circuit of the second valve we also have the primary of the step-up intervalve transformer  $T_1 T_2$ . The loud-speaker, or telephone receivers, will be found in the anode circuit of the third valve, a condenser of medium capacity being connected across it; this may be omitted without any serious disadvantages.

In the operation of this circuit it is important to see that whenever the reaction between  $L_3$  and  $L_2$  is varied the condensers  $C_2$  and  $C_1$  are also readjusted. It is sometimes necessary, in order to stabilise the circuit, to connect a 100,000 ohm resistance, preferably of the variable type, across the grid of the first valve and the positive terminal of the filament accumulator.

Fig. 10 shows a photographic arrangement of the different component parts to build up this circuit. I would not advise the beginner to try this circuit until he has gained experience with more straightforward types, as dual amplification circuits usually need a little more experience to handle them experimentally.

The inductance  $L_1$  may consist of 50 turns of No. 26 wire wound on a 3½ in. tube and tapped at the 10th, 15th, 20th, 25th, 30th, 35th, 40th and 50th turns. The coil  $L_2$  may be a 3 in. tube wound with 70 turns of No. 26 and tapped at the 30th, 50th and 70th turns. The reaction coil may be 35 turns of No. 26 wound on a 3½ in. tube.  $L_1$  might be a No. 25, 35 or 50 honeycomb coil,  $L_2$  a No. 50 or 75, and  $L_3$  a No. 75.

**A Three-Valve Receiver using Two Stages of High-Frequency Amplification**

The circuit shown in Fig. 11 involves two stages of high-frequency amplification. In order to assist in maintaining stability it will be noticed that the earth potential ends of all the grid circuits are connected on to a slider which moves along the potentiometer resistance  $R_3$  which may have any value up to, say, 400 ohms; this latter value is generally that of most potentiometers, but as a potentiometer does not take much current from the filament accumulator, the resistance of the potentiometer is not very material.

It will be seen that the coupling between the valves is effected by means of an air-core transformer in which the secondary is tuned by means of a variable condenser. Both primary and secondary are preferably tapped. The experimenter may also try connecting the variable condenser across the primary of the transformer, i.e., the windings included in the anode circuit of the first and second valves.



## THE TRANSATLANTIC RECEIVER.

### Modifications for Reaction and Long Waves.

By *PERCY W. HARRIS, Assistant Editor.*

IT is a comparatively simple matter to modify the Transatlantic receiver so that magnetic reaction may be obtained directly on to the aerial. On longer waves this is necessary, as it will be found impossible to obtain sufficient reaction by manipulation of the potentiometer and filament resistances. By introducing the modification about to be explained, there is no loss whatever in efficiency on the shorter waves—a most important point.

The only change necessary is to fix a two-coil holder on the top of the box, together with two terminals. These terminals, as will be seen from the photograph, are fitted into polished ebonite bushes to provide proper insulation. The two-coil holder actually used was a Bowyer-Lowe, this being mounted on an ebonite disc

with terminals beneath. To fit this holder it is necessary to cut a circular hole in the top of the box. As it is imperative, if the efficiency of this set is to be preserved, to keep the grid leads short on short-wave adjustment, no alteration of the grid circuit wiring is made. When long waves are used a transfer plug fits into the usual coil socket, and wires from this go up to the two terminals on the top of the cabinet. The only alteration of wiring internally is to the lead which previously went from the plate of the last valve to the telephone terminals. This lead is now taken from the plate terminal to one of the moving coil terminals, the other of which is brought down to the telephone terminal and condenser. The original wiring is shown dotted in the diagram. Two stiff wires are also taken from the terminals of

the fixed coil to the two new terminals on the top of the box. This is also shown in the diagram. The transfer plug may be any ordinary coil socket plug suitably fitted with two flexible leads. The ends of these leads should be finished with brass spade terminals.

For short-wave reception the moving coil socket should be kept short-circuited by a suitable plug, and the aerial tuning coil is inserted into the original socket as previously. For long-wave reception the ordinary coil socket is connected by the transfer plug to the fixed socket of the two-coil holder, and the shortening plug in the moving socket of the holder is removed and in its place a suitable reaction coil inserted. Reaction will now take place from the plate of the last valve on to the aerial direct. Owing to the fact that high-frequency amplification of two

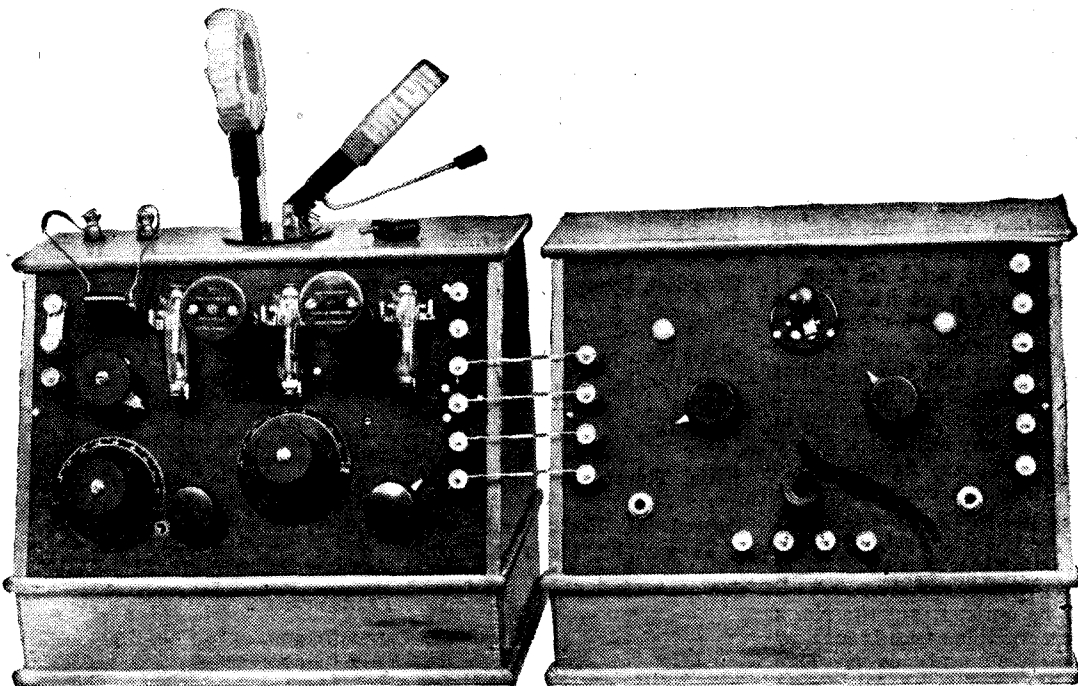

*The complete Transatlantic receiver, showing long-wave modification and note magnifying unit added.*

stages is introduced between the aerial and the detector, a very small reaction coil will be needed and it will be found that if a small coil is chosen the adjustment of reaction is very smooth without overlap. Naturally, one must take all precautions to avoid radiation on concert wave-lengths, and the reader is strongly advised to disconnect this two-coil holder when receiving broadcasting, for it is not necessary to obtain reaction in this way on that particular band of wave-lengths.

The accompanying table taken from actual measurements on my receiver gives the approximate position for various British and Continental broadcasting stations. In order that one may be able to utilise full range of reception, it is necessary to obtain the complete set of high-frequency transformers in duplicate. There are five different transformers in this set.

When you have made the slight alterations described, be quite sure that your reaction is connected the right way round. It is by no means obvious that you have the right connection by testing in the usual way, for you can obtain capacity reaction quite readily when the coil is so connected that magnetic reaction is impossible. If you have the coil the right way round you will find a very gradual increase of reaction effects as you approach the moving coil to the fixed. It will be rarely necessary to use a larger coil than about a 35 or 50 Igranic even on the Eiffel Tower wave-length. A vernier adjustment of reaction is obtainable on the potentiometer, and after a little practice you will find it possible to obtain extremely fine reaction on this set. In fact, I have never used a set which gives such fine control.

Any good make of coil can be used in this set, and the fact that I have indicated Burndept concert coils in some cases and Igranic in others is not any indication of my preferences. These figures were given because the coils happened to be on hand when I was carrying out the particular test. I have used Gambrell, Atlas and Pye coils equally successfully.

It will be noticed that the No. 5 transformer of this series is marked 2,000 metres and over. This particular transformer is almost aperiodic, being wound with resistance wire. For this reason

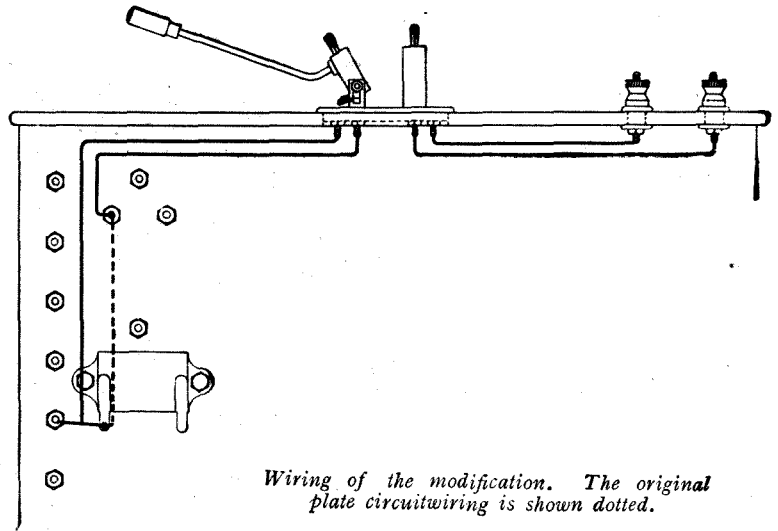

it covers a wide band of wave-lengths, but for very long waves I would recommend a resistance capacity coupling, the practical form of which, for use in this set, I hope to describe next month. With this resistance capacity coupling it will be possible to

receive with high efficiency the longest wave-lengths now in use, one set of coils, the transformers, and this coupling covering the whole range of wave-length from 150 metres to 30,000 or more. The instrument is thus a true universal set of very high efficiency.

APPROXIMATE CALIBRATIONS.

Station.	Coil.	A.T.C.	Transformer.	H.F.C.
	Burndept Concert Coils.			
Cardiff .. .. .	2	46	2	40
London .. .. .	2	84	2	54
Manchester .. .. .	2	90	2	56
Bournemouth .. .. .	3	26	2	60
Newcastle .. .. .	3	40	2	66
Glasgow .. .. .	3	50	2	72
Birmingham .. .. .	3	60	2	78
Aberdeen .. .. .	3	126	2	110
	Burndept.			
Croydon, Lympne, etc.	75	118	3	110
	Burndept Concert Coil.			
Ships (600 metres) ..	4	36	3	24
	Igranic.			
Hague .. .. .	100	110	3	170
Radiola .. .. .	200	30	4	88
	Burndept.			
Eiffel Tower .. .. .	300	44	5	0
	Burndept Concert Coil.			
School of Posts and Telegraphs, Paris ..	3	100	2	84
	Transformers.			
1.	150 to 300.			
2.	300 to 600.			
3.	550 to 1100.			
4.	1000 to 3000.			
5.	2000 and over.			

# THE MEASUREMENT OF WIRELESS QUANTITIES

By E. H. CHAPMAN, M.A., D.Sc., F.R.Met.Soc.

This is the third of Dr. Chapman's articles on measuring wireless quantities. Previous articles appeared in July and August.

## III.—RESISTANCE.

ONE of the most engaging things about wireless is the way in which an experimenter can get excellent results without the least knowledge or appreciation of the numerical values of the electrical quantities involved in the construction of the apparatus he uses. If, for example, a wireless enthusiast is asked to state the best range of resistance values for a filament rheostat, his reply is very likely to be to the effect that he neither knows nor cares, but that he can tell you where you can get a good filament resistance for such and such a price.

It speaks most eloquently for the skill of the technical designer and for the work done by the manufacturer that the wireless experimenter can get along so well with no more knowledge of the electrical properties of his component parts than the manufacturer chooses to tell him. Yet the average experimenter is very much like the man who invariably purchases ready-made clothing and who has never experienced the delights of a suit made for himself and for no other man on earth.

Every experimenter knows that a good average value for the resistance of a grid leak is in the neighbourhood of two megohms; yet how many of those experimenters think of and understand the difference between a megohm resistance in a grid leak and an ohm resistance in a filament rheostat?

The text-book tells us that a megohm is a million ohms. The

dictionary tells us that a millionaire is a man who possesses a million pounds, yet this dictionary definition will no more help us to pick out a millionaire in a Lyons teashop than the text-book definition of a megohm will enable us to pick out a megohm resistance from

megohm resistance of an insulator. In order to see that this difference is very great, it will perhaps be best to make comparisons between things we can visualise. A foot of 44 S.W.G. copper wire has a resistance of very nearly 1 ohm. To get a megohm resistance with this wire, a length of 190 miles would be required. Eureka high resistance wire of 22 S.W.G. has a resistance of a little over 1 ohm per yard. In making a filament rheostat, about 7 yards of this wire would be needed. A resistance of 2 megohms would call for 520 miles of such wire.

The formula for the resistance of any substance is a very simple one, depending only on the length of the portion used, on the area of the cross-section of that portion and on the substance itself. Yet it is seldom practicable to calculate resistances from the formula since the lengths involved are usually great and in so many cases the conductor is done up in inaccessible form, as, for example, the wire in a tuning coil.

Now the materials used in wireless work may be classified roughly as conductors and insulators, the former having comparatively low resistances and the latter comparatively high resistances. A comparison of the resistances of some of the well-known materials, conductors and insulators, may be made from the figures given in Table I.

It will be readily understood that the methods used for the measurement of the resistance of

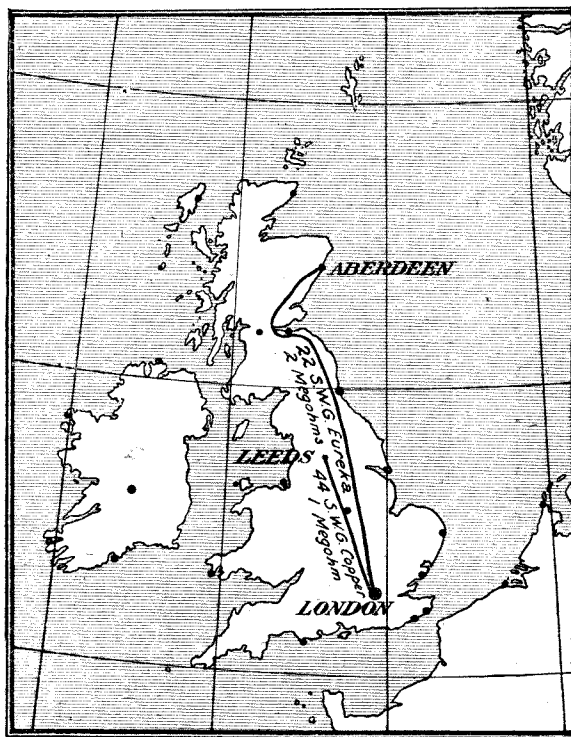

FIG. 1.  
To get 1 Megohm Resistance with 44 S.W.G. Copper Wire a Length of Wire Reaching from London to Leeds would be Required. To get 2 Megohms Resistance with 22 S.W.G. Eureka Wire a Length of Wire Reaching from London to Aberdeen would be Required.

the junk box of a wireless experimenter.

With regard to the measurement of resistance, the first essential is to get a very clear idea of the difference between the ohm resistance of a conductor and the

a conductor in ohms will not necessarily be applicable to the measurement of the resistance of an insulator in megohms. Most experimenters are familiar with the practical methods of measuring the resistances of metallic conductors. The resistance of a coil of copper wire may be measured by placing the coil in series with a Daniell's cell and a milliammeter and connecting a millivoltmeter to the ends of the coil. If the reading of the millivoltmeter be  $E$ , and the reading of the milliammeter be  $I$ , the resistance of the coil in ohms will be  $E$  divided by  $I$ . Should the ranges of the two instruments be unsuitable, an extra resistance has to be put in series with the coil. It is scarcely necessary to mention that the most accurate and convenient method of measuring resistances is by means of some form of Wheatstone bridge and standard resistances.

Recent developments in wireless receiving circuits have called for high resistances, both fixed and variable, of somewhat different values from the standard 2 megohms grid leak. The measurement of such high resistances has become rather important.

The high resistances used in wireless circuits run from about 50,000 ohms to 5 megohms. It is interesting to note from Table I that it is as useless searching for a high-resistance material amongst the insulators as amongst the conductors in that table. There are, indeed, very few substances which possess the resistance property required for grid leaks and other such high resistances. One substance which has been used a great deal is graphite. A bar of graphite 10 centimetres long and 1 square millimetre in cross-section would have a resistance of 2 or 3 ohms. Graphite, however, can be used in the form of a thin film or as a pencil line and high resistances so obtained. Another substance which has been used a great deal of late is blotting paper or thin card soaked in indian ink. As with graphite, no guiding values can be given because of the variation in the composition of the material and in the manner in which it is applied.

The more one goes into the question of high resistances, the more one realises how dependent the wireless experimenter is on the accurate measurement of such resistances by reliable instruments.

For accurate measurements of any kind, accurate measuring instruments are absolutely necessary, and the greater the accuracy of an instrument the greater is its cost likely to be.

For the measurement of resistances of the order of several megohms, it is possible to employ a substitution method. A very sensitive reflecting galvanometer and a cell are required. The unknown resistance,  $R$  megohms, is placed in series with the cell and the galvanometer and the deflection of the galvanometer is noted. Next, the unknown resistance is replaced by a known standard resistance of, say,  $r$  megohm. The deflection is again noted. The value of  $R$  in this case would be the second angular deflection

and range for such an instrument being 0-40 megohms. Megger testing sets are, however, expensive things. They are doubtless beyond the means of the average experimenter, although a radio society might find it possible to purchase one for the use of its members.

Theoretical considerations suggest that the solution of the problem of measuring high resistances with simple apparatus may be found in the use of a standard condenser of careful design. The time taken to charge up a condenser to a given pressure depends on the product of the capacity of the condenser and the resistance through which it is charged. Suppose that a condenser of capacity  $C$  microfarads is being charged through a resistance of  $M$  megohms and that the

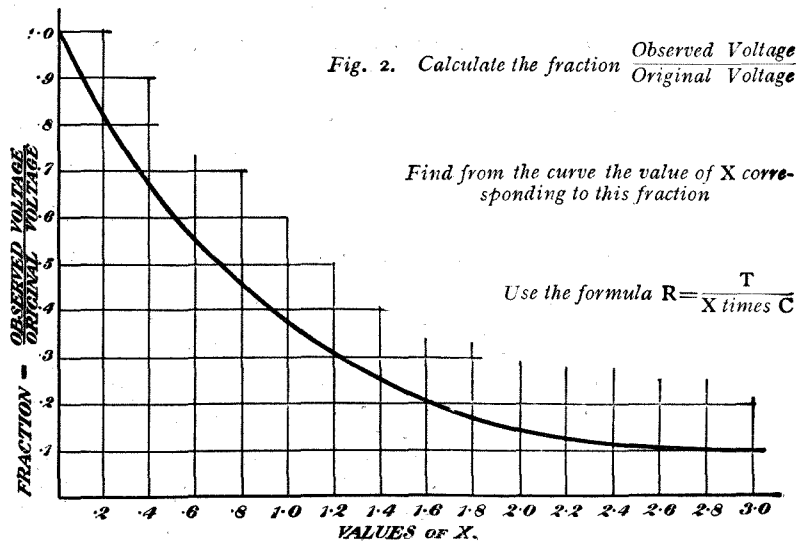

divided by the first angular deflection. In general, if  $R_1$  be the known standard resistance in megohms, the value of  $R$  would be  $R_1$  multiplied by the second angular deflection divided by the first angular deflection.

Amongst electrical instruments for the measurement of high resistances there is the "megger" testing set, which contains an ohmmeter and a magneto-generator giving anything up to 1,000 volts. The magneto-generator is a direct current machine geared to give, in the more expensive instruments, a constant speed of turning and therefore a constant pressure. There is also the "bridge-megger" testing set, which combines the functions of a "megger" with those of a Wheatstone bridge, the stand-

time taken in making the terminals of the condenser show a potential difference equal to the steady applied voltage is  $T$  seconds, then  $T = 5 C M$ .

If a condenser of 1 microfarad be used, the time  $T$  divided by 5 gives the value of the unknown resistance in megohms.

An alternative method may be developed from the following:

Charge the condenser of known capacity and allow the charge to leak away through the high resistance whose value is to be found. After an interval of  $T$  seconds, observe the terminal voltage of the condenser. Work out the fraction

$$\frac{\text{Observed voltage}}{\text{Original voltage}}$$

and from the accompanying curve

(Fig. 2) find the corresponding value of X. Substitute this value of X, the value of T in seconds and the capacity value of C of the condenser in microfarads in the following formula:

$$R \text{ (megohms)} = \frac{T \text{ (seconds)}}{X C \text{ (C in microfarads)}}$$

A numerical example might help to make the calculation clear. A condenser of capacity 2 microfarads is charged up and on discharging through an unknown resistance it is noted that after 8 seconds the terminal voltage of the condenser is  $\frac{1}{2}$  of what it was originally. From the curve we

have for a value of the fraction

$$\frac{\text{Observed voltage}}{\text{Original voltage}}$$

equal to  $\frac{1}{2}$ , a value of X equal to 1.38.

By putting X = 1.38, T = 8 and C = 2 in the formula we get

$$R = \frac{8}{1.38} \text{ times } 2. \\ = 3 \text{ megohms very approximately.}$$

EDITORIAL NOTE.—In our October issue Mr. Cowper described a practical method of measuring high resistances with a Neon lamp.

TABLE I.  
RESISTANCES.

The resistances given are for bars of the material 10 centimetres long and 1 square millimetre in section.

NOTE.—A billion is a million millions.

CONDUCTORS.		INSULATORS.	
Silver .. ..	.0016 ohms.	Celluloid ..	20 million megohms
Copper .. ..	.0018 "	Glass ..	Up to 50,000 million megohms.
Gold .. ..	.0024 "	Porcelain ..	300,000 million megohms.
Tin .. ..	.0113 "	Mica ..	1 billion megohms.
Nickel .. ..	.0118 "	Shellac ..	10 "
Steel .. ..	.0199 "	Ruby mica ..	50 "
Lead .. ..	.0208 "	Hard rubber	1,000 "

with a resistance of about 200 ohms will do, but the most convenient type of instrument, since it can be mounted below the panel with only its knob appearing on its upper side, is that about to be described.

The former is a piece of  $\frac{1}{4}$  in. ebonite, 3 $\frac{1}{2}$  inches long and 1 inch wide. On to it are wound about 200 turns (the exact number is not important) of No. 30 enamel covered resistance wire. This will give a total resistance of about 200 ohms. The ends of the wire are anchored to two small tags. These are to be used also for soldering on connections. The arm can be made from one of those intended for multi-stud selector switches that can be purchased from advertisers in this journal for about a shilling. To adapt it one simply

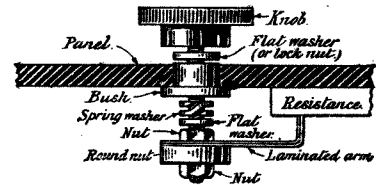

Fig. 2.—Details of fixing.

arranges its parts as shown in the drawing. The hole for its bush is drilled in the panel  $\frac{5}{8}$  in. below the lower end of the resistance-wound former, when it has been fixed in position by means of screws. The enamel is scraped off the wire along the curved path taken by the laminated arm. The arm itself should be reduced somewhat in breadth with a file, so that it does not make contact with a great number of turns at one time.

The series resistance is very simple to use: one simply throws in the smallest possible amount of

(Continued on page 165.)

## CONTROLLING TUNED ANODES

THERE can be no doubt that the tuned anode method of coupling high-frequency valves has very great advantages over other systems. It is cheaper, it gives a greater volume of sound to the set, valve for valve, and it is more selective than other coupling circuits. It has, however, one strong disadvantage. Owing to the internal capacity of the valve, which provides a coupling between grid and plate, oscillation is very liable to occur when both their circuits are tuned exactly to the frequency of an incoming signal. A single tuned anode stage controlled by a grid potentiometer is not too difficult to handle, but when two are in series the set becomes very hard to control, and to add a third is almost outside practical politics.

After trying a good many of the various methods of control the

writer has come to the conclusion that the only one which is really satisfactory is to use a variable resistance in series with the anode inductance. Fig. 1 shows the variable resistance control of two tuned anodes. Any potentiometer

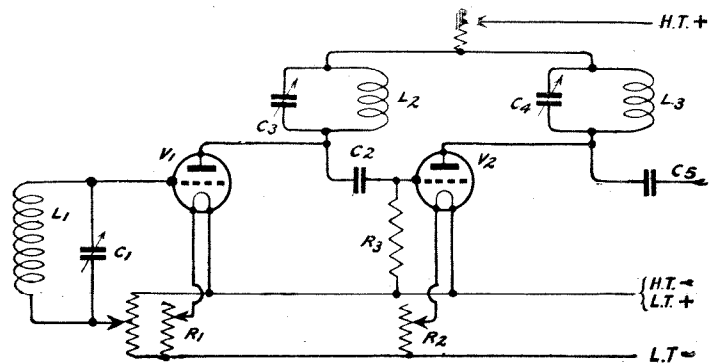

Fig. 1.—The position of the resistance.



# LOUD-SPEAKERS

and How they Work.

By E. ALEXANDER.

*In this article the writer describes a number of interesting experiments with home-made loud-speakers, and explains the principles upon which the commercial types are based.*

**I**N the everyday language of wireless a loud-speaker is an instrument which will distribute the sound reproduced over a large area and with sufficient volume to enable the sound to be heard without the necessity of wearing the head-phones. The head-phones function in exactly the same way as a loud-speaker, but the column of air to be vibrated is so much smaller that a less powerful reproducer is needed to make the sound comfortably audible. In addition, the column of air is entirely enclosed, while in the case of the loud-speaker the sound has to be broadcast into the surrounding air.

It is a common fallacy that loud-speakers are a wireless invention. This is very far from being the case. Loud-speakers were in use long before wireless was invented, and have been in successful operation ever since. The gramophone is a typical example. Before the advent of wireless, electrically operated loud-speakers were used on ships where they were, and still are, needed for transmitting orders, thus obviating the necessity of holding a telephone receiver to the ear when listening. This type of loud-speaker attained a very high efficiency and undoubtedly formed the basis of some of the better instruments now used in wireless.

It will help us towards an understanding of loud-speakers if we run over the properties, make

up and action of the ordinary type of telephone receiver. The first essential is to impart vibrations to the air. This is generally done by hitting it! The action is usually, alas, performed by means of a metal plate generally known as a diaphragm, which "hits" the air by its movement and imparts the necessary vibrations to it. The vibrations thus created travel as waves through the air

its periphery, is supported above and close to an electro-magnet consisting of a permanent magnet (to give a constant tension to the diaphragm), with an electro-magnet superimposed upon it to vary the pull or, in other words, to vibrate the diaphragm. The varying current which comes from the wireless receiver passes through the coils of the super-imposed electro-magnet, thus vibrating it and reproducing the sounds originating from the broadcasting station.

A telephone receiver or loud-speaker is therefore an exceedingly simple piece of apparatus, and considering the range of sound that it reproduces, a wonderful example of human ingenuity.

It may be thought that from the foregoing remarks the making of an efficient loud-speaker is a simple matter requiring small skill and certainly no experiment and research. This is very far from

being the case. Simple though the actual operation of a loud-speaker may be, the instrument itself is most difficult to design, and endless trial and experiment is needed to produce an article in any degree efficient. My first home-made loud-speaker was built in 1915, the making up consisting of attaching an empty tin (plum and apple) to an ordinary ear-piece. Later I became more ambitious, and the horn portion became a biscuit tin of larger volume. Crude though these

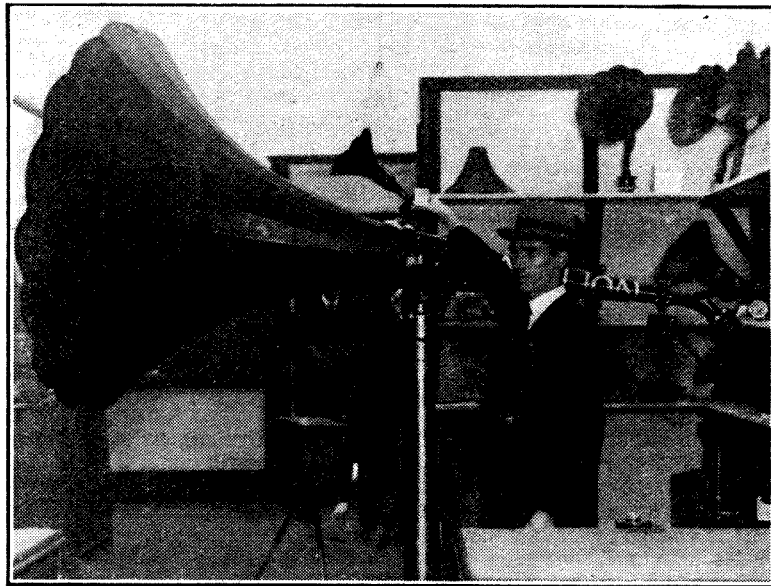

*A giant loud-speaker at the All-British Wireless Exhibition.*

and, impinging on our ears, convey to us the sensation of sound. In the case of head-receiver telephones the air thus hit is, in form, a small column enclosed in the chamber formed by the head-phones and our ears. In the case of the loud-speaker, however, the air thus hit and vibrated is of an immensely larger volume and is only enclosed (when it is in use indoors) by the walls of the room.

The movement of the diaphragm is obtained by magnetic action. An iron diaphragm, clamped around

devices were, they served their purpose admirably, on two occasions being used to broadcast

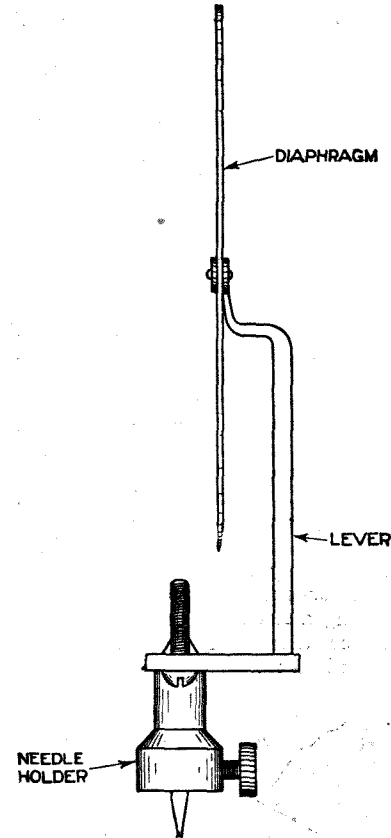

Fig. 1.—The gramophone reproducer, showing how a column of air is set in motion.

(over land line) a concert in the trenches.

These experiments were my first real introduction to the problem of "loud-speaking," and experiments have continued ever since. The end of 1918 found me trying to produce a distortionless instrument for speech, and here my real difficulties started. Incidentally,

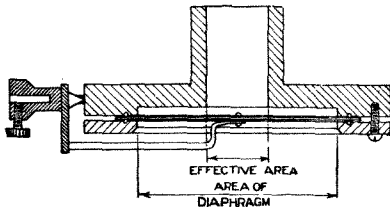

Fig. 2.—Showing how the useful area of a diaphragm is reduced to about  $\frac{1}{2}$  in. diameter.

judging from the reproduction given by the various models then marketed, I was not entirely alone in my difficulties.

It may be interesting to give an account of some of the outstanding points in my experiments, as it may lead some thoughtful person to produce a new device working on a new principle, more satisfactory than any yet.

We have already seen that the fundamental principle of sound reproduction is that something is made to "hit" the air and thus produce vibrations. These vibrations are of a frequency depending on the nature of the impact, and the problem to solve is the best means of "hitting" or imparting the necessary vibrations to the air. Musical instruments, generally, employ one of two methods of setting the air in motion. Either a reed or string is vibrated and this hits the air; or a column of air is set in motion (either by the player's lungs or an air pump) and is made to impinge upon a sharp edge, the impact causing the air to

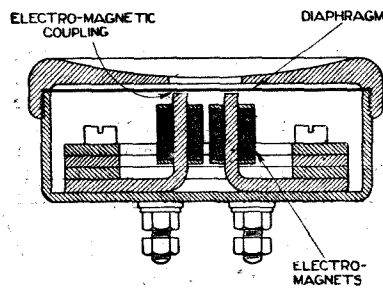

Fig. 3.—An example of electro-magnetic coupling.

vibrate. Such methods can only produce a limited range of note or frequency of vibration owing to the nature of the string, reed, or column of air, and are obviously unsuitable to reproduce the multiplex vibrations covering the whole of the audible range of sound. Another method has had to be sought wherein the member which impacts the air has no particular natural frequency and can be vibrated over the whole range of audible sound.

This problem first presented itself when the telephone and the gramophone were invented, and the method employed, developed and adhered to has been the diaphragm. A small circular flat plate about 2 ins. in diameter is clamped at its periphery, motion (vibrations) are imparted to its centre, and being thus set in motion it strikes the air and vibrates it, reproducing the original vibrations of the voice or musical instruments.

On examining the action of a diaphragm one is surprised at the excellence and efficiency of its

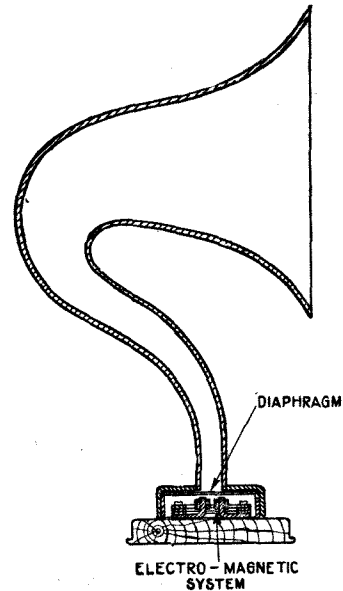

Fig. 4.—The usual loud-speaker system.

reproduction. In the first place, being clamped about its periphery it is damped. This is actually an advantage. When the diaphragm is vibrated a series of ripples, similar to those ripples produced when a stone is thrown into a pond, are formed in the diaphragm and spread outward over it. These ripples die away slowly towards its periphery and, as all the vibrations are of different frequencies,

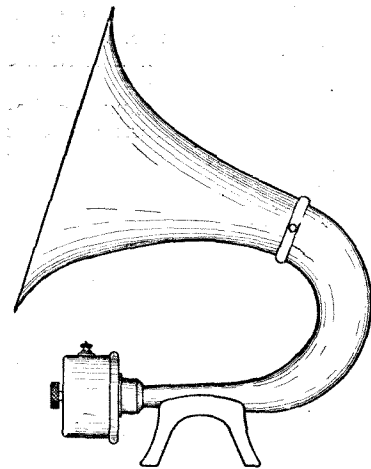

Fig. 5.—Another commercial type.

some tend to die away earlier than others. There is thus a tendency to catch up with the slower ones. When this super-

imposition occurs some notes are either unduly reinforced or nullified, the resultant sound being either too strong or too weak. In either case it is not the right note, and is an undesirable one. The damping action tends to minimise this. Again, as it is impossible to obtain a material for the diaphragm which will not introduce a natural frequency of its own, certain notes impressed on the diaphragm will coincide with this natural frequency

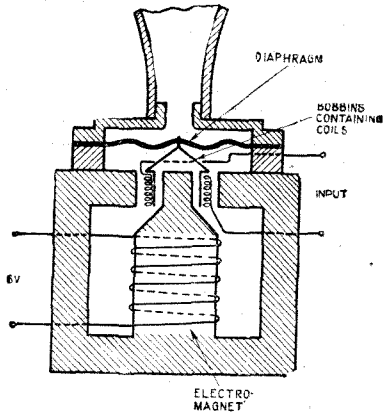

Fig. 6.—A directly mechanically-coupled loud-speaker system.

and harmonics will result. Generally a fairly high-pitched ringing note is produced.

To avoid these difficulties the useful area of the diaphragm has to be reduced to about half an inch diameter, which means that this area of any diaphragm is only about 1-16th of the total area. The whole of this useful area is concentrated about the centre, where the means of setting it in motion are in all cases situated.

The means of actuating the diaphragm are two—electro-magnetic and mechanical. In either case the coupling has to be of a very positive nature or subsidiary vibrations would be set up conflicting with the main vibrations. More depends on this coupling than is generally supposed, and often the poor results obtained can be directly traced to this source.

The gramophone and some loud-speakers are examples of the direct mechanical coupling, and the telephone an example of electro-magnetic operation. In the case of the direct mechanical coupling, a rod, lever or reed is rigidly clamped to the centre of the diaphragm, and in the case of electro-magnetical coupling the diaphragm, which is, in this case,

a thin sheet of soft iron, is disposed in a magnetic circuit of which, in the better types, it forms the major part.

compromise essential, for if the diaphragm is near the poles of the magnet and the gap therefore small, the diaphragm occasionally

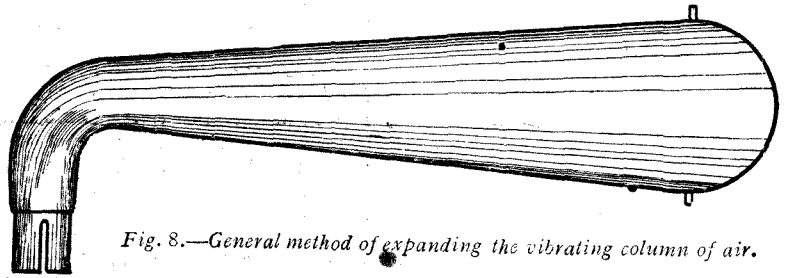

Fig. 8.—General method of expanding the vibrating column of air.

The particular disadvantages under which the direct mechanical type works are the nature of the material and the necessity of rigid coupling. The nature of the material is such that it must have a natural frequency of its own, and the rigid coupling produces distortion. Nevertheless, this type suffers less than the electro-magnetic type, as in the latter type the diaphragm must of necessity be iron, a very poor substance with which to produce pure tones. Mica, glass, etc., can of course be used in the mechanical types.

In the case of the iron diaphragm the nature of its method of operation necessitates the gap in the

strikes the pole pieces, and if situated at any distance from them, the pull is tremendously diminished. Means of adjustment of the gap are usually provided.

The actual construction of the various types of loud-speaker varies with each make of instrument. Mainly, however, they fall into three categories. The first of these is generally nothing more than a superior single telephone receiver, having a horn or sound expanding device attached thereto. The second is an electro-magnetic system attached directly and mechanically to a diaphragm, also with a horn attached, and the third is an electro-static method mechanically coupled directly to a diaphragm to which the usual horn is attached.

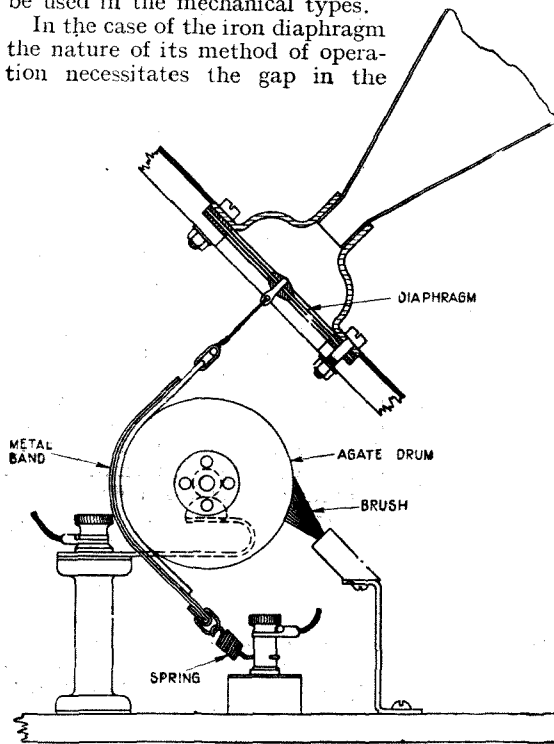

Fig. 7.—An electrostatic loud-speaker.

magnetic field being a minimum, a rapid diminution of strength of pull being caused by an increase in the air gap. This makes a

of the lines of force through it, thereby increasing its sensitivity; a further refinement consists in placing a reed between the pole

The telephone watch receivers again fall into two main categories. There is the type where a permanent magnet has soft iron pole pieces attached to it, on which are wound coils of wire; these coils being connected to the source of varying current. The pole pieces are disposed at the centre of the diaphragm. A refinement of this type is that wherein the magnetic circuit is completed via the diaphragm, thus concentrating the whole

pieces and attaching the reed to the diaphragm.

The type which employs an electro-magnetic system directly mechanically coupled to a diaphragm has an electro-magnet,

the same limitations as any other diaphragm.

Having now considered the various methods of "hitting the air" let us see how the waves are expanded from the small column

immediate neighbourhood of the horn.

Here again most of these types work under disadvantages. As is the case with an organ pipe, the column of air in the horn has a

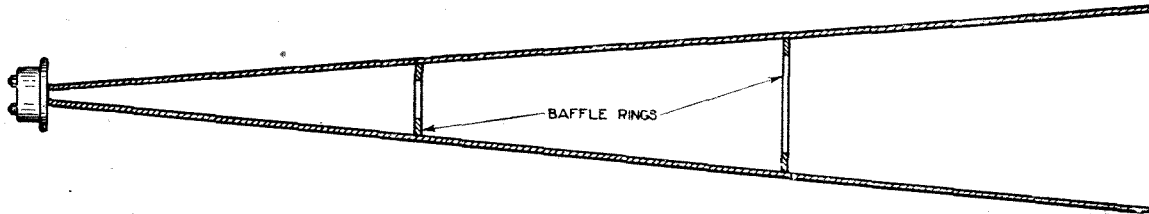

Fig. 9.—Showing baffle rings in the horn.

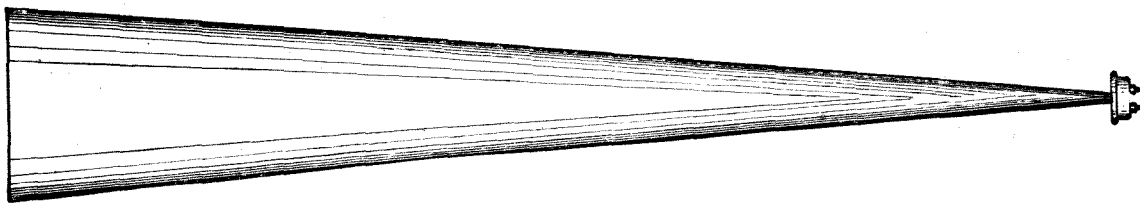

Fig. 10.—Exterior of the resultant loud-speaker.

generally pot-shaped and energised from a separate source. Suspended in this field and directly mechanically coupled by a rod or lever to the diaphragm, is a coil of wire connected to the source of varying current. Here the action is that the varying current in the suspended coil produces a varying magnetic field which interacts with the magnetic field of the main electro-magnet and by reason of the direct mechanical coupling vibrates the diaphragm.

The electrostatic method employs a peculiar principle of surface attraction. In construction it usually takes the form of an agate cylindrical drum over which a copper, or similar metal, band is wrapped. The cylinder is revolved by a small motor or clockwork at a uniform rate. To one end of the band is directly coupled mechanically a diaphragm, the band being secured at the free end by a fairly stiff spring. Contact is made to lead the band and by means of a brush or similar suitable method to the cylinder; as the current varies the attraction of the band to the cylinder varies with it, and the drag on the diaphragm due to the rotation is accentuated and reduced. This method gives good results, but is not universally applicable, owing to the noise of the motor and attendant difficulties of driving the cylinder. Furthermore, the diaphragm suffers from

which is hit by the centre of the diaphragm.

Apart from one or two "freak" methods of expanding the volume of air, in general, in both gramophones and loud-speakers, the air is contained in a tube which takes the shape of a horn.

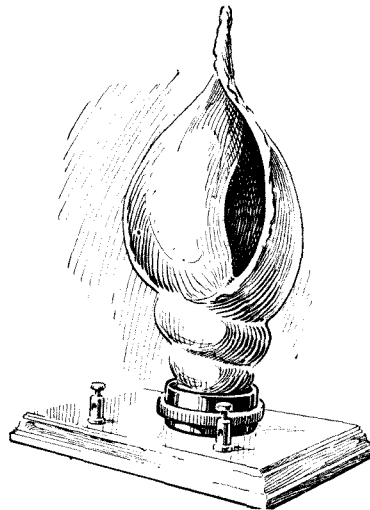

Fig. 11.—A shell loud-speaker.

The short column of vibrating air is connected to a larger column in the expanding tube and vibrates this larger column of air; the larger column of air at the mouth of the horn vibrates the air around it, the sound is expanded, and thus fills a room or spreads around the

natural frequency of its own and is liable to resonate at that frequency, also the shape, or "flare" as it is called, of the horn affects the tone. The material from which the horn is constructed may vibrate on certain notes owing again to a natural frequency of its own, and any movement, extraneous sound or jar, impinging on the walls of the horn, produce similar but magnified sounds in it.

The first series of experiments undertaken was confined to the horn. A good sensitive watch receiver had a face plate, attached to the ebonite cap, so constructed that a variety of horns could be attached. A horn of expanding diameter from  $\frac{1}{2}$  in. at the face plate to 2 ft. at the open end and 12 ft. long was constructed of stiff dry cartridge card, and when completed was given two coats of spirit varnish to stiffen it and keep out moisture. This was suitably suspended and a series of voice and musical tests given it. Magnification was considerable and tone fair, but extraneous sounds so magnified that often a cough would render the music inaudible and any diaphragm fault or rattle was amplified a hundredfold. There was also a tendency to prolong certain notes, making the reproduction impure. The tube was now gradually cut down foot by foot and tests made at each alteration. When it was about 5 ft. in length, the best all-

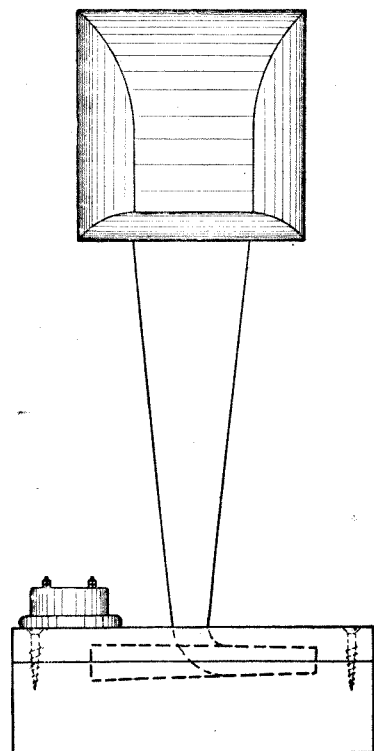

Fig. 12.—A loud-speaker of unique design.

round results were obtained. Continuing this experiment, the inside of the horn was given a coat of paste and sand thrown on it, thus roughening the inside surface. Tone and clarity were greatly improved thereby, with no loss of volume.

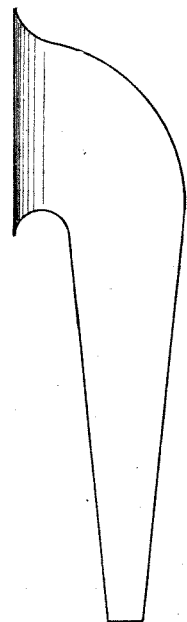

Fig. 13.—Side view of horn.

Another method of eliminating disturbing vibrations was to introduce baffle rings into the horn, thereby dividing it up into compartments. There is little to choose between the two methods; roughening is easier to do, and I am not sure that scientifically it is not more correct.

The next experiment took the shape of fitting a watch receiver to the mouth-piece of a brass musical instrument. This confirmed my views with regard to the expanding horn, and I put down the defects it revealed to the smooth inner surface and the fact that its coiled length was not suitable for a large range of sound reproduction.

From these experiments I concluded that the horn should be 5 ft. long, should have a roughened interior and a fairly solid wall.

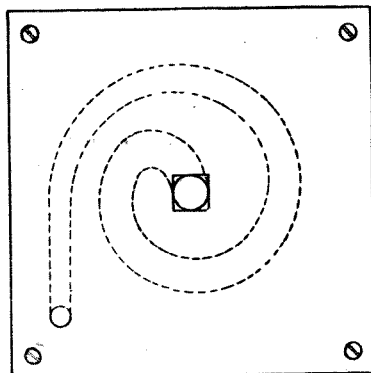

Fig. 14.—Base of instrument.

In order to contain a 5-ft. horn in a reasonable space and produce an instrument that has a decent appearance, I decided that it should be made on the following lines. A short expanding diameter horn with a right angle flare orifice. Contained in the base the remainder of the 5 ft. of horn in the shape of a spiral expanding tube, the operating diaphragm of the telephone receiver being situated at the small end of the spiral tube and the upstanding horn at the larger end. The upstanding horn can be of square section and can be built of fairly thin wood or stiff card. The spiral expanding tube can be made in two halves by any worker in wood and glued together.

There is no need to more than mention the various methods of adapting existing sound reproducing apparatus, such as the gramophone. They are all good as ordinary horn reproducers go,

and are now a commercial product, to be obtained anywhere. Any existing sound reproducer can be converted for wireless reproduc-

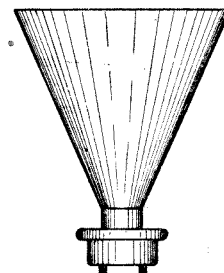

Fig. 15.—Ceiling dispersion and reflection loud-speaker.

tion with more or less good results, depending on the instrument in question.

My next experiments centred round making a horn reproducer of more convenient shape and appearance than those commercially exploited. They took various forms, such as a large shell, now well known, and which gives very excellent tone, but is rather noisy. Consideration of space produced two other types, one shaped like a flattened capital C, with the telephone receiver disposed vertically at the tail of the C. I was not impressed with this. Another, and very successful type, consisted of a bowl of regular concave interior surface. The telephone receiver with a short horn attached is situated at the radial point of the concave with the horn pointing inwards. This method can

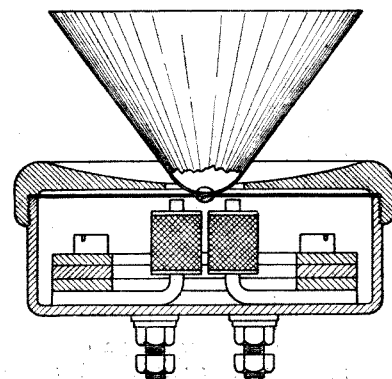

Fig. 16.—Cone on diaphragm loud-speaker.

be focussed like a searchlight, and gives very even dispersion and quite good volume and tone. To a large extent also it eliminates



distortion. A variation of this method, and one which I apply with great success, is to suspend the telephone receiver and short horn

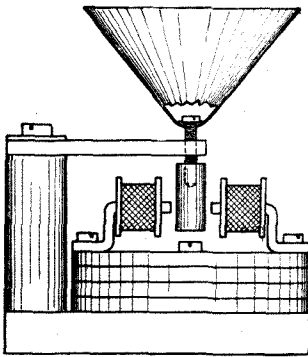

Fig. 17.—Cone and armature loud speaker.

near, and pointing at, the ceiling. The sound is well spread out and reflected, and has the advantage of being distributed by a solid smooth surface.

I have not tried any electrostatic methods, as the only one I know, as previously explained, has to have a motor to operate it. I am striving for simplicity as well as perfection, and have no use for a method which involves a driving motor, be it electric or clockwork.

My attention next turned to hornless devices, with the following results. An ordinary watch receiver had a small hole drilled in the centre of the diaphragm. By means of this hole a stiff paper cone was attached to the diaphragm so that the whole cone vibrated

and affected the surrounding air. Although not very loud, this device proved quite efficient for certain purposes. A development of this was an electro-magnetic system made up from the parts of a watch receiver in such a manner that the pole pieces pointed inwards. A soft iron armature was suspended between these pole pieces, the armature having a stiff card cone attached to its upper end.

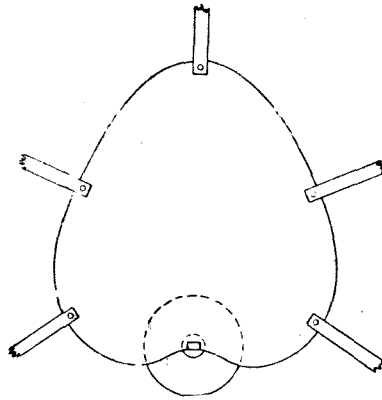

Fig. 18.—Heart-shaped board type loud-speaker.

The cone and armature were supported by a wooden bar spring. Mounted on a wooden base and stood on a table, this device, while again not very loud, had an exceeding soft and clear tone. I think there are possibilities in this direction.

Two more efforts concluded broadly my main experiments. They are the same in principle but different in application. A stiff heart-shaped card was sus-

ended rigidly from points around its periphery. At the root a piece of soft iron forming an armature was attached. A watch receiver minus diaphragm was disposed with as small an air gap as possible opposite the armature; it should be adjustable as to position. The results with this were the best so far obtained.

Continuing, I tried a resonator, using the same principle, and bent up a fairly thick sheet of wood about 14 ins. square with a short-long-short ripple in it. The armature was attached to the peak of the first short ripple and a watch receiver with poles arranged to point inwards disposed about the armature. I like this instrument better than any of the horn variety, and propose to devote my future attention to similar devices.

There is a long way to go and little has been done. May I ask others who have tried, to record their failures and successes for the general good. Several of the devices which I have described form, I believe, the subject matter of patents. I have, however,

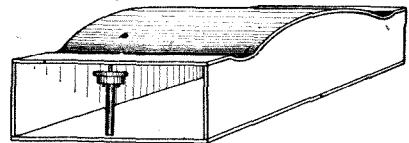
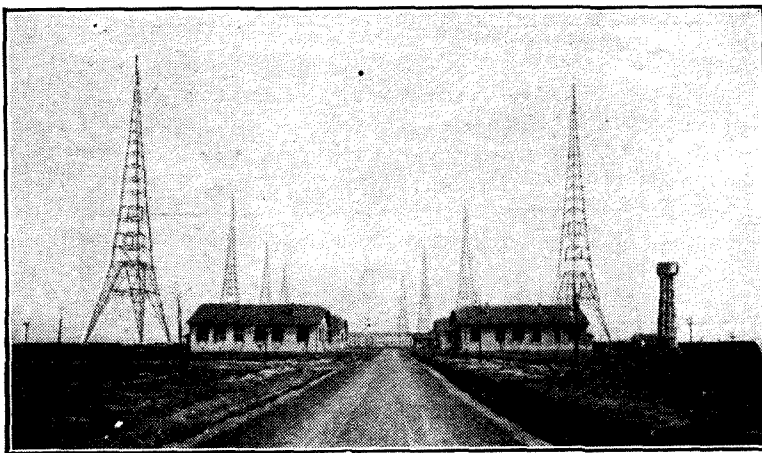

Fig. 19.—Wooden resonator loud-speaker.

merely been striving along certain lines for definite results, and one thing suggests another. Thus one is led along to keep on trying.

(Continued from page 159.)

resistance to prevent oscillation. When you start tuning use all or most of the resistance. Then when the best adjustment of the condensers has been found, reduce it gradually until you have just sufficient to allow the knob of either condenser to be turned without producing squeals in the receivers. Once the correct adjustment of the resistance has been found, it will remain very nearly constant, only slight variations being necessary to keep the set in full control at all times. If a good deal of resistance is used, when searching operations are in progress, one need have no fear of causing interference with others, such as usually occurs with the uncontrolled set. R. W. H.



The giant masts at "LY" (Bordeaux), a station which has been heard in Australia.

# SOME AMERICAN SINGLE-VALVE CIRCUITS

By A. D. COWPER, M.Sc., Staff Editor.

*A critical commentary on several interesting new arrangements.*

THERE has been a revival of interest recently, so far as English radio literature is concerned, in various modifications of the famous De Forest Ultraudion circuit, long popular amongst American amateurs, for whose standard type of equipment of variometer and soft detector—"toobs" it is peculiarly adapted. For short-wave reception in a crowded and unregulated ether, some type of this Ultraudion with only electrostatic reaction (all tuning being carried out with a single variometer and a variable reaction-condenser), provides a simple and quite sensitive circuit. However, it must be approached with some caution if proposed seriously for use in broadcast reception on this side of the water.

The standard types of De Forest circuit are shown in Figs. 1 and 2; the particular arrangement may seem at first glance a trifle unfamiliar, but they are arranged here in this manner for the sake of clearer contrast with the later developments, Figs. 3 and 4.

The latter circuits are obvious modifications of the original Ultraudion, associated with the names of May and Albright respectively; and some lively claims have been brought forward recently as to their merits.

The original De Forest circuit No. 1 is not suitable for English valves and components: on trial with an R valve and reasonable H.T. it will be found hard to make it oscillate when direct coupled to a P.M.G. aerial, even with grid-leak of 2 megohms to the L.T. plus, which is the best arrangement for our valves. No. 4 is simply this circuit with the variable condenser, which controls simultaneously reaction and wavelength, in series with the aerial and A.T.I., in place of in parallel, as in No. 1. Accordingly, with a hard valve (with little grid-damping) there is a greater voltage build-up than in the latter case,

and the circuit oscillates more readily.

In the May circuit, for some reason difficult to fathom, the same circuit is used with the curious modification that the connection from the anode to 'phones and H.T. battery is taken through the A.T.I., in place of the shunt arrangement of the other circuits.

Most careful comparative trial on test transmissions from the further broadcast stations, oft repeated to eliminate chance variations, have failed, in the writer's experience, to substantiate in the least the claim that a single valve, with proper value of H.T. and grid-leak, will give louder and clearer signals with this type of capacity reaction in place of the

more usual magnetic reaction, if both are properly applied with delicately critical adjustment and with equally efficient tuning devices (as far as that can be assured). Any difference in operation is merely due to relative ease of tuning and convenience of the particular device used. The Ultraudion circuit No. 2 certainly offers no material advantage over the two-coil tuner and series condenser of conventional English design, given good low-resistance coils and variometer respectively, besides being appreciably harder to control.

On practical comparison of Nos. 3 and 4, using for variometer an older pattern of small Igranic moulded ball-rotor instrument

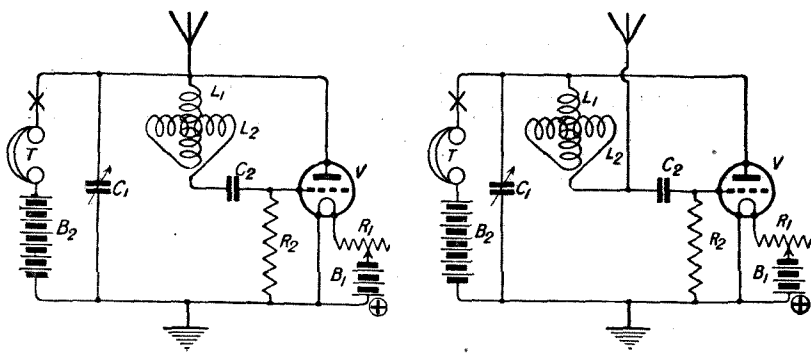

Figs. 1 and 2.—Standard De Forest Ultraudion.

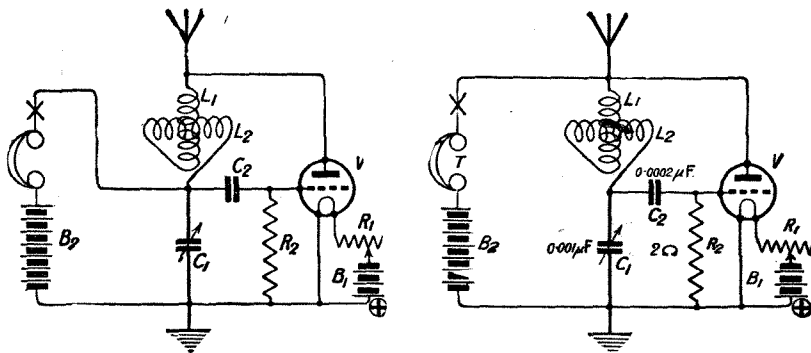

Figs. 3 and 4.—The "May" and "Albright" circuits.

with internally wound stator, re-wound with about 46 turns of No. 26 D.C.C. each, series variable condenser of .0007 (nominal .001)  $\mu\text{F}$ , Marconi-Osram D.E.R. run off two Hellesen dry cells with 30 volts on the plate, .0002  $\mu\text{F}$  grid condenser of Grafton Electric Co.'s make, and Dubilier 2 megohm leak to L.T. plus, on a fairly good P.M.G. double 40 foot. aerial, a transmission from Birmingham outside of regular broadcast hours, came in (in London) exceedingly easily and clearly in daylight with No. 4, the moment the wave-meter used to tune-in was switched off; and searching was found to be delightfully easy, once the knack of simultaneous control of variometer and condenser had been acquired. The circuit could be readily adjusted to a perfectly stable condition, just as near (in reason) to the oscillating point one desired, and overlap could also be banished by slight adjustment of the H.T.

The point of the double simultaneous adjustment is that the reaction varies with the proportion of inductance and capacity in the tuned circuit; so that it can be "tuned" and at the same time be as far from the oscillating point as desired. With the equipment given the range was from 300 to about 550 metres.

Making now the slight change to No. 3, the only difference noticed was a diminution of the available range of ready oscillation: it refused to oscillate below 350

meters now, and the adjustments were slightly different. Evidently there was no sort of advantage in this change.

Reverting to No. 2, the usual rather tricky adjustment and more limited range of available oscillation zones were immediately noticed; but no difference in signals within the available zone, precisely as expected.

It must be particularly noted that in every case, with English type of equipment, a radio-choke (say No. 200 Igranic coil or similar moderately-large inductance) must be interposed between anode and phone circuit. (Point X in diagrams.)

Accordingly, circuit No. 4 can be recommended for practical use outside of broadcast hours, and involves no particular difficulties nor special type of apparatus; it must be remembered, though, that it is easy to produce much interference with immediate neighbours, so that although it will give some measure of loud-speaking if skilfully handled on loud stations at unusual distances, it should not be attempted by the inexperienced, nor by those who do not aspire to a wave-meter.

A modified form of the Albright version, over which much ink has been spilt in recent American Radio literature—accompanied by the usual sensational claims as to signal-strength obtainable—is that indicated in the last figure.

In this the American circuit

diagram has been translated into terms of English components, as actually tried out by the writer, viz., with hard R valve and an Igranic vario-coupler for tuning unit. The original version is suited to the soft type of detector "tubes" requiring small plate voltage, and that narrowly regulated; so that it shows both potentiometer control of the H.T. and variable grid-leak, neither of which proved to be necessary with the equipment mentioned.

It will be seen that the main point of difference is that there is a tuned "acceptor" circuit loose-coupled to the A.T.I. after the manner of the Cockaday circuit (W.W. vol. 2, No. 16, p. 569): this is actually the rotor of the vario-coupler, tuned by a .0002  $\mu\text{F}$  variable condenser. The primary (stator) of the vario-coupler is roughly tapped, fine tuning being by the series .0005  $\mu\text{F}$  condenser and by varying the coupling.

The mode of operation is thus: the circuit is approximately tuned by adjustment of the tapped primary and series condenser. In general it will now be found to be oscillating violently. The acceptor circuit is then brought into action. By loosely coupling this with the A.T.I. and careful tuning, it absorbs so much energy from the main circuit that it stops the oscillations. Now by a series of fine adjustments of A.T.C., degree of coupling, acceptor-circuit condenser, tapped H.T. (and in the

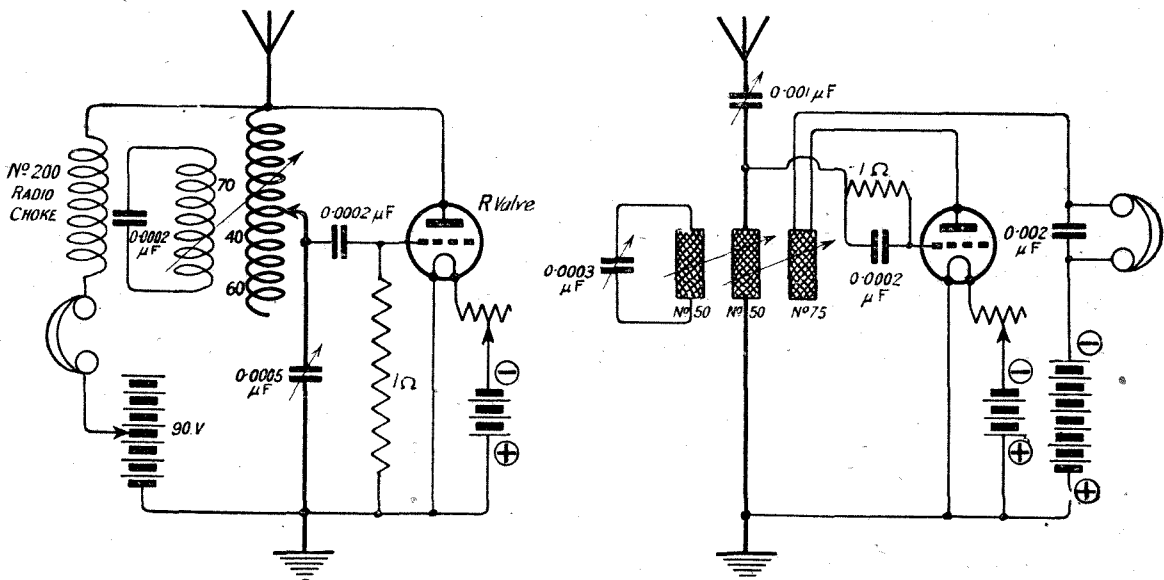

Fig. 5. A "Hairtrigger" circuit in two forms.

original American circuit of grid-leak and potentiometer), the receiver merrily oscillating and heterodyning everything in sight meanwhile, the circuit is juggled into a condition in which with the least possible coupling of the trap circuit it is just not oscillating, in spite of the powerful electrostatic reaction operating continuously.

A hair's-breadth disturbance will now push it over into violent oscillation.

The effect is best observed in a sensitive milliammeter inserted in the plate circuit. When in the most sensitive condition, the approach of a hand to a tuning knob will send the ammeter needle quivering over two- or three-tenths of a ma.; while a moderate Morse signal will set the needle into violent oscillations over half a milliampere. The signal-strength is, of course, proportionate. C.W. Morse does not come in particularly well in the phones, as the fine tuning necessary brings one into the silent zone. It is heard as a succession of thuds, the milliammeter needle quivering the while. One can understand that an observer getting this kind of effect for the first time might feel inclined to exaggerate his sensations a little when reporting on it.

Actually, of course, we have a trigger effect; the valve is just held down from oscillating when no signals are received by the damping of the loose-coupled trap circuit; received signals set it into oscillation at least for a moment, with resulting great change in the mean plate current.

The effect can be readily studied on the equivalent, more conventional type of reaction circuit represented in the diagram. A three-coil tuner holds a No. 50 in the centre, as A.T.I., with a .001  $\mu$ F tuning condenser in series with it. On one side is the usual No. 75 reaction coil; on the other the trap coil, a No. 50, with a .0003 tuning condenser. The circuit is tuned as usual to some signal, then made just to oscillate. The trap coil is then swung up to, say, 45 degrees, and tuned, so as to stop the oscillations. Then the reaction coil is swung up perhaps to within half an inch of the A.T.I., and the circuit retuned. By careful tuning and gradual withdrawing of the trap coil, the sensitive point can be found. Then signals will be found to come in, e.g., 50 per cent.

stronger than before and without the harshness characteristic of an ordinary critically-tuned reaction circuit. But this point is extremely elusive; maybe half an hour will be expended in finding it, so that continuous signals are required.

On actual trial of the variocoupler Albright version, certainly louder signals were obtained than on a conventional circuit after painstaking and minute adjustment of all the variables; so that in a distant suburb of London the announcer's "Hallo!" from 2 LO gave a swing of 50 microamperes in the plate meter on the single-valve receiver with a P.M.G. aerial. The band music came in at moderate strength on the loud-speaker, noticeably louder than customary on a single-valve circuit of real efficiency at that distance. The Savoy Orphean's drummer modulated some 25 microamperes plate current, for example. After London closed down, and after some quick work with a wavemeter and the four fine adjustments, a special late transmission came through very audibly on the loud-speaker from Glasgow.

The technical staff of the Radio Press do not recommend this particular circuit for amateur reception of broadcasting.

A GIFT FOR THE DEAF.

Mr. Geoffrey E. Duveen, whose name has figured so much of late in the press, as the donor of £25,000 to aid the deaf, is chairman of Messrs. Burndept Ltd., the wireless apparatus manufacturers.

Mr. Duveen has made this gift of £10,000 to London University to found a Chair of Otology, and the further £15,000 to equip a thoroughly up-to-date wing of the Royal Ear Hospital, in memory of his father, the late Mr. Henry J. Duveen, who was one of the Founders of the famous Art firm of Duveen Bros., of London, Paris and New York.

Mr. Duveen is himself the owner of a transmitting set installed at his London residence.

FROM A READER.

To the Editor MODERN WIRELESS.

DEAR SIR,—With reference to the August issue of MODERN WIRELESS and the article therein on "Adding a High-Frequency Stage to the S.T. 100"—I beg to send you particulars of the results I have achieved with the circuit shown in Fig. 4 of that article.

I substituted coils and condensers for the aerial-tuning and second plate variometers, and used a Radio Instruments Anode Reactance in the plate circuit of the first valve. I found that the circuit was not very selective with a single aerial circuit, so I altered it to a loose coupler, retaining the L.T. connection to earth. The grid leak was found to be unnecessary, and was omitted.

With these alterations the circuit has given very good results. Using 45 volts H.T., London is beautifully loud and clear on the loud-speaker, and Aberdeen, Glasgow, Manchester, Birmingham and The Hague have all been received comfortably on the phones. The loose coupler enables me to cut London right out—this is at a distance of nine miles.

I have not yet tried for the remaining B.B.C. Stations or Paris, but I have no doubt as to the result when I do.

I notice that in the text of the article referred to a reference is made to the "fairly large bridging condenser across the transformer secondary" (see last paragraph but two). This condenser is not shown in the circuit diagram, and although I have tried various values I have found that a condenser so connected paralyses the circuit.

In my opinion the circuit is far and away the best I have tried, both for range and volume. With regard to the range, it beats the S.T. 100 hollow, and although it surrenders a certain amount of volume to that circuit, there is plenty left for loud-speaker work. It is quite as stable and as easy to operate as the S.T. 100.

With congratulations on your two fine papers.

Yours faithfully,  
Beckenham. W. R. H.

# SWITCHES IN WIRELESS CIRCUITS

By OSWALD J. RANKIN.

*This article describes the use and connections of the most usual types of switches employed in receiving circuits.*

**B**ROADLY SPEAKING, what the tap is to the water pipe, the switch is to the electrical circuit. By means of the water tap we can control the flow of water through the pipe; similarly by means of a switch we can control the flow of electric current through a wire. Strictly speaking we should say *over* the wire, and in this sense "control" will mean either one of the two operations—on or off.

Switches may be regarded as

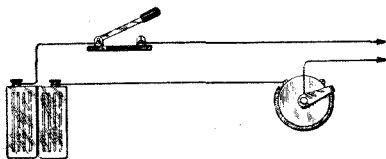

Fig. 1. A single-pole switch.

mechanical devices provided purely for the sake of convenience. Instead of transferring a connecting wire from one point to another we simply connect the ends of the wires to contacts which are brought in or out of service by means of a movable arm or arms also connected in circuit.

A very simple example of this is shown in fig. 1, where a S.P.S.T. (single-pole single-throw or "one way") switch is inserted in series with one of the accumulator leads

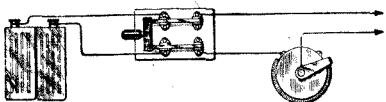

Fig. 2. A double-pole switch.

leading to the valve filament. Inserting in series means cutting the lead and joining the ends to the switch contacts, one to the arm and the other to the clip as shown. All switches are connected in series since they represent openings in the circuit which may be closed at will. The same remarks apply

to filament rheostats, where the amount of resistance may be varied at will. A D.P.S.T. (double-pole single-throw) switch as shown in fig. 2 may be used in place of the one just described. This has the advantage of more completely disconnecting the circuit from the accumulator or other source of supply.

Fig. 3 shows a S.P.D.T. (single-pole double-throw, or "two way") switch employed as a convenient device for changing over the aerial to earth when not in use. The aerial lead-in is connected to the centre clips to which is hinged the switch arm, and the right hand clips are connected to the aerial terminal of receiver. The earth lead from receiver is in contact with the left hand clips and earth, so that when the switch arm is thrown over to the right the circuit is closed ready for use, and when thrown over to

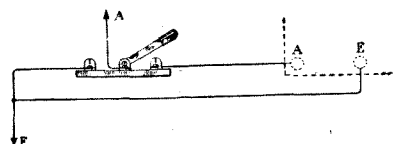

Fig. 3. A single-pole double-throw switch.

the left the aerial is disconnected from the receiver and is making direct contact with earth. This method of "earthing the aerial" is very popular and quite efficient, although many prefer the more complete arrangement afforded by the D.P.D.T. (double-pole double-throw) switch shown in fig. 4. The two pairs of clips on the left are bridged or "shorted" with a fairly stout piece of copper wire X. When the switch arms are in the position shown the receiving circuit is closed, and when thrown over to the left the receiver is entirely cut off from the aerial which is now in perfect contact with earth. This

type of switch is essentially a change-over device and may be used for a variety of purposes.

With the centre clips connected to the valve filament circuit, and an accumulator connected to each pair of end clips, it will be useful for quickly changing over the accumulators should one suddenly

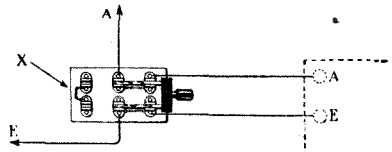

Fig. 4. A double-pole double-throw switch.

fail during an interesting broadcast programme. Another example of the usefulness of this type of switch is indicated in fig. 5, where it is shown connected in an aerial circuit for the purpose of switching the aerial tuning condenser either in series or parallel with the tuning inductance. When the switch arms are in the position shown, the condenser is in parallel, and when thrown over to the opposite side it is in series.

These connections often puzzle the beginner and it is hoped that they will be easily understood from the diagram and the following

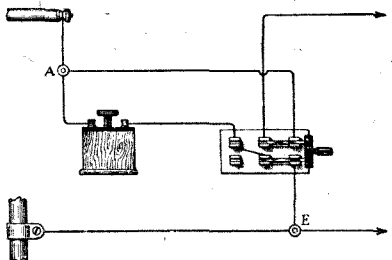

Fig. 5. Another use for a D.P.D.T. switch.

explanation. Counting from left to right at the top, we will number the clips 1, 2, and 3, and from



left to right at the bottom row, 4, 5, and 6. One side of the condenser is connected to the aerial terminal, and the other side to clip No. 1. Clip No. 2 leads direct to the tuning coil, and No. 3 is

number of studs and made to serve the same purpose as a multiple switch. It is sometimes provided with two arms linked together to bridge alternate studs, to act as a change-over switch.

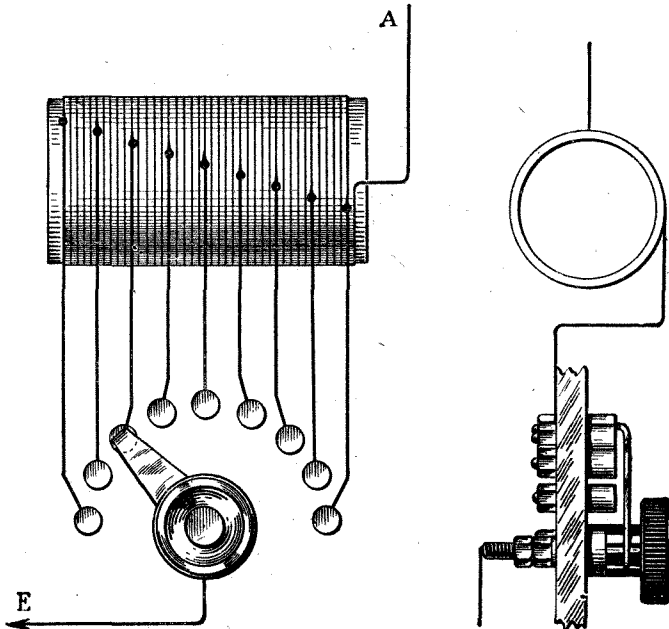

Fig. 6. A rotary tapping switch.

connected to the aerial terminal. No. 4 is left disconnected. No. 5 is connected to No. 1, and No. 6 goes to the earth terminal E, to which of course is also attached the other lead from the tuning circuit.

Fig. 6 shows the multi-point or multiple switch which comprises a series of contact studs and a revolving switch arm. This is used for a great many purposes and there is little doubt that it is the type of switch most common in the wireless world. It is here shown connected up to tappings of a tuning coil for the purpose of varying the amount of inductance.

Fig. 7 shows another type of S.P.S.T. switch, which is connected in series with one of the battery leads. The arm and two studs are mounted on a flat piece of insulating material usually provided with two terminals, one of which is in contact with the arm and the other with one of the studs as indicated by the dotted lines. It will be seen that by moving the arm over to the right hand stud the broken lead is joined, thus closing the circuit. This simple device may be provided with any

Fig. 8 shows a very simple cut-out employing a switch arm and two studs, and fig. 9 is a two-pin plug and socket which is sometimes used in place of a D.P.S.T. switch. The positive and negative circuit leads are joined to the contacts of the socket and a length of twin flexible wire is attached at one end to the pins in the plug and at the

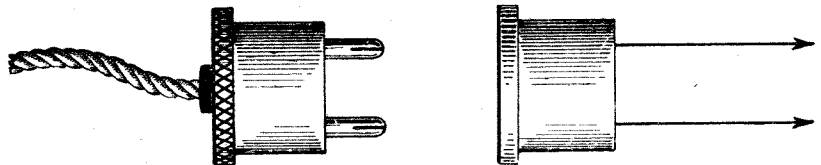

Fig. 9. A plug and socket connector.

other end to any piece of apparatus it is desired to bring into circuit. When the plug is pushed into the socket the circuit is closed. This is a very useful little fitting and an example of its adoption is given in fig. 10, where four sockets are connected in parallel with the telephone circuit of the receiver, so that one, two, or three pairs of 'phones and a loud speaker may be plugged in or out as desired.

The advantage of such an arrangement will be obvious. Any number of plugs and sockets may be arranged in this way, and should it be desired to connect them in series it will of course be necessary to "short" the sockets not in use. Now, if we connect the socket in

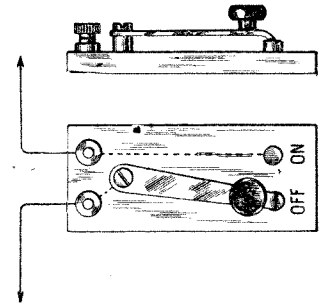

Fig. 7. A simple on and off switch.

series with a circuit lead, as shown in fig. 11, and short circuit the two pins by a piece of wire, we convert it into a simple form of key switch.

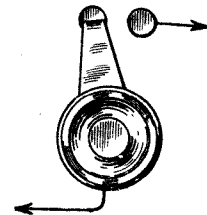

Fig. 8. Another on and off switch.

It will be seen that by placing the plug in the socket the circuit is closed.

A very simple example of this

is shown in fig. 12. Here is a key switch easily made from two contact studs and a short piece of brass or copper wire. The wire is bent as shown and made to engage two holes drilled in the contact studs. One of the battery leads are cut and the ends are joined one to each stud. By simply plugging in the wire bridge the lead is re-joined and the circuit closed. This "key" may conveniently be carried

in the operator's pocket so as to be accessible at any time.

Fig. 13 shows a plug and jack employed in place of a D.P.S.T. switch. There is an infinite variety of these and space will not permit

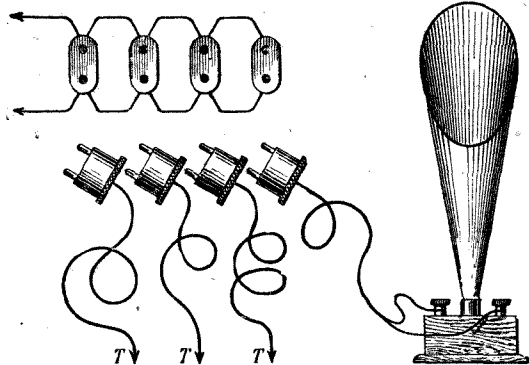

Fig. 10. Plug and socket switching for phones and loud speaker.

bridge pieces, which we will call clips, the narrow one on the extreme right being of the same width as the stationary clips, and connected to the earth lead. When the switch is in the position shown the entire winding is in circuit. By making an adjustment we switch

the loud speaker when the necessary adjustments have been made. This is accomplished by means of a simple key switch connected as shown in the diagram. The arm is in the "off" position, when both loud speaker and 'phone circuits are open. When switched over to the right the small ebonite roller will press the two left hand

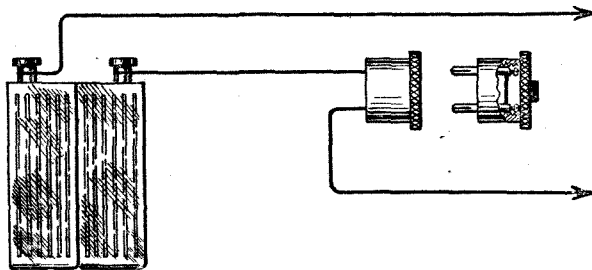

Fig. 11. A simple circuit-breaker.

of description of them all. They are used as convenient plug-in switching devices for breaking or closing a circuit, and like most types of switches some are more complicated than others.

A radial dead-end switch is shown in fig. 14. This is used to eliminate dead-end effects caused by an excess of winding on the tuning inductance over the approximate amount necessary for any desired wave-length. At first this may appear somewhat complicated, but in reality it is extremely simple. The arrangement of the coil must not be confused with that of the tapped coil where the tappings are taken off from a continuous winding. In this case the coil comprises a series of separate windings with the ends connected to the narrow switch contacts

over clip No.5 to G, and by so doing No.1 has passed out of circuit, No.2 bridges A and B, No.3 C and D, and No.4 E and F. The whole winding is now in circuit

clips together thus closing the telephone circuit, and when switched over to the left the roller moves across to the right hand clips, closes the loud speaker circuit,

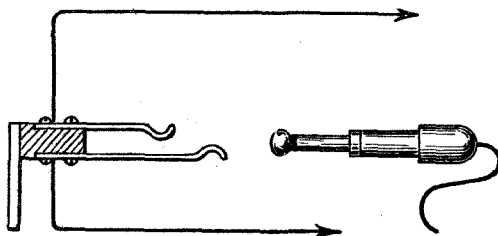

Fig. 13. Plug and jack connections.

with the exception of the last coil on the right. By making another adjustment to the left we also cut out the second coil from the right, and so on. This is a switch of great utility, but unfortunately its construction is a job seldom tackled by the beginner owing to the usual conventional diagrammatic impressions having a tendency to frighten him off the subject. If necessary the ebonite disc may carry any number of clips providing they are not extended beyond half the circumference.

and at the same time cuts out the telephone circuit. Like all other

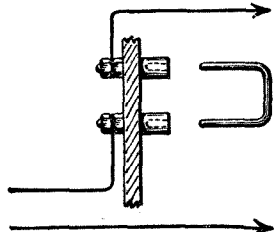

Fig. 12. A "key" circuit-breaker.

mounted in radial formation on a square ebonite base. These connections are clearly shown in the diagram. A disc of ebonite is made to revolve on the base and is fitted with metal contacts or

Finally we have the key switch, shown in fig. 15, which is indeed a very neat little contrivance particularly suitable for mounting on panels where space is limited. When using a loud speaker it is usually better to tune in with the headphones and switch over to

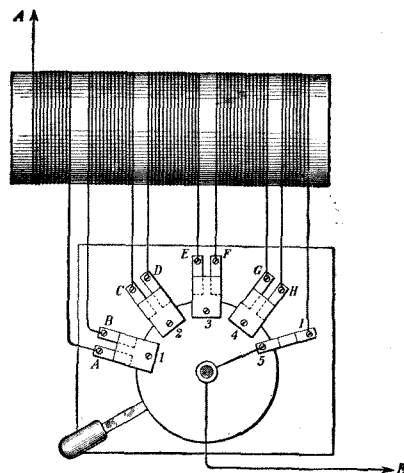

Fig. 14. A dead-end switch.

switches, these vary in design and use, and although they are essen-

mented where an enthusiast takes a pride in the appearance of his

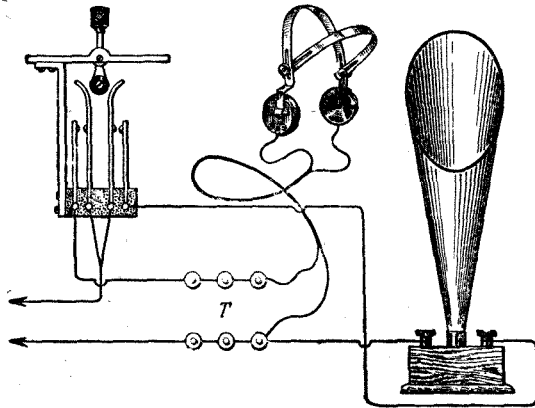

Fig. 15. The connections of a Dewar switch.

tially more complicated than most types, they are always to be recom-

apparatus. They are now marketed in several forms.

SOME WECOVALVE TIPS.

WHEN used even with a moderate-sized dry cell, designed for the purpose of ringing household electric bells, Weco valves give excellent results. The cell when new has a potential that is considerably too much for them and nearly the whole of a 6-ohm resistance has to be thrown into action in order that the filament shall not be burning too brightly. But after a certain amount of use the potential begins to fall off owing to the increasing

internal resistance of the cell. It can be used by itself until this potential has fallen away to about .9 of a volt. Even then it is by no means done. Two cells that have seen better days can be wired together in series and used until their combined potential drops to about 1.4 volt. There is only one slight drawback which manifests itself. The current from old cells, and even from new ones if they are hard worked, is apt to be a little bit irregular. When in action the cell polarises owing to the formation of hydrogen bubbles round the positive element. These are got rid of by the manganese dioxide depolariser, but the process of depolarisation may lag a little behind that of polarisation, hence the current becomes slightly uneven and the valve may be on the noisy side.

This may be cured to a very great extent by the method shown in Fig. 1. A paper dielectric condenser with a capacity of two microfarads or even more is shunted across the dry cell where it acts as a stabiliser for the output. A still better arrangement is shown in Fig. 2, where the same two-microfarad condenser is kept permanently

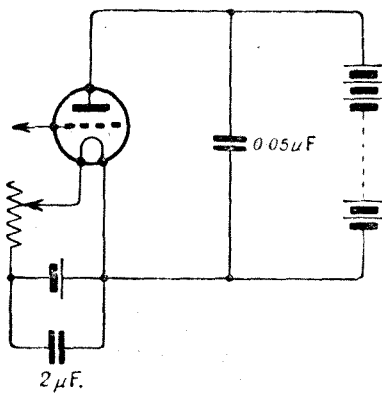

Fig. 1. A shunt across the dry cell.

wired across both high and low-tension batteries.

It will be found that the Weco valve, especially when used as a combined detector-amplifier on a single valve set, is very ticklish as regards its anode voltage. Fig. 3 shows a simple but very effective way of arranging matters so that it can be adjusted to a nicety. In series with the filament cell is placed a pocket flashlamp battery shunted by potentiometer of high resistance whose slider is connected to the

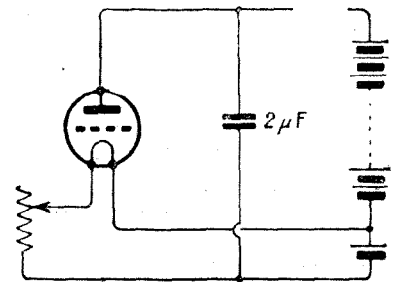

Fig. 2. An improved arrangement.

negative of the high-tension battery. It will be seen that by moving the slider, any fraction of the flashlamp battery's potential from zero to 4½ volts can be added in series with the high-tension battery. The exact plate potential for the best results can thus be found without any great difficulty.

If the flashlamp battery is to have a long life two points must be observed. In the first place the potentiometer must be disconnected either by unwiring it or by means of a simple two-way switch whenever the set is not in use, for current flows continuously so long as the

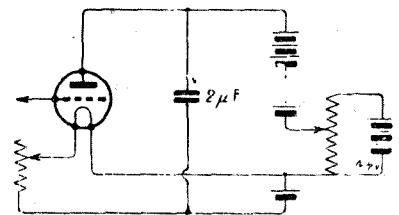

Fig. 3. A critical control plate.

potentiometer is in action. Secondly the potentiometer should have a total resistance of at least 600 ohms, for flashlamp cells cannot supply more than a few milliamperes for any length of time without becoming noisy.

R. W. H.

# FROM TWO TO SIX VOLTS OFF THE SAME ACCUMULATOR

Hints for Dull Emitters.

By R. W. HALLOWS, M.A., Staff Editor.

THERE are some who prophesy freely that the 6-volt accumulator now in common use will soon become a back number so far as wireless is concerned. Dull emitter valves are certainly becoming very efficient, and their demands upon the accumulator are very small indeed. It is likely that for broadcast reception they will supersede "high temperature" valves as completely in this country as they have done in America; but the wireless experimenter will not yet find them stable enough or sufficiently even in design for work that demands absolute uniformity in the valves that go to make up either the high frequency or the low frequency part of his set. Nor on the whole are dull emitters quite so efficient as valves of the old type.

The experimenter will therefore keep his 6-volt accumulator so that he may be able to use his old friends, but at some time he will want to try out the various types of low temperature valves and to investigate their possibilities. The problem is how to use one and the same battery for valves requiring the best part of an ampere at 5 volts and those which need only .25 ampere at a little over one volt.

The solution adopted by the writer was to fit switches arranged as shown in Fig. 1. It will be seen that in diagram A the two volt cells X, Y and Z are in series; the output is therefore 6 volts. At B one switch has been changed over with the result that Y and Z are now in parallel with X in series with the combination. The output on the terminals is now 4 volts. But when both switches have been turned over as at C all the cells are in parallel with a terminal output of 2 volts.

This is the most useful arrangement, for it means that with the sole exception of the "Wecovalve" any type of valve can be used upon the panels of the set with the ordinary rheostat. For the Weco-

valve it is necessary to provide a small extra resistance of about 7 ohms, which is placed in series with the rheostat. This can be done by winding 70 turns of No. 26 enamelled Eureka resistance wire upon a former made of a 2-in. length of ebonite rod  $\frac{1}{2}$  in. in diameter.

The 4-volt combination (B) is

and throws in most of the resistance of the rheostat.

If three separate 2-volt cells of like capacity are used wiring is of course simplicity itself, but if, as is usually the case, the cases of the cells are fixed together and are connected positive to negative by means of lead strips then the connecting bars must be cut through

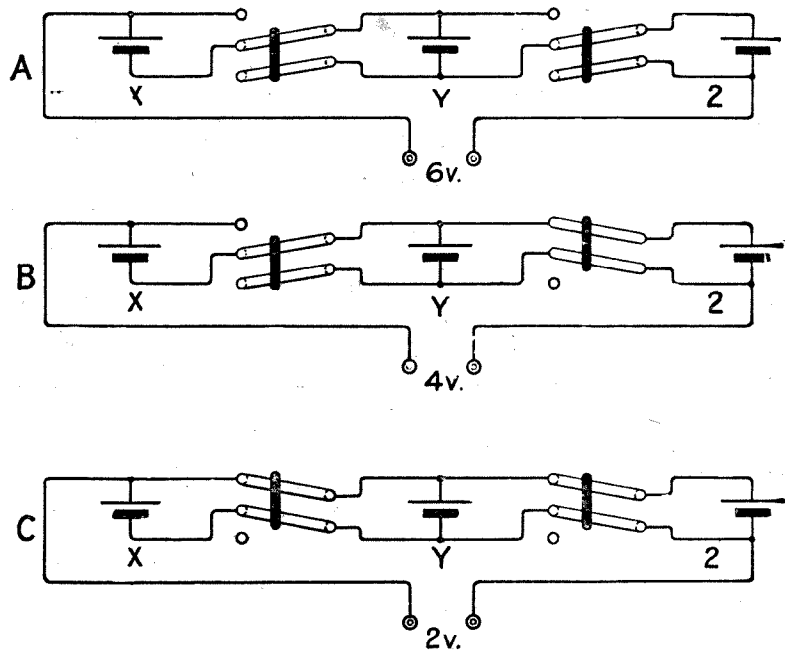

Fig. 1.—The switching arrangements.

suitable for the M.O. Valve Company's D.E.Q. and D.E.R., and for the American U.V. 199, all of which require a filament E.M.F. of 3 volts. Combination (C) is just right when the batteries are fully charged and the L.T. leads are not unduly long for the M.O. D.E.R., the Mullard L.F. Ora and the Ediswan A.R.D.E., all of which need round about 1.8 volts. Sometimes, however, one comes across a valve of one of these latter types which needs fully 2 volts; in this case one simply switches over to combination B

with a hacksaw and the ends fitted with terminals as seen in Fig. 2.

As we are dealing with very low voltages there is no reason why the switches should not be mounted directly on to the teak crate that holds the accumulator. Fig. 3 shows how the switch is made. Two strips of springy brass  $1\frac{1}{8}$  in. in length and  $\frac{1}{16}$  in. wide are cut out with tin shears. They are connected by a bridge made from a piece of  $\frac{1}{8}$  in. ebonite, the distance between the arms being exactly  $\frac{1}{2}$  in. The screws which secure the bridge to the arms should be cut

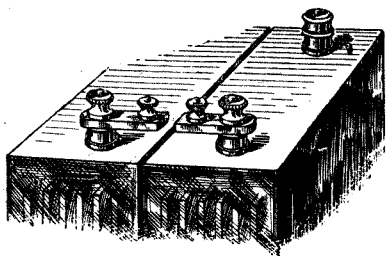

Fig. 2.—The altered busbar.

off short and slightly riveted over on the under side so that they cannot work loose.

The arms are mounted as shown in Fig. 4, the pivots being made from two small 4 B.A. terminals provided with spring washers. If necessary flat washers may be inserted under the arms to adjust

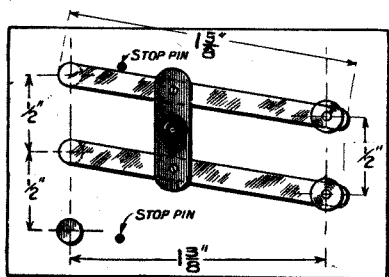

Fig. 3.—Details of switch.

them exactly to the height that gives good firm contact with the studs. A nut and a lock nut may be used instead of the milled headed terminal top if preferred.

Great care must be taken so to space the studs that the arms cannot make contact with two of them at once, otherwise there will be a short circuit. For this reason

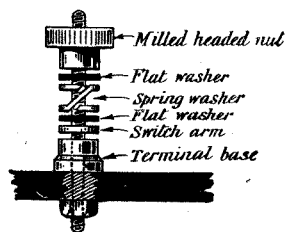

Fig. 4.—Arm mounting.

they are shown 1/2 in. apart in the drawing. Were we to simply leave it at that the action of the switch would be very far from smooth, for the arms would drop into the hollows between the studs when moved. For this reason it is better to mount the studs almost flush with the surface on a strip of ebonite or ordinary hard wood as

shown in Fig. 5. The edges of the studs are slightly bevelled off with a fine file so that the switch arms may slide easily up on to them after moving over the surface of the wood. As stop pins are pro-

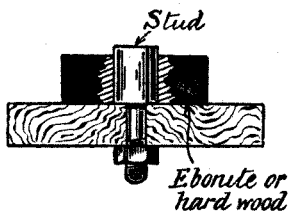

Fig. 5.—Stud mounting.

vided at either side there is no fear of failing to make proper contact even if the switches are moved by a hand groping under the bench.

One should always examine the studs carefully before using them. Sometimes a little point of metal is left in the centre of the top of each by the lathe tool. This must be filed away so that the surface is absolutely flat, for if there is any projection of this kind contact between arm and stud must always be very poor.

### TERMINAL ADAPTERS FOR WIRE CONNECTIONS

THE wires used in connecting up apparatus can be kept very neat and free from stray ends by finishing them off with terminal adapters, which may be readily and cheaply constructed as follows.

From a piece of copper sheet about 1/16 in. in thickness cut several oblong pieces each measuring 1 in. by 1/2 in. These pieces should then be cut as shown in Fig. 1 by means of the dotted lines, after which the two sides of A-B should be curled into a small circle, this operation being easily performed with a small pair of pliers.

The ends of the leads to be used should next be carefully stripped of the insulating material up to about 1/2 in., this bared portion being inserted in the terminal adapter

end curled portion A-B as shown in Fig. 2, after which the curled piece should be tightened up with the pliers, and preferably soldered down

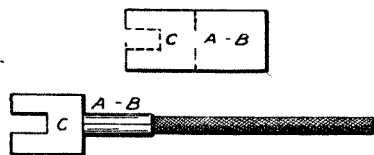

Figs. 1 and 2.

the seam to ensure perfect contact being made. The slotted portion C will then facilitate the connection to any instrument terminal.

D. F. U.

### FROM A BEGINNER.

DEAR SIR.—Just a few lines from a beginner in wireless.

I had lent me some time ago the first number of MODERN WIRELESS.

As a start, I thought I would make the home-made set described there, with cardboard formers.

The whole thing did not occupy more than a few hours of my spare time, and I did not expect any great result, being nearly forty miles from Glasgow, the nearest broadcasting station.

Judge of my astonishment when, with a clothes-prop to upper window aerial (about 7 ft. high) I heard perfectly clearly although not too loudly a relayed London concert.

With a higher aerial (about 15 ft.) and 100 ft. single copper wire, I can hear through two sets of headphones quite well. A friend who immediately copied my set presumably has a better situation, as, with clothes-prop aerial, he can hear quite well with three pairs.

We use "Hertzite" with copper and gold cat-whiskers respectively.

In view of ten to twenty miles being considered the limit for crystal, are these results not rather remarkable?

Presumably direction of aerial has some effect; both points E. and W. (Glasgow is S.W.)

We are now, needless to say, enthusiastic readers of "M. W."

Yours truly,

NOVICE.

Rcsyth.

[The results obtained are certainly very good.—Ed.]

## SILENCING NOISY AMPLIFIERS

By C. R. A. PAGE, A.M.I.R.E.

*Nothing is more annoying than to find that the additional strength given by an amplifier is accompanied by distressing noises which quite spoil the reproduction. In this article the author gives many useful notes on how to remedy the trouble.*

### A Din that Worries

**M**ANY possessors of a receiving set experience a worrying and most decidedly unpleasant "din" in their telephones and loud-speakers. This is more especially the case where the valves used exceed two in number. Very often, however, the noises, which are many and varied, can be minimised, if not entirely eliminated, by proper care and periodical inspection of the apparatus.

### Faults in H.T. Batteries

The cause of "sizzling" and "crackling" can generally be traced to the high-tension battery or the telephones. If the former is of the solid block type, consisting of a number of small dry cells placed in a container and filled in with paraffin wax, it is rather a difficult matter to examine each cell separately. Any showing signs of bubbling, which is usually apparent through the wax, should have the wax scraped away and the terminals shorted.

### How to Test H.T.

A high-tension battery composed of single cells or of flash-lamp batteries can be easily tested cell by cell, and all showing a low-voltage reading should be either shorted or removed. In every case each should be well insulated from its neighbour and from the container.

Assuming that connections, both internally and externally, of the battery are all well made, and that defective cells are out of circuit, attention should be turned to the telephones.

### Look to your 'Phones

If these are of high-resistance, connected directly in the plate circuit, they may be regarded as a very probable cause of "crackling," especially if they have been in use for a considerable period. The insulation is very thin, and after being subjected to the high-plate potentials for some time it is very likely to break down, and current leakage occurs between adjacent layers and turns, and possibly through to the casing of the receivers.

There is no really practicable method of testing them. The best way is to borrow a pair that are known to give silent working and to try them on the receiver. If the noise is at once removed it is obvious that a replacement is necessary. The same fault may, of course, occur with a loud-speaker, a telephone transformer, or with a low-resistance pair, but it is not so likely, as the windings are much more robust. In those pairs fitted with protective gaps, intermittent shorting may be taking place across them, due to an accumulation of dust or moisture at the points.

### Transformer Troubles

Another source of trouble lies in the low-frequency transformers. It is bad policy to purchase cheap, unknown makes. Apart from the fact that very often the windings consist of far too few a number of turns, the insulation between layers and between primary and secondary is usually insufficient to stand the strain imposed upon it by the potentials applied under working conditions. Insulation tests should be made between both windings and from windings to frame.

Even the best of amplifiers sometimes suffer from a certain amount of noisiness, this being due to eddy currents and other factors that arise. This increases with further stages of note magnification, and sounds at audible frequency are readily amplified, sometimes to such an extent that signals and speech become impossible.

### Enclosed Transformers

Enclosing the transformers in a copper or iron case, and/or lining the box holding the apparatus with tin-foil and taking a connection to earth often lessens interference caused by induction from electric lighting, tramway systems, nearby motors and dynamos, etc. Favourable results are also often obtained by joining all the iron cores together and making a common connection to the positive side of the plate battery.

Sometimes "crackling" is the result of



condenser leakage, particularly through those shunted across the high-tension battery, the telephones, or the low-frequency transformers. These can be tested for shorting by connecting them in series with a lighting bulb and placing across the mains or some other high-voltage supply.

"Howling" and "singing," apart from that produced by too tight reaction coupling, are reduced by decreasing filament current (though signals may also weaken somewhat), by keeping all leads as far apart as possible, and by reversing the connections to one of the intervalve transformer primary windings.

All leads, both those inside the instrument and those used to connect up the various accessories, should be quite rigid, and all terminal connections and joints well made. Solder should be used wherever possible, at

the same time taking care that a good joint is made electrically. Unless both surfaces are thoroughly cleaned before the solder is applied, although to outward appearances a good joint has been made, actually a very high resistance path may have been formed. Too much flux also should be avoided, or the same result may occur.

Changing around the valves may improve matters, as the slight difference in characteristics or non-rigidity of the electrodes may produce microphonic sounds.

The set as a whole should be as far removed from lighting mains and other power supplies as possible; and where aerial, earth and other leads are unavoidably brought close to conductors carrying varying currents, they should be arranged to cross them at right angles.

CRYSTAL NOTES  
FOR THE BEGINNER

Some quite excellent crystal detector stands are mounted on very inferior bases, made either of wood or one of the nasty black compositions supposed to be ebonite. Good ebonite is, of course, one of the finest insulators known, but unfortunately the buyer cannot always be protected against substitutes, and much of the ebonite now sold has very little rubber in its composition. If you have doubts as to the quality of the base of your detector, you will find it advantageous to demount it and fit it up again on a piece of really good ebonite. I should not be surprised if many readers find that they get nearly double the signal strength by this little change.

\* \* \*

When using several pairs of telephones together on a crystal receiver it is usually advantageous to connect them in series with one another. This is done by taking the connecting tips of the various pairs of telephones and joining them as follows. One tip on one pair of telephones should be connected to one of the telephone terminals, the other tip should be joined to one tip of the second pair of phones (this can be done by binding

the two tips together with a piece of bare wire) while the other tip of the second pair of telephones goes either to the remaining telephone terminal or, if further telephones are used, to one of the tips of the next pair, and so on, so as to form a chain of all the tips, the two extreme ends being connected to the telephone terminals of the set.

Use a Screw Adjustment Detector

One cannot use a crystal set for long without coming to the conclusion that the ordinary type of detector, with its sliding adjustment for the cat-whisker, is not satisfactory: one can scratch away at the surface of the crystal for minutes without succeeding in getting just that pressure upon the contact point which gives the best signals.

The obvious remedy is to make or buy a detector in which some sort of slow-motion screw is provided for advancing and withdrawing the contact-wire. Such a detector can be bought quite cheaply (a suitable pattern is retailed at 4s. 6d.), and will be found a great luxury after the ordinary pattern has exhausted your patience (and vocabulary?).

## THE CARE AND MAINTENANCE OF RADIO APPARATUS.

By R. L. ROPER.

*The reader will find in the following article some excellent advice relating to the care of wireless apparatus, a subject which is too often disregarded by the experimenter.*

**T**HIS is written chiefly for the help and guidance of the amateur who comes to wireless without a previous apprenticeship to a hobby which has made him familiar with the operation of electrical and mechanical apparatus.

More than almost all other types of apparatus, wireless will let you down most thoroughly when neglected or subjected to misuse. Yet one frequently finds experienced amateurs being let down, not through ignorance, but by neglecting to carry out some simple operation, or not acting upon some warning sign given by the set. As with most machinery and instruments used in the mechanical and electrical world, a breakdown seldom happens without warning. The misused or overburdened part gives some sign which is tantamount to saying, "Look here, I can't stick this much longer, or I'll bust"; and the man who disregards this, or is not sufficiently experienced to diagnose the symptoms, finds that it does "bust." So, if your set acts in a manner which is unusual in any respect, be sure that something is happening, or about to happen, which it is as well to prevent; and the immediate action to be taken is exactly as if you yourself had developed a peculiar pain somewhere "inside." It may be something simple, merely calling for home treatment, but if not diagnosed a consultant should be called in and the patient rested meanwhile.

### Soldering

It cannot be too strongly urged that acid should *not* be used. The rate at which corrosion takes place in fine copper wires, such as are used in flexible leads, is difficult to believe unless seen. If acid is used in soldering large connections or surfaces, it is recommended that the joint and its vicinity should be painted over with shellac varnish to exclude the atmosphere.

The best method is to clean all parts of a joint by scraping, or with sand-paper, and to

use resin as a flux; the resin will flow over the outside of the joint and act as an insulating agent. Do not take any chances with a doubtful connection which is going to be in an inaccessible position in your set; it will be almost certain to cause trouble later, and probably be extremely difficult to remedy without disturbing other components.

If you are not good at making soldered joints you should practise well before making joints intended to be permanent in your set. The expert achieves his object with the minimum of solder for the joint required, but it is a knack acquired by long usage. Remember, you cannot solder unless your iron is clean and hot, hot enough to heat the metal to be soldered and its adjacent parts; merely hot enough to melt solder is not sufficient, except perhaps for the smallest jobs.

### Dry Batteries

Dry batteries, generally speaking, are charged or more or less discharged, and when discharged rather more than less, they are useless. But the useful charge can be maintained a little longer, perhaps, if they are taken care of. In radio work they will usually be used for the H.T. voltage. If built up units with a wander plug are employed, and not used over the whole available range, change over the order of coupling occasionally so that the unemployed cells of the last unit, *i.e.*, the one in which the wander plug is used, may be utilised when it is the first unit.

When building up an H.T. unit from flash-lamp batteries they should be insulated one from the other, otherwise there is a distinct tendency to rapid discharge. This is best done by obtaining a cardboard box of the size required to take the batteries with an easy fit. Cover the bottom and the lid with paraffin wax, place the batteries in position, and pour more molten wax around and between them.

The batteries should not be connected together by means of a loop of wire around

adjoining terminals. They should be soldered, or an ample and firm contact made by some less haphazard means than the loop-of-wire method. The unit is completed by bringing out leads from the opposite terminal, fitting the cover, and tying round box and cover with string. It may be said that one of the main objects in building up these units from separate batteries is the simplicity with which discharged batteries may be substituted, and that the waxing in of the batteries and the soldering of the connections complicates this. All right, so it does; but it will save you many pence, probably shillings, in keeping your unit efficient longer than the loosely coupled up and uninsulated one would do, whilst the comparatively slight trouble will be worth while if you are of frugal temperament, or limited means. The only articles required to effect a replacement are soldering iron, hot knife, and the replacement battery. Run the joints of the terminals with the soldering iron, pass the heated knife around the battery to be removed, lift it out, insert the replacement, run some fresh wax around it by means of the heated knife, remake the two soldered terminal joints, and the job is complete.

Dry batteries should be disconnected by a switch, or otherwise, when not in use. Perhaps the greatest economy which may be practised with dry batteries is in the method of purchase. They should be the best, and new stock. To ensure the latter they should be purchased from a dealer whom you know to have a rapid turnover. Each one should be tested and be free from stains. Of course, they should not be subjected to damp.

The treatment of dry cells with sal-ammoniac and water is a messy and doubtful business, and the resultant battery not to be depended upon; so that, in case you endeavour to prolong their useful life by some such dodge, have a replacement ready. When in doubt about the polarity of dry cell contacts, attach leads to the contacts and dip the free ends of the wires into a glass of water with a little salt dissolved in it; the one which gives off the most bubbles is the negative.

#### Accumulators

The accumulators are an expensive item of equipment, and are also capable of giving considerable trouble if not taken care of, and if neglected or misused they will certainly be ruined. Probably the most general fault amongst amateurs with regard to their accumu-

lators is in providing those of inadequate capacity. Generally speaking, so long as the accumulator heats the filament of the valve, or valves, to a sufficient temperature, it is taken for granted that all is well. This does not necessarily follow, however; if the accumulator be a 6-volt one and the valve filaments will heat sufficiently at four volts, the accumulator can become 25 per cent. discharged before becoming ineffective, which is extremely bad for it.

An instrument rarely seen amongst an amateur's kit, but which should be present wherever accumulators are in use, is the hydrometer. A hydrometer is no more expensive than a cheap voltmeter, and a cheap voltmeter is worse than useless, because it will probably be inaccurate and therefore misleading. If a voltmeter is used to judge the condition of your accumulators, remember that the readings must be taken when they are discharging through the normal circuit. A much better way to determine this is by means of the hydrometer. In a fully charged battery the electrolyte should have a specific gravity of 1.25, and should never fall below 1.15 when the accumulator is practically exhausted. The level of the electrolyte should be kept just above the plates. Loss by evaporation should be made good by the addition of distilled water, to be purchased from a chemist; loss by spilling should be made good by adding fresh electrolyte, obtained by mixing pure brimstone sulphuric acid with distilled water to give a specific gravity of 1.25. The dilute acid of the correct specific gravity, 1.25, could be obtained ready mixed from a chemist, or the two obtained separately and mixed as required, provided a hydrometer is available.

Buy your acid and water from a chemist, and you will get it pure. If you obtain them elsewhere, be sure they *are* pure. Remember, *never add water to acid* when obtaining the dilute acid; great heat will be generated, the vessel probably break, and you might lose your eyesight. Mix acid with distilled water drop by drop, stirring meanwhile, and always in glass or earthenware vessels. If it is proposed to charge and maintain your own accumulators you are counselled to obtain the maker's instructions, or otherwise read up the subject.

It cannot be too strongly emphasised that any trouble taken to ensure that your accumulators are charged by a capable man will be amply repaid in added efficiency and increased life.



# A Sensational Development in Wireless Valves - the D.E.3

D.E.3. Valve  
0.06 Amperes.  
Filament volts 2.4-3 v  
Plate volts 30-80 v  
Price 30/- each

A real Dry Battery valve with a current consumption less than **ONE QUARTER** that of any other type of valve on the market.

## 0.06 Amperes

The D.E.3 valve embodies all the advantages and latest improvements in Dull Emitter Valve manufacture.

*NO ADAPTORS REQUIRED.*

Three ordinary dry cells in series will run one of these valves for 800 hours at a cost of less than half a farthing per hour.

# MARCONI VALVES

MADE AT THE OSRAM LAMP WORKS

*Sold by all leading Wireless Dealers, Electrical Contractors, Stores, etc.*

*Wholesale only:*

**THE GENERAL ELECTRIC CO., LTD.,** Magnet House, Kingsway, London, W.C.2.



# Leadership

**I**N every sphere of life or field of business, one man or one firm leaps to the front and secures the leadership.

With two periodicals to our credit — **Modern Wireless** (Published on the first of the month) and **Wireless Weekly** (published every Wednesday), together with an increasing number of Books, we can say, without fear of contradiction, that we are the largest publishing house in this country

solely devoted to the Wireless Industry.

Leadership, however, creates responsibilities. We realise ours, and appreciate that our duty to the ever increasing number of readers of **Modern Wireless** and **Wireless Weekly** lies in maintaining the high standard of quality prevailing at their inception.

---

**RADIO PRESS Ltd., Devereux Court, STRAND, W.C.2**

---

### Valves.

Always fit a valve to its holder with the filament resistance in the off or minimum position, and see that the H.T. battery is disconnected, by switch or otherwise; then heat the filament by gradual reduction of the resistance until the desired intensity has been obtained. A slight increase in signal strength may be gained by greater brilliance of the filament, but it will probably not stand up to the additional heat for long.

Over-heated valves may give considerable trouble by oscillating freely, and distortion of telephony will be an inevitable result of this fault. Don't buy different types of valves and expect them to work off common controls of filament and anode voltages—you wouldn't find a racehorse the same ration as a cart-horse—if it succeeds it is the exception. Different valves for different purposes are all right, but they must have separate controls.

### Variable Condensers

These instruments are easily affected by jolts and jars; the spindle may be put out of alignment, or the plates bent by a blow. They should accordingly be treated with care. Particles of dust or other foreign matter between the plates may be the cause of troublesome noises and should be excluded by enclosing the plates of the instrument in celluloid or glass.

### Tuning Coils

If of the home-made, hand or machine-wound type they should be dipped in good shellac varnish and baked as a preliminary protection, enabling them to be suitably mounted and handled with a minimum disturbance of the windings and damage to the insulation. Tuning coils should not be permitted to stray all over the operating bench amidst a collection of tools, head-phones and other impedimenta, otherwise the occasion may arise when you desire to hear your favourite station and find that the coil required has suffered from too close proximity to acid spilt from the accumulator, or contact with some hard and sharp tool.

It is suggested that they might be hung on a board provided with wooden pegs; if each peg is numbered with the coil number to be readily identifiable so much the better, and the ideal of "a place for everything, and everything in its place," will approach attainment when a rack is provided for the few necessary tools, and hooks or pegs placed in a convenient position for the head-phones.

### General Cleanliness

The need for this cannot be too strongly emphasised. Dust and foreign matter may cause trouble, and will certainly reduce the insulation of the ebonite when present between various terminals and fittings, and will provide a leakage path for currents of different potentials and polarity, resulting in reduction or even loss of signals. A soft brush is a handy tool for dusting over the set, the bristles or hair being capable of working in between valve legs, coil plugs, and similar fittings. Any acid spilt from the accumulators should be immediately mopped up, preferably with ammonia water.

### Log

A log is an extremely useful aid to successful operation. It is handy for reference as to dates and times of reception of certain signals, but its most useful purpose is for the notation of accurate adjustments when a tuning operation has been difficult, enabling one to obtain the same critical settings at a later date with a minimum of time and trouble.

### Aerial

The aerial is liable to be forgotten and allowed to take care of itself. Provided the fittings, etc., are good and the insulation ample, this may be all right, and should no external agency get to work, it may be free from trouble. It is, however, advisable to give the whole aerial system an occasional overhaul, not forgetting the earth.

The insulators need an occasional wash to remove the coating of grime which will eventually provide a leakage path to earth; a spot of paint on ironwork and varnish on spreaders will do no harm and minimise the effect of the weather. At the same time halyards and stays should be examined for chafes or other damage, and all connections inspected for soundness.

It is better to do this, say, every three months than to descend one gusty morning to be informed that a few pounds of pulley block, insulators, etc., have crashed through the conservatory and that the pots of prize tulips have joined in the calamity. Should you not have a conservatory, it would be equally annoying to be wakened by your neighbour across the back green with the news that his pet canary has suffered sudden decease on account of your aerial fixings and fittings having "earthed" through his kitchen window.





**A Low-Frequency Intervalve Transformer**

Messrs. Burne-Jones & Co. have submitted for test an inter-valve L.F. transformer (the Magnum) of compact design, measuring little over 2 in. square by 2 3/4 in. long. The instrument is attractively finished, is provided with terminals mounted on ebonite strips, and brass brackets for attaching behind a panel by four small screws.

On test, the insulation resistance was adequate, the primary winding showed medium impedance, and in actual reception of broadcast speech and music, good amplification was observed, together with an absence of parasitic noises.

**A Cat's Whisker**

A "Spearpoint Cat's Whisker" has been sent us for practical trial by Ernest Bastock. This is claimed to be made of a special alloy, with a hammer-hardened spear-point, particularly suitable for use with the synthetic galena type of crystal common to-day.

On actual trial it was found to give very good results, the coiled wire spring being apparently of just the right degree of springiness without being severe on the crystal, whilst with the sharp point the sensitive spots could be located with accuracy. There was no sign of falling off when used for lengthy periods without attention, even on exacting dual-amplification circuits.

The whisker-contact is the very heart of the most elaborate crystal-receiver; this spearpoint device can be confidently recommended

as far superior to many of those being sold indiscriminately in the radio-accessories stores at the moment.

**A Three-Valve B.B.C. Receiver**

Messrs. Bowyer-Lowe Co., Ltd., have submitted for trial a cabinet three-valve B.B.C. receiver of the sloping desk type, having the usual arrangement of H.F. detector and

L.F. valve. The valves are housed in a compartment with a hinged lid, but can be viewed through small windows. The wave-length control is by a tapped coil and parallel condenser, a tapped semi-aperiodic H.F. transformer providing the inter-valve coupling. Separate filament resistances are provided for each valve, the H.F. valve having in addition a "Vernier" filament adjustment, which was found to give fine reaction control. Variable reaction by swinging coil is provided on the H.F. transformer, and terminals are provided for supplying the three valves with different H.T. from a tapped battery, and also for grid-bias on the L.F. amplifying valve. All these terminals are housed in the valve compartment, none being visible from the outside except aerial, telephone, and earth—a good point in a family instrument. The wave-length range is from 150 to 1,200 metres; provision is made for plug-in loading coils up to some 4,000 metres.

There are seven controls in all; on trial on local broadcasting good loud-speaking, clear and free from distortion, was obtained with the greatest ease with 90 volts on the plate of the amplifying valves, R-valves, and grid bias. Of course, with an untuned semi-aperiodic H.F. transformer, the usual trouble of lack of selectivity (except with critical reaction-adjustment) was experienced, but by careful tuning with the aid of a wave-meter it was possible to get Birmingham, Newcastle and Glasgow nicely



The "Ultra" loud-speaker.

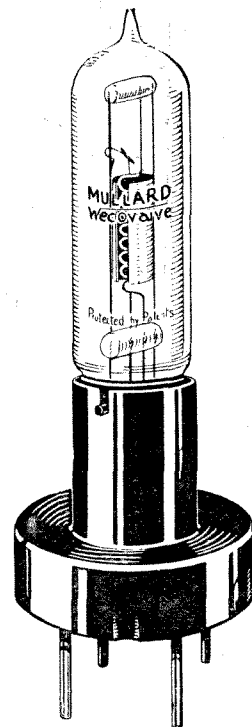

## Have YOU thought

of the saving you will be able to effect by means

## of the MULLARD WECOVALVE ?

THE MULLARD  
WECOVALVE

(Actual Size)

Price **30/-**

*If you are building your own set, see that you fit it with "Weco Valves."*

*If you already possess a valve set, "Weco Valves" will pay for themselves in a few weeks.*

¶ Under normal working conditions the filament will last for 4,000 hours.

¶ A Mullard Weco Valve requires only ONE dry cell to operate the filament, and even then a filament resistance is necessary. The life of a cell of ordinary size is several weeks.

¶ The filament is short, strong, and well supported, making breakage from mechanical shocks almost impossible.

¶ The Mullard Weco Valve is suitable for use in all cases where valves of the ORA and R type are now in use.

# Mullard

Obtainable from all Leading Electricians and Wireless Retailers.

Advt. The Mullard Radio Valve Co., Ltd., Balham, London, S.W.12.

(E.P.S.87)

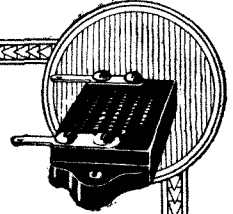
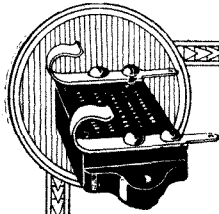

# Constructional Chats

By P. COURSEY, B.Sc.

No. 1.

## The Importance of Correct Condenser Design.

**M**ANY years of research and progress lie between the pioneer Leyden Jar and the Transmitting or Receiving Condenser of to-day.

It was early realised that the losses of energy in the glass or other dielectric of the ordinary type of Condenser might assume serious proportions, and also that the behaviour of Condensers was subject to variations of temperature, etc.

Such defects were not of great account in the comparatively crude apparatus of those days, but with modern valve circuits where selective and critical adjustments are required, each condenser must be relied upon to absorb a minimum of electrical energy, to retain perfect insulating qualities, and, above all, to remain at a constant value of capacity under its normal working conditions.

Further, if good receiving results are to be obtained, condensers must have an actual capacity which is within very fine limits of the stated capacity.

Experience has shown that these conditions can only be obtained as the result of most careful design, selection of materials, and manufacture.

You will safeguard your own interests by specifying condensers which are the result of long experience.

*(Do not miss No. 2 of this Series.)*

**THE DUBILIER CONDENSER CO. (1921), LTD.,**

DEPT. D.

**Ducon Works, Goldhawk Road, LONDON, W. 12**

Telegrams: "Hivoltcon, 'Phone, London." Telephone: Hammersmith, 1084.

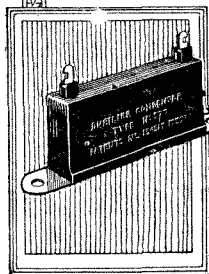

38

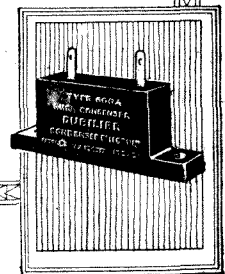
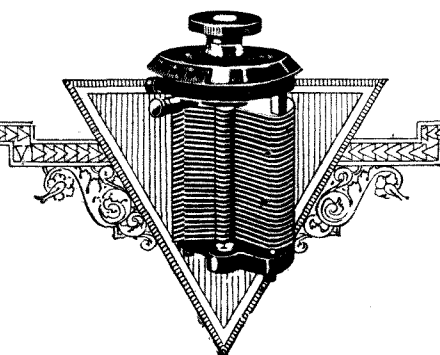

audible on the loud-speaker in London while 2LO was transmitting; Bournemouth came in loudly in an interval. The usual Morse jamming was experienced on the distant stations.

The finish and workmanship on this handsome receiver were found to be excellent, both inside and out, and the highest class of components had been incorporated.

#### A Knob and Dial

Constructors who take pride in the appearance of the finished instrument, as well as those who have been troubled at times by the propensity knobs and dials of the usual type display towards working loose and slipping round on the spindle, will all be welcome the handsome and well-finished knob-and-dial unit marketed (and at a really competitive price) by Messrs. Bowyer-Lowe and Co., Ltd.

This has a three inch black enamelled metal stamped dial, and a bevel scale with beautifully clear silver graduations from 0 to 100 on the semi-circle, reading clockwise from the top or further edge—which is often a great advantage with vertical or sloping panels. This dial is secured by two substantial screws to the large, comfortable knob; and the whole is secured on a spindle (it takes No. 2 B.A.) by a set-screw tapped through a strong brass collar, making a reliable and mechanical job. The metal dial has, further, a screening effect against hand-capacities—extremely useful in some critical positions in radio circuits.

#### A Variometer de Luxe

Messrs. Economic Electric Co., Ltd., have submitted for trial a large variometer, of the internally-wound stator and ball-rotor type, which is one of the handsomest pieces of radio apparatus we have had the pleasure of handling; and which in actual operating efficiency in no way belies its appearance. The dark-red composition stator frame is provided with feet for standing on the table (or eventually screwing down to a base-board, whilst screws are also supplied for panel-mounting in a vertical position, in which case the overall depth required is about  $5\frac{1}{2}$  inches.

The windings are of a generous gauge of green silk-covered wire; the almost miraculously small

clearance between rotor and stator gives a wide range of tuning: from about 250 to 420 metres on a P.M.G. aerial with windings in parallel and 290 to 1,250 metres with windings in series. Nickel-plated terminals provide connections when the series arrangement is used; for parallel connection a small nut close to the spindle at the scale end provides the terminal, the other two large terminals connected together by a wire providing the other connection. With this arrangement the variometer gave, on local broadcasting, with good suburban aerial and galena crystal, a signal strength at 13 miles which enabled speech to be clearly distinguished in a loud-speaker ten feet away. On single valve, with a small series fixed condenser, quite good loud speaking (for a small room) was obtained with merely a plate variometer and fairly high H.T.; with windings in series and no condenser The Hague came in well on two valves with tuned-anode-coupling and reaction on the latter.

A particularly clear bevel scale, reading to 100 divisions on the further edge, and a substantial fluted knob, fixed by a stout set-screw, are provided with the instrument.

Whether as aerial tuning inductance, or as plate-variometer (for which the high series inductance and appreciable distributed capacity when at maximum position make it particularly suitable) the low resistance and extremely sharp tuning of this fine variometer will make it invaluable to the experimenter; thus in the S.T. 100 it gave excellent signals whether as A.T.I. (windings in parallel, with small series condenser, .0002 $\mu$ F), or as plate-inductance, with the crystal-circuit across it (windings in series).

While it is by no means a cheap instrument, the fine workmanship and finish, as well as the wide utility and actual efficiency of this instrument, fully justify the price asked for it.

#### A Variocoupler

Uniform with the large variometer already described is a variocoupler marketed by Messrs. Economic Co., Ltd., with stator primary tapped at 14 points; and rotor secondary, with larger clearance than in the case of the

variometer. In appearance, workmanship, and style of mounting, it resembles the former very closely.

#### The "Megger."

With reference to a mention of the "megger"—for measuring high insulation resistances—in the article on "The Rapid Measurement of High-Resistances with the Neon Lamp," in the October number of MODERN WIRELESS, we are instructed that this word, commonly used as an abbreviation of "megohmmeter" in familiar speech, is actually a registered trademark which is the property of Messrs. Evershed and Vignoles, Ltd., and is applied to the particular form of electrical testing instrument manufactured by them. In the instrument a differentially-wound galvanometer is used, with a constant high-resistance connected in series with one winding, so that the deflections are sensibly independent of the speed of the generator over a certain range.

We are glad to learn that the same firm are marketing a smaller portable model of the instrument at a substantially reduced price, which will perform most of the routine testing required by the radio constructor and investigator. We hope to have an opportunity of putting this to a practical test shortly.

#### H.F. Transformer

A semi-a-periodic H.F. transformer for panel-mounting is offered by Messrs. Radio Instruments, Ltd. This has a range from 150 to 4,000 metres with 9 tappings; and being of the medium high-resistance type, does not require a tuning condenser to cover the range between tappings.

On test with two valves it gave good amplification on London broadcasting, and even with a small series aerial-tuning condenser and 70 volts, did not oscillate with too great ease, being easily controlled by varying series-condenser to large enough value and then tuning with variometer—or conversely, using a coil which requires a large enough series capacity. The shops came in well, and the Dutch concertina was found easily and was steady and clear, in spite of some jamming. The whole range was found to be effectively covered. Finish and workmanship were excellent as in the other instruments submitted.

**Aerial Insulators**

From Messrs. The Silvertown Co. we have received for test samples of their rubber-covered aerial insulators. These are in the form of a short cable, with a cotton cord structure insulated with rubber in a manner similar to that in cord tyres. Duralumin shackles and swivels are attached to ebonite blocks at each end, and a cup or sleeve in the middle keeps part of the surface dry even in heavy rain. The weight is small— $\frac{3}{4}$  oz. for the smaller, which has 5 in. of insulated portion and 2  $\frac{1}{2}$  oz. for the larger, with 7 in. insulation and a longer shield.

The breaking strain is exceedingly high, being comparable in fact with that of aerial wire. The small one sustained with ease the weight of a staff editor, even when abruptly applied.

On electrical test the insulation was found to be irreproachable. No leakage could be observed on high voltage even when water was

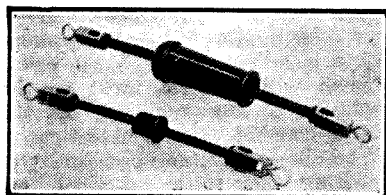

deliberately poured over the insulation, the cup keeping sufficient of the surface quite dry.

With the wide separation of the points of attachment, the capacity losses will certainly be reduced to a minimum.

The insulators are well finished and would be quite inconspicuous in use on the aerial.

**The "Ultra" Loud-Speaker**

An effective and moderate-priced loud-speaker of the above name has been submitted for trial. This instrument is of medium size, standing about 18 in. high; that submitted was of 4,000 ohms resistance. It is nicely finished in dull black, and has adjustable magnets, of the same type as the headphones of the same name, with an adjusting screw concealed in the base.

On test, it proved to be exceedingly sensitive, quite audible reception being obtained on the crystal alone with a good aerial and

tuner in the outer suburbs of London on local broadcasting. With valve receivers, the tone was more natural than with any other metal-horn loud-speaker compared with it, very pleasant and undistorted loud-speaking being obtained so long as it was not overloaded.

This instrument represents an excellent attempt to bring the loud-speaker within the reach of the man of moderate means and equipment, and should do a great deal towards establishing the radiophones as a permanently popular domestic device.

**The "Meg" Tester**

A smaller brother of the well-known "Megger" insulation tester, made by Messrs. Evershed and Vignoles, Ltd., has been placed at our disposal for a thorough trial. This is a lighter and more portable model than its elder brother, and is very much less costly. It is enclosed in an aluminium case, with folding handles for carrying, the driving handle being of very compact form and arranged at one end of the case. A protected dial in the top reads directly from 10,000 ohms to 1 megohm, and then to 10 megohms in units; up to 50 in tens, and finally to 100 megohms and "infinity." Well-insulated terminals are provided at one end for "line" and "earth."

The principle of the instrument is the same as in Messrs. Evershed and Vignoles, Ltd.'s "Megger"; this instrument is of the variable voltage type, the generator giving 500 volts at 100 revolutions of the handle per minute. By the use of a differentially wound ohmeter and a constant standard resistance in series with the one winding, the reading is made sensibly independent of the generator voltage over a considerable range, and the readings are completely dead-beat. The workmanship and finish are beyond criticism.

On a thorough and extensive trial in the most varied testing work the instrument proved to be exceedingly convenient and accurate. The insulation resistance of fixed and variable condensers of the usual small capacities, insulation faults, in concealed wiring of receivers, shorts in transformers, and the peculiar properties of some of the alleged "ebonite" now on the market—all these could be shown

up unerringly in a few moments with this instrument. It is admirably adapted for the general run of testing necessary in radio construction work, and can be heartily recommended for the discriminating amateur and professional maker alike.

A neat carrying case with strap is supplied by the makers.

**A Valve-holder Template**

A practical little device which will save amateur constructors much lost time and spoilt ebonite is the Morris marking template for indicating the correct spacing of holes for valve-legs, and a centre-hole for a screw.

This is in the form of a metal disc, 2  $\frac{3}{8}$  in. diameter, with a silver finish, having the necessary marking points and a centre hole. By placing it on the panel with the centre in the desired position, and giving it a light tap with a hammer, the positions of the valve-legs are clearly marked on the ebonite.

**"Tellite" Crystal Detector**

Messrs. Elwell, Ltd., have submitted for trial a high-class and very well finished crystal detector, mounted on a small panel base, with the "tellite" crystal and fine adjustment device described recently in the columns of *Wireless Weekly* in connection with the firm's B.B.C. crystal receiver.

On test, this compared favourably with a galena detector in actual reception of broadcasting. It was easily set, and showed considerable stability, maintaining its sensitive condition even when handled.

**SPECIAL NOTE.**

The Wonderful New "Cowper" Circuit first described in "Wireless Weekly" will be explained in next month's "Modern Wireless."

# TINGEY SUPERFIVE CABINET RECEIVER

The last word in Perfect Reproduction, Selectivity, and Strength of Signals.

Enclosed in Lock-up Oak Cabinets, complete with High Tension Battery of 120 Volts.

Composed of Two High Frequency, one H.F. Rect., and two L.F. Power Valves. By means of two simple Wander plugs any combination or number of valves may be employed.

Each set is supplied with a set of Coils covering the wavelengths of British Broadcasting Stations. Other sets of Coils may be supplied at extra charge.

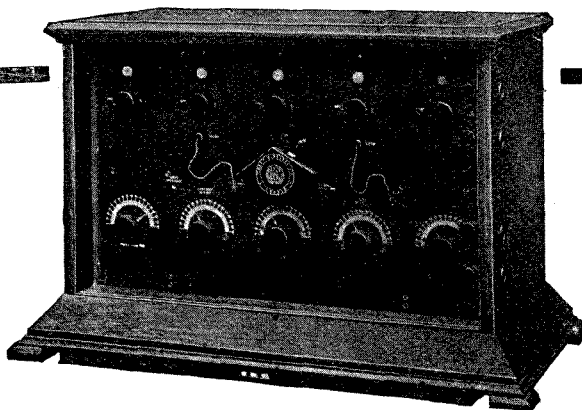

Price, as illustrated, including Special Valves and High Tension Battery .... **£56 . 5 . 0**

ASK FOR SUPERFIVE PAMPHLET.

We manufacture Valve Sets, 1, 2, 3, 4 and 5 Valves, also an excellent Crystal Set.

Send for our new Components LIST--free on request.

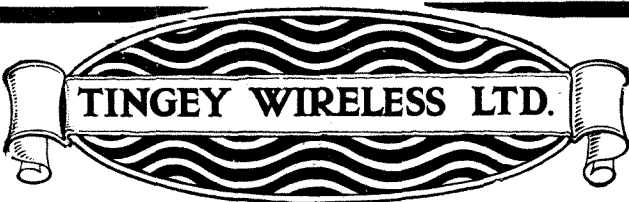

Open 8 to 7, Saturdays 8 to 1

Few Agencies still open.

Offices and Showrooms :—

92, Queen St., Hammersmith, London, W.6.

'Phone :

Hammersmith 1916.

'Grams :

"Tingoidar, London."

# FELLOWS

The "Fellocryst" Super receiving set is a simple and reliable crystal set for broadcasting reception between 30 and 500 metres, up to a range of from 15 to 20 milcs.

It comprises an ebonite panel mounted in an oak cabinet, tuning coil, silicon crystal detector, variable condenser, 4,000 ohms double headphones, 100 ft. aerial, 2 insulators.

Price **£3 7 6** plus B.B.C. Tax - 1/-

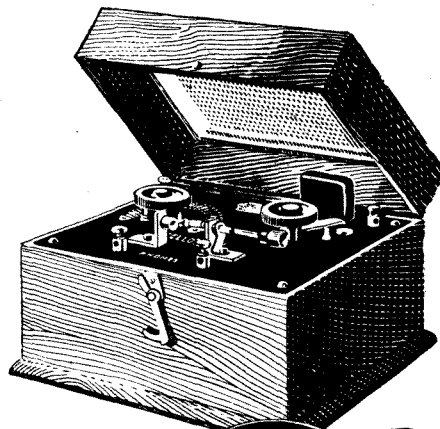

The "Lightweight" Headphones weigh under 6 oz., and are extremely comfortable. With the special spring adjustment the earpieces may be moved into any desired position or separated without the use of adjusting nuts. This fitting is specially designed not to tear the hair. Wound to 4,000 ohms, they are very sensitive and are well made with duralumin] head bands, stalloy diaphragms, etc.

Price **18/6**

— Advt.: Fellows Magneto Co., Ltd., London, N.W.10 —





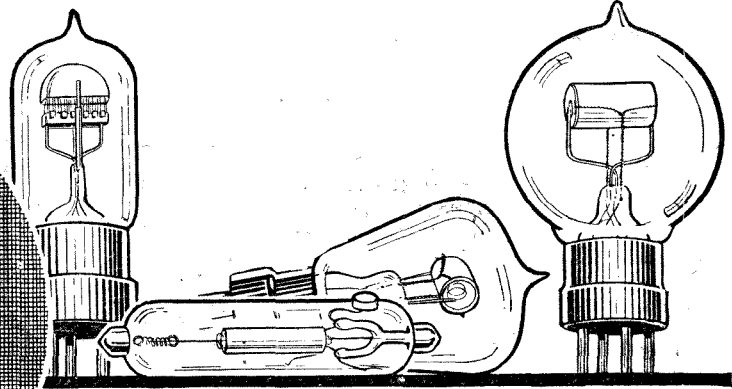
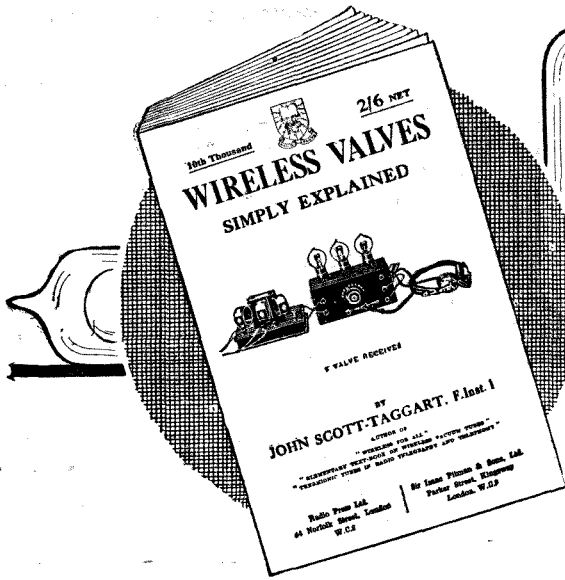

# Valves

**T**HE Valve is undoubtedly the most important part of any Receiver. If your Valve (or Valves) is not functioning correctly, you are not getting the best results from your Set.

Before you can hope to become a skilled driver and obtain the most pleasure from your car you must know how it works. So with Wireless. You cannot hope to get the greatest enjoyment from "listening-in" or experimenting until you have mastered the fundamental principles of Radio.

Dependent on this lies your ability to understand the theory of the Thermionic Valve. Know how it rectifies, how it oscillates, and how it amplifies, and your progress in obtaining further Radio knowledge will be rapid.

## Wireless Valves Simply explained

By JOHN SCOTT-TAGGART, F.Inst.P.,

is the one Book on the Valve which will really teach you—commencing at the very beginning—everything you need know about the Valve. It has been recognised by all the experts as the standard popular-priced book on the subject.

Purely scientific explanations are omitted because the aim of the author has been to provide a book which, while being absolutely accurate, can be read and understood by novice and experimenter alike.

Get a copy to-day and begin to understand exactly what is happening while your Receiver is working.

### Contents

- The Theory of the Thermionic Valve.
- The 3 Electrode Valve and its Applications.
- Cascade Valve Amplifiers.
- Principles of Reaction Amplification and Self-oscillation.
- Reaction Reception of Wireless Signals.
- Continuous Wave Receiving Circuits.
- Valve Transmitters.
- Wireless Telephone Transmitters Using Valves.
- Broadcast Receivers.

# 2/6

RADIO PRESS  
Wireless Library,  
No. 10.

From all Booksellers  
or Newsagents,  
or 2/8 post free.

**Radio Press, Ltd.**  
PUBLISHERS OF AUTHORITATIVE WIRELESS LITERATURE  
DEVEREUX COURT, STRAND, W.C.2.

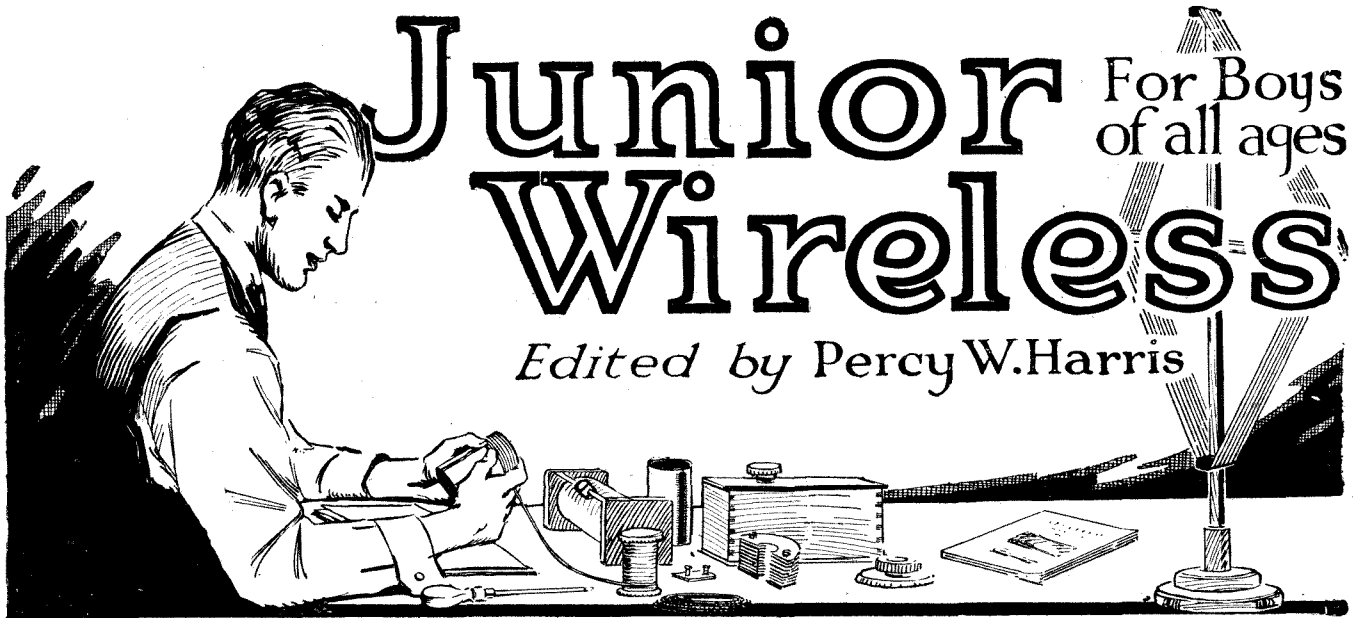

Vol. 1. No. 4.

DECEMBER.

Published Monthly

## THE EDITOR'S CHAIR

WELL, what are you going to have for a Christmas present? Something wireless, of course? A Pea-nut valve, perhaps, or one of those new dull emitters that burns such a small current. It may be it is a good intervalve transformer you want. Whatever it is I wish you the best of luck.

These new valves are wonderful things. I have been trying them recently and find that they give splendid results in one or two-valve sets, although they do not give quite the volume in loud-speaker work that one can get from the old types of valves. In any case they are splendid for portable sets, and I suggest that this holiday time my readers will try what they can do in making compact little sets with dry cells, so that they can be carried about in small attache cases. Such a set, a "Ducon," and a length of flexible wire, should enable you to get splendid signals in any friend's house where electric light is fitted, provided, of course, that the house is not too far away from a broadcasting centre. Next month I hope to show you how to make a simple little set of this kind, which will even work a loud-speaker in the vicinity of a broadcasting centre.

This month we have several good things in our pages. I think you

will all be interested in Mr. Cowper's little variometer set, made with bell wire. We have already illustrated one or two simple sets in JUNIOR WIRELESS, but this one, I am sure, is simpler than ever. Certainly the results that have been obtained on it are better than those

readers were able to visit the All-British Wireless Exhibition at the White City last month. The first Wireless Exhibition I ever saw formed part of a larger electrical exhibition in New York between twelve and thirteen years ago! Valves, of course, were unknown at that time—at least, the kind of valves we use nowadays, but there were numerous crystal detectors, many of them much superior to those we use to-day. Nowadays the simplest possible adjustment is fitted with a ball and socket and a cat-whisker on a sliding rod. In those days we took much more care in our adjustment and the most elaborate micrometer and spring adjustment were provided, so that once we found a good sensitive spot—and there were not many on the crystals at that time—we could keep it for a long period. Plenty of American amateurs had transmitting sets at the period of which I am speaking, and some used as much as 5 kilowatts! The sets were all spark transmitters, most of them giving the rough "ragged" note which characterised early sets, although several had quite passably good musical notes. Very often the commercial work in New York harbour was quite upset by the enthusiastic amateurs sending Morse signals to one another.

THE EDITOR.

### Contents.

	Page
Editor's Chair - - -	49
Contrasts - - -	50
On an American Battleship (Illustrated)	50
Red Indians listening to a Broadcast Concert - (Illustrated)	51
Invisible Band - - - (Illustrated)	51
The Telephone Receiver - By PAUL D. TYERS.	52
A Really Loud Crystal Set - By A. D. COWPER.	54
Simple Soldering Jobs -	58

of many expensive crystal sets; much of the virtue of this receiver lies in the use of the thick wire, and I advise you to follow Mr. Cowper's instructions carefully if you want to get the same good results.

No doubt a good number of our

# CONTRASTS

By F. H. PHILPOTT.

*An entertaining article in reminiscent vein which will recall memories of other days to older readers.*

IN these days of the ubiquitous "listener-in" it is a matter of difficulty for the ex-sapper to realise what a short period of time has elapsed since he was sitting on a petrol-can, wearing the phones for his twelve-hour stretch, with the "W.T. set, crystal, trench, B.F. pattern" balanced on his knees to keep it out of the wet. Looking back, it seems impossible that a receiver could ever be persuaded to give out a signal under such conditions, which would make a dignified modern broadcasting set burst a condenser to contemplate; and it is surely to the eternal credit of an enthusiastic branch of the Signal Service that trench wireless was at all possible. (Let the writer hurriedly confess to being one of the "eternal creditors.")

As may be imagined, there was always a glorious uncertainty about what the set would do, and this largely contributed to the premature ageing of many worthy non-coms.; it has on occasion strained the vocabulary of even a staff officer. This is "saying a mouthful," as our Yankee comrades frequently remarked.

Things were sufficiently difficult when using the crystal set, but this was practically self-contained and needed an accumulator for transmitting only. This battery was really very little used and needed recharging but comparatively rarely. When, however, the

"blessing" of valves was first conferred upon us—ye Guglielmos! To begin with, there were details of the sets that puzzled us then, and to some extent do still. There was, for instance, that dainty item—the "semi-portable" high-tension battery, which was so much more "semi" than "portable" that it

## ON AN AMERICAN BATTLESHIP.

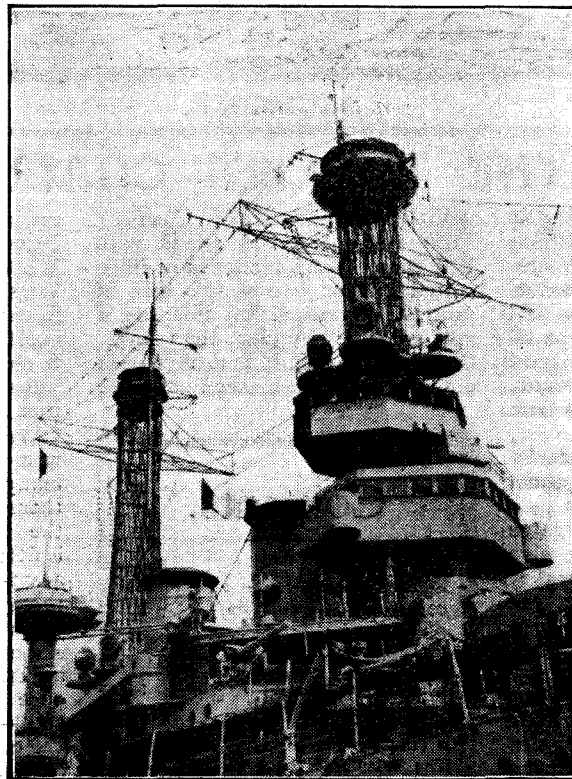

*The elaborate wireless aerials on the U.S.S. "Wyoming"  
Notice the great lattice spreaders carrying cage aerials.*

was all one man could do to carry it, and was contained in a huge wooden case, and fitted with two thick rope handles. It had the appearance of a piano in its adolescent period. Every station carried at least one spare H.T.! One frequently notices a haggard man hurrying past a Government surplus store with head averted and shuddering. You may feel sure this unhappy wretch is an ex-"Divvy" wireless operator, and he fears to see his old friend the semi-portable H.T. Much will be forgiven him.

The demands of the valves were the cause of those frequent and pleasant trips to the battery-charging station, up miles of crowded, and usually a trifle damp, communication trenches. These journeys were performed in our spell "off duty," although we would comfort ourselves by the knowledge that, according to the official manuals on the subject, this job was being done for us by "fatigue parties of infantry, detailed for the purpose." The authorities concerned evidently considered this necessary, and we were in hearty



Red Indians listening to a broadcast concert with a portable set and loud-speaker.

accord, since they had with customary consideration supplied an alleged fool-proof alkaline battery giving about 3.7 volts and weighing several cwts. per battery. We are prepared to swear to this.

The "casualties" amongst these batteries were, for some reason, like the batteries themselves, so extraordinarily heavy (even the Government calls them *fatigue parties*!) that we were later issued with a civilised accumulator of just possible carrying weight, that did not sink out of sight in the mud quite so readily. Even with these, however, it was surprising how frequently the batteries were "blown up by shell-fire" on the very day that we were relieved!

Someone learned in statistics discovered a direct ratio between losses of accumulators by enemy action and the distance to be covered by the station party after being relieved, but he could offer no satisfactory explanation—at least not satisfactory from the signal officer's point of view. You "broadcasters" who hate to carry your "4-volt-40" to the charging shop, imagine yourself with gear hanging from every part of your body except your ears (these were forgotten by equipment designers; but speak quietly, there

may be another war), imagine this, and add a 4-volt-eighty to each hand, and presume a wade of perhaps three miles along a ditch, you may then possibly have a glimmering of the reason for Fritz's accurate shelling of our "batteries."

This hand transporting of stations was, I believe, our most detested job, and the cause of comedy and tragedy. One remembers an occasion when a party, having for three hours "humped" portable masts, earth-mats, H.T., valves, rations, candles, and, of course, equipment and rifles, through a particularly bad section of trenches, found on arrival at the destination and erecting the aerial that the station was minus one insignificant little detail—the panel! And Sergeant's elocution! We had no wireless concerts, but we had our compensations!

It is much nicer to go to work every day and to know we shall spend every night in bed undisturbed. M'yes. . . . Heigho! Poor old "Dusty"! How he would have enjoyed this "Goblins dance"!



"The Invisible Band" which attracted so much attention in the Lora Mayor's Show this year. It picked up music played at 2LO and distributed it through loud-speakers.

# THE TELEPHONE RECEIVER

By PAUL D. TYERS.

*Telephones merit far more attention than is usually given to them by the beginner. This article directs attention to the principles on which they work and will help the user to get the best from these sensitive instruments.*

THESE is probably no instrument more familiar in everyday life than the telephone, and in a wireless receiver it is equally important. In principle and in operation the telephone as used for wireless purposes is identical with that employed on the ordinary Post Office system. The difference lies chiefly in the actual construction. In order that the operator may have both hands free, the receiver is condensed into a small "watch case," two usually being employed attached to each end of a head band. A

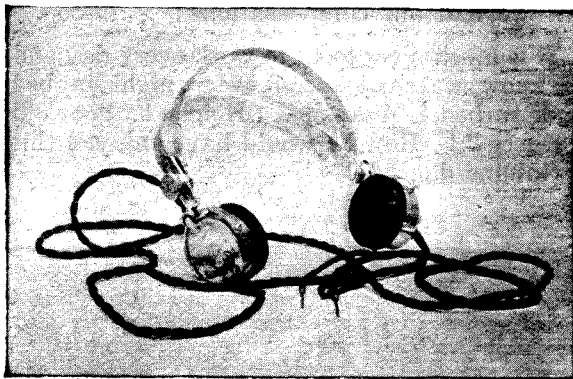

Fig. 1.—A pair of typical modern telephones.

typical form is shown in the accompanying photograph. The receiver consists essentially of a strong permanent magnet around the ends of which are two coils of insulated wire.

The magnet and coils are firmly fixed within a case of some suitable material, the shape being as shown at C, in Fig. 2. The height of the magnet is such that the ends fall just below the level of the edge of the case. A thin soft iron diaphragm D rests on the edge of the case and is held rigidly in position by the cap E, which is screwed on to the case. The cap is usually of moulded ebonite or similar material and has either one big hole in the centre or a number of small ones, as is actually shown in the accompanying photograph.

## The Principle of the Telephone.

The telephone having been described in detail, the mode of operation can easily be followed. It is well known that a permanent magnet, that is, a piece of magnetised steel, has the property of attracting other pieces of iron or steel. As may be expected, the force of attraction depends upon the strength of the magnet, or upon the strength of the "magnetic field," as it is called, which exists in the neighbourhood of every magnet. The production of a magnetic field is not confined to a permanent magnet, but exists when a current flows in a coil of wire. The intensity of the magnetic field in this case can be increased by inserting in the coil a "core" of iron or steel, the arrangement then being known as an electro-magnet.

If steel is used, it is found that on stopping the current the steel retains its magnetism. Permanent magnets are in fact produced by this method.

## The Operation of the Telephone.

A cross section of a telephone receiver is shown in Fig. 3. It will be seen that the

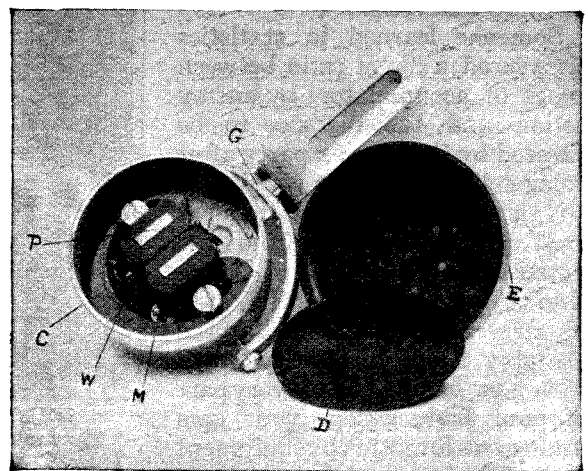

Fig. 2.—Construction of the earpiece.

diaphragm is supported on the edge of the case in such a position that the middle portion is nearly touching the "pole pieces" P of the magnet. In order to simplify the illustration the pole pieces have been drawn near the sides of the case. Actually they are placed in the centre, where they naturally have the greatest effect on the diaphragm. As explained above, the magnet will attract the soft iron diaphragm, and consequently it will be almost imperceptibly bent downwards in the middle. The coils of wire wound round the magnet poles are connected to the receiving set, and when signals arrive a very small amount of current passes through them. This current, as has been explained, will also produce a magnetic field, and since the coils occupy approximately the same position as the permanent magnet, the field due to the magnet will be in the same area as that due to the current in the coils. Hence it is obvious that the latter field will also affect the diaphragm to a considerable extent. Thus, for example, a certain signal will produce a certain current, which will cause a definite change in the total field affecting the diaphragm. As a result of the variation of the force which is exerted on the diaphragm a small movement will occur.

Now, the form of the movement will depend upon the nature of the current passing round the windings of the telephone. If the current passes in one direction, the magnetic field which it produces will assist the permanent magnet, and if it passes in the other direction it will oppose that due to the permanent magnet. In the one case the diaphragm will move nearer the permanent magnet, and in the other it will move away from it. But it has been shown that the nearer the diaphragm is placed to the poles of the magnet the more sensitive will be the telephone, and consequently a telephone should be so connected that any steady current from the high-tension battery which passes through the windings tends to assist the field due to the permanent magnet. For this reason, the terminals of a telephone receiver are frequently marked, indicating the correct connections.

#### How the Telephone Reproduces Signals.

Having studied the fundamental principle of the operation of the telephone, it is now easy to understand the manner in which speech or a musical note is reproduced. Suppose that the telephone is being used in conjunction

with a crystal detector for the purpose of receiving signals from a spark station having a fairly high pitched note of, say, 1,000 per second. The radiation from the station will produce across the ends of the tuning coil of the wireless receiver minute electrical potentials, or pressures, which consist of a series of pulses rising to a maximum value in each direction at the rate of 1,000 per second. If the telephone were connected directly to the

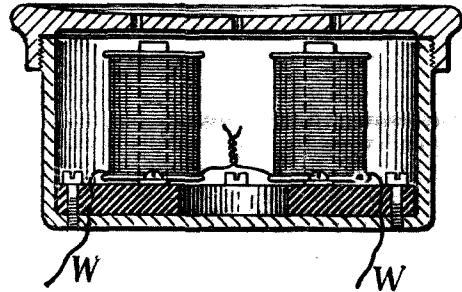

Fig. 3.—Cross section of a telephone receiver.

tuning coil it would not respond to these rapid alternations and a crystal detector is therefore employed, which has the effect of cutting off one half of the alternations. Consequently the telephone is supplied with little pulses of current at the same rate of 1,000 per second, with the result that the diaphragm is pulled towards the magnets 1,000 times per second. Hence it is seen that the diaphragm vibrates at the same rate, emitting a musical note, at a frequency of 1,000 per second.

The reproduction of speech is merely a development of the above process, since speech consists of a complex arrangement of a number of musical notes. The foregoing explanation is merely an indication of the fundamental principle of the telephone; in actual use many more factors have to be considered, and the vibrations of the diaphragm are in reality more complex than has been assumed, even with the purest note. It can be easily seen, for example, that the behaviour of the diaphragm when the telephone is used with a crystal set and when it is used with a valve set is different, since in the latter case the diaphragm will be deflected continuously owing to the steady current through the valve. In this case the incoming signal causes a variation about a mean value of the steady current. Thus it is seen that the diaphragm will be affected by a series of increases or decreases of current which will naturally have the same effect as a series of impulses starting from a zero value.



## A REALLY LOUD CRYSTAL SET

By A. D. COWPER, M.Sc. (Staff Editor).

*A lead pencil and some bell-wire are the chief components of this set.*

**I**F you live in a suburb of a broadcast centre and can put up a high aerial, you can make a crystal set which will give speech and music really audible on a loud-speaker.\* It will only require a couple of hours' work, no other tools than a penknife and a red-hot nail, while the outlay should not exceed 5s.

For really loud signals on the crystal there is nothing to beat a simple variometer made of No. 18 double-cotton-covered wire, with a galena crystal. There is no need for any elaborate former to hold this wire, which is stiff enough to keep its shape if wound simply in a rough coil of circular cross-section (an "anchor-ring") and loosely taped up—the looser the better—while two such coils make an extremely efficient variometer if one, which is made smaller than the other, is mounted on an insulated spindle so as to rotate inside the other.

To make this receiver, all you need is a base-board, a vertical spindle (a pencil), four telephone terminals (the sort which have a screw to go into wood), less than ½ lb. of No. 18 D.C.C. wire, and a small piece of crystal, together with some insulated flex for leads and earth connection. The base-board is one of those sold ready polished and finished for mounting household electrical fittings; it can be about 6 in. square, or if

\* Of course, this does not mean that the sound will fill a room as it will from a valve set.—EDITOR'S NOTE.

circular in shape, 6 in. diameter and will cost about 10d. The telephone terminals cost 2d. each; the wire about 1s. 3d.; 6d. worth of crystal (hertzite, rectarite, permanite, or practically any other fancy name ending in "ite," but not zincite, bornite, or pyrite, which are quite different) will suffice for several. With half a dozen yards of plain single flex (about 1s.), with shellac varnish, some narrow tape, and a piece of tin-foil from a cigarette box, the total cost is about 5s. without aerial equipment and phones. One hun-

high aerial, a single high-resistance earpiece at 8s. or 9s. will be ample, while, of course, a pair of high-resistance phones at about 21s. are a luxury, but worth while if you can get them.

Your base-board will require six holes in it: one in the centre to take the pencil, which is your insulated spindle; one about the same size, at one side, for the crystal; and four small holes for the terminals to screw into, arranged as in the figure. The small holes you can make with the nail, if you do not possess a small gimlet

or drill; the two larger start with the nail and finish with your penknife blade, making the centre one only just large enough for the pencil to fit in tightly and vertical. Fix it in with sealing wax if it is not firm.

For the variometer wind 15 turns of the No. 18 D.C.C. wire round some circular object about 5 in. diameter (the large end of a big milk-jug is just right). It does not matter if they slip loose when winding. Then take the rough coil off, bunch it loosely together,

and tie a couple of turns of tape round it at opposite sides so as to form a ring. Push the pencil temporarily through the middle of this ring, between the turns of wire, and bind four turns of tape round close to the pencil, two on each side of the latter. This finishes the "stator."

A similar, smaller ring, about 4 in. diameter, but this time of 20 turns, wound loosely on, for example, a coffee canister or smaller

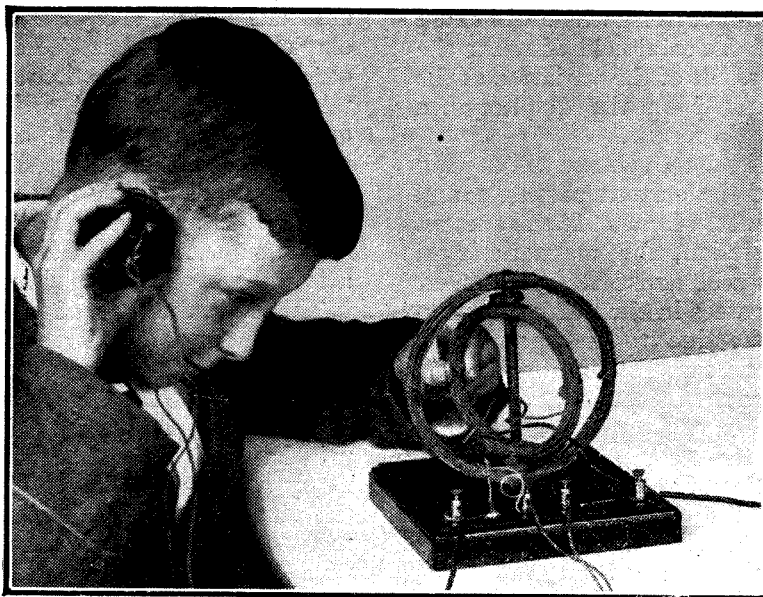

*This crystal set cost five shillings, including the telephone!*

dred feet of 7/22 aerial wire, with a couple of insulators, will cost about half-a-crown. For telephone, if you are fairly near your broadcast station, an ex-Army low-resistance single receiver at about 3s. 6d. will give good results: these are getting scarcer now; that shown was got from S. T. Corry, in Southampton Row, London; but if you live some way out in the country and, in any case, if you cannot put up a good

jug, bunched loosely together and taped up like the last, makes the "rotor."

Cut two thin slices of cork from an ordinary large cork and make a hole through the centre of each so that they will slip stiffly on the pencil. Then place your stator and rotor in position, pushing the vertical pencil through the gaps made when taping up the coils, and putting a cork disc on each side between stator and rotor, as in the diagram.

One free end of the stator coil, which should be left about 5 in. long for this purpose, is then bared of insulation for a couple of inches, brought round under the terminal marked AE, then to the crystal-holder (the second larger hole in the base), where a loop of the wire is pushed down for the crystal to rest on. The crystal is wrapped in tin-foil so that one bright face is exposed (do not touch it with your fingers more than you can help) and pushed into this hole so that the tin-foil makes good contact with the wire loop, the crystal is held firmly, and the sensitive surface projects up above the base-board.

To the other free end of the stator coil a 4 in. piece of the insulated flex is attached (best by soldering, if you can); the other end of this short flex is attached similarly to the first free end of the rotor coil. The further end of the rotor coil has a 6 in. piece of flex attached: this is taken to the terminal marked E and clamped under the latter. Then a short piece of the No. 18 wire is clamped under the same terminal E and under the nearer of the two phone terminals PH.

For cat's-whisker and holder, a 1 in. piece of the flex has the ends bared of insulation for ¼ in., and at one end the thin wires which make up its core are partly cut away, and the remainder slightly twisted, so as to make a small, resilient brush. A 3 in. piece of the No. 18 has its ends bared; then one end is wound tightly on a nail in a close spiral, so as to make a small tube, in which the end of the piece of flex is thrust and pinched in securely on the bared portion. The thick wire is then bent in a loop, as shown in the detail drawing, and secured under the second telephone terminal and adjusted by bending carefully until the brush just touches the sensitive surface of the crystal

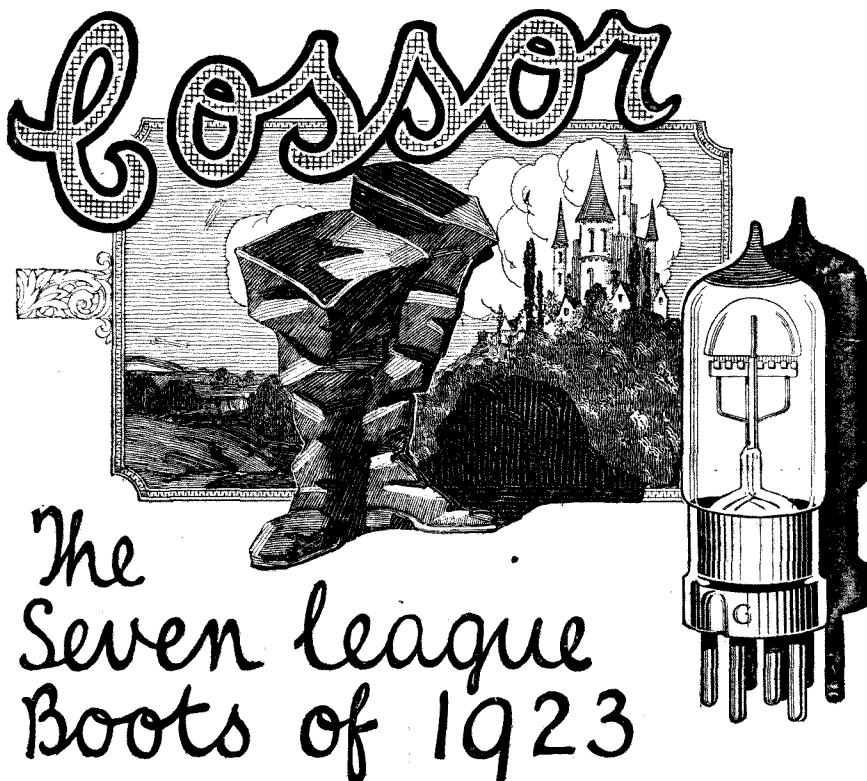

## The Seven League Boots of 1923

**J**UST as our ancestors were intrigued by distance, so we, in this year of grace of 1923, are intent on breaking records for long-distance wireless reception.

But special jobs need special tools. The Valve for long-distance work should be designed for this specific purpose. Therefore, several months ago we set out to discover for ourselves exactly what characteristics should be possessed by a Valve for High-Frequency Amplification.

We made some interesting discoveries, all of which are embodied in the P.2—the Valve with the red top. This Valve is essentially one for H.F. Amplification, and when used with any of the usual types of coupling—tuned anode, transformer, resistance, reactance-capacity—it is capable of the most astonishing results.

You will note, of course, that it is built along standard **COSSOR** lines—with curved filaments, hood-shaped Grid and Anode.

If distant Stations are out of your reach, don't blame your Set—insert a **COSSOR** P.2 as an H.F. Amplifier. You'll be more than satisfied.

Cossor Valves are sold by all Dealers.

Types: P1. For Detector or L.F. use } 15/-  
 P2. (With red top) for H.F. use }

"Wuncell" (the improved Dull Emitter) 30/-

Cossor Valve Co., Ltd.—Highbury Grove, N.5.

Gilbert Ad.



## Save Money this way—

It is not difficult to make the majority of the components for your Wireless Set if you can only get the right information.

The book "The Construction of Wireless Receiving Apparatus," should be particularly useful to any enthusiast who possesses a few simple tools and who can follow out elementary instructions. With a little care, your home-made apparatus should work almost as well as bought components, and will leave you money to spend in other directions.

## You can make all these Components at home—

- Anode and Grid Resistances.
- Filament Rheostats.
- Potentiometers.
- Crystal Detectors.
- L.F. Transformers.
- H.F. Transformers.
- Basket Coils
- Slab Coils.
- Solenoid Coils.
- Duolateral Coils
- H.T. Batteries
- Condenser

1/6

From all Booksellers, or 1/8 post free direct

RADIO PRESS, LTD.,  
DEVEREUX COURT, STRAND, W.C.2  
Radio Press Wireless Library No. 8.

at several points, but without short-circuiting to the tin-foil or wire lead.

Your receiver now only needs a good coat of shellac varnish on the coils and tapes to make them damp-proof, and drying (best near a stove or open fire to finish the drying). Connect up the aerial lead-in to terminal AE, and as short a length of flex as you can arrange from terminal E to a good earth (on bright surface of water-tap or clean-scraped pipe, or large can buried deep in the earth just below your lead-in window, in damp earth); connect the phone to the terminals PH, and try slightly moving the cat's-whisker brush with a light touch over the crystal, while at the same time turning the rotor into different positions relative to the stator. The B.B.C.'s timetable will tell you when to try; when you have found the best position for the variometer, leave it there, as there is no purpose served in continually adjusting it, and it will only wear out the insulation on the wire. The only real difficulty

is the adjustment of the cat's-whisker, and this type of brush contact is the easiest to adjust.

The set shown in the photograph tuned in 2 LO on the loud-speaker, without any head-phones, on a good aerial 13 miles away, just three-quarters of an hour after the start was made with the bought components (without stopping for varnishing). You should not find it a very tedious task to do the same.

On the aerial mentioned London was readable at 10 ft. on the loud-speaker in a quiet room (2000 ohm small Claritone); with single 4000 ohm head-phone, the news bulletin was intelligible with the receiver a foot away from the ear; with an ex-Army low-resistance phone the latter had to be brought to 6 in. away. On a low 30 ft. test aerial, badly screened, the ex-Army phone was pretty quiet, but high-resistance phones gave pleasantly-loud signals. On an indoors aerial, 6 ft. long and about 8 ft. high in an upper room, 2 LO could still be heard with 4000 ohm head-phones.

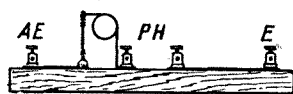
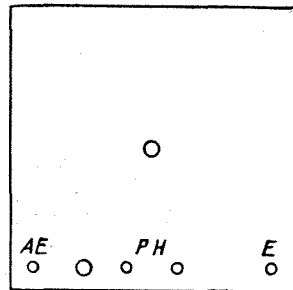

BASE BOARD

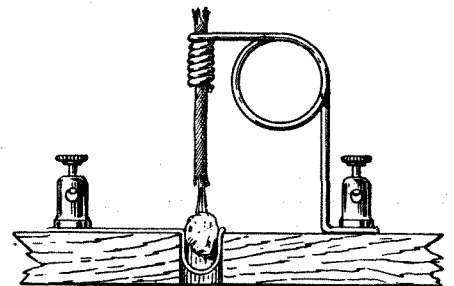

CAT'S WHISKER AND CRYSTAL-HOLDER.

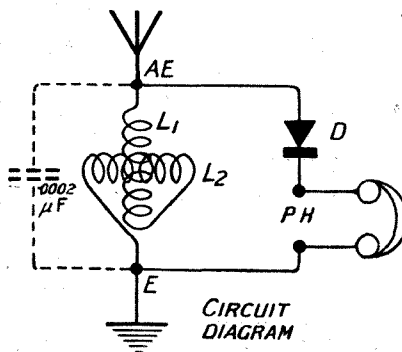

CIRCUIT DIAGRAM

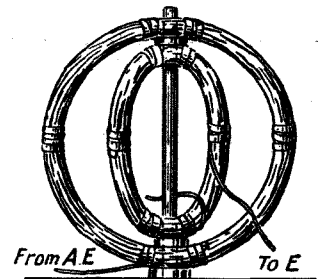

VARIOMETER COILS

Details of constructional work.

On a good country aerial (35 ft. mast) at over 30 miles from 2 LO the head-phones could be lifted away from the ears with comfort, using two pairs of high-resistance phones; and late at night Birmingham, some 80 miles away, was just audible—on a similar tuner and good crystal. This needs a good aerial, though, with a short, well-isolated lead-in and a first-class earth. If you take trouble to get your aerial high up, at least at one end, keep the lead-in short and well isolated from walls, etc., and make a good, wet earth, you should do as well with this simple receiver. With proper adjustment of the crystal, it should, at any rate, give as good signals as any expensive cabinet crystal set.

You may have a little trouble in getting No. 18 D.C.C. wire; but do not be persuaded to take a smaller size, as you will not get as good signals, and the coils will not stand up so well. Most electrical shops have the instrument-boards. That in the receiver illustrated, together with the wire and recarite crystal, was supplied by the Economic Electric Co., Ltd.

If you want to try a short indoor aerial, or happen to be situated near the Aberdeen station, you may find that a few more turns of wire in the coils are needed; Cardiff listeners equipped with long, low, double aerials or long lead-in, may have to take a few turns off the stator to get best results. You can bring in the ship stations on 600 metres, if you live near the coast, by putting a .0002  $\mu$ F fixed condenser across the AE and E terminals as shown in dotted lines in the figure. Do not buy the cheap and nasty type of condenser: they are worse than useless, usually, and will give you no results.

## A NOTE ON FRAME AERIALS

The emf induced in a frame by a passing electromagnetic wave is approximately proportional to the area of the frame and inversely proportional to the wavelength. Frame aerials are therefore more efficient on the relatively short broadcasting wavelengths than on long waves, and large frames are more efficient collectors than are small ones. As a counterbalance to the relatively high efficiency of frames on short waves we have, however, the fact that shielding effects become pronounced as the wavelength decreases, and for this reason reception by a small frame is often very poor when attempted on the ground floor of a house surrounded by trees or other houses with their water pipes, lead roofs, etc. The obvious remedy is to install the frame as high up as possible, and there will be found in most houses a space between the top floor ceilings, and the roof in which can be rigged a suitably large frame or frames permanently fixed in the right direction. A supply of 2-inch nails, some reel insulators and a reel of No. 22 SWG double cotton covered copper wire is all that is required for the construction of the aerial, and the down leads may be run on cleats inside the house or out under the eaves, down the outside of the house in one span and in through a convenient window sash. In any case the down leads should be well separated from each other and from the walls.

In using frame aerials it is well to bear in mind that the best results are usually obtained with a small value of tuning capacity. The valve is a potential operated device, and with a small tuning capacity the potential variations are high. There is a tendency to instability in some amplifiers, however, if this is carried too far. A 25 vane variable air condenser (0.0005 mfd max) is suitable, and the total length of wire required to make a one-turn frame tuning to Broadcast Stations with such a condenser is about 80 feet. For a small 10-turn frame, with  $\frac{1}{8}$  inch spacing between turns, 60 feet of wire will suffice.

## PLEASE—

*Request the Pleasure of the Company of Your Friends to YOUR "Listening-in" Party on Dec. 23, at 8.30 p.m., to hear Christmas Carols by four gentlemen of St. Paul's Cathedral Choir, simultaneously Broadcast from 2 L.O. in aid of St. Dunstan's.*

Please make a Collection on behalf of St. Dunstan's Work for Blinded Soldiers. — Collecting Envelopes will be gladly sent on application to St. Dunstan's Headquarters, Inner Circle, Regent's Park, N.W.1.

## LOOK!

How attractive these little "ads." are on the Pages of

JUNIOR WIRELESS

## BOOK!

yours for the  
January Number.

**SCHEFF PUBLICITY  
ORGANISATION. LTD.**

(Advertisement Managers, *Wireless Weekly* and *Modern Wireless*),

**125, Pall Mall, London, S.W.1.**

'Phone—Regent 2240 (2 lines).

READ

"Wireless Weekly" 6d.

# SIMPLE SOLDERING JOBS

*Successful soldering often means successful apparatus.  
Here are some very useful hints.*

SOME boys, and not a few of their elders, shy at soldering, regarding it as a job that can be done satisfactorily only by those of vast experience. When making up sets they rely upon nuts or even on the twisting of wires together for their connections. The result is, first, that there is an undesirable amount of resistance in the set, for the unsoldered joint offers considerable resistance to the passage of high-frequency currents, and secondly, that the apparatus is not reliable; nuts are always apt to work loose, and the slightest shake in a connection may lead to noises and oscillation

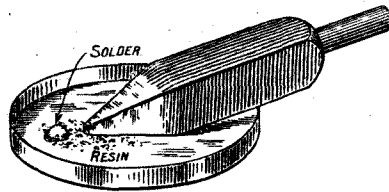

Fig. 2.—Tinning the point.

The first point lies in the selection of the soldering-iron. The old hand who has had much practice in its use chooses a large, heavy iron because he knows that it will retain its heat for a long time and so will enable him to do quite a big job without his having to replace it in the gas-ring or the blow-lamp. For the beginner it is better that the iron should be on the light side, since such a tool feels less clumsy to unpractised hands. It can be made still more handy in the following way: Place the iron rod in a vice and remove the wooden handle, which can easily be done by twisting it and applying a little brute force. Then take a hacksaw and shorten the rod by several inches. Place the handle on again and you have a tool which does not feel at all unwieldy even to the inexpert.

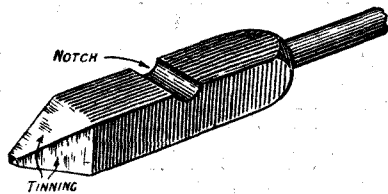

Fig. 1.—Point trimmed up and notch cut.

in a valve set, and to weak signals, or even to there being no sounds at all in the receivers.

As a matter of fact soldering is one of the easiest jobs that the wireless constructor is called upon to tackle. The making of plain connections between copper and copper or copper and brass is one of the simplest kinds of soldering, and in making up wireless apparatus we are not usually called upon to do any particularly delicate or tricky work. Everything is quite straightforward. After a little practice you will find yourself perfectly capable of using the soldering-iron with complete success.

And now to prepare the iron for use. Place the copper part in the vice and file up the point into the shape shown in the first drawing. Also cut with a round file a deep notch in one face of it. Now heat the iron in the gas-ring or the flame of a blow-lamp. Clean it by rubbing lightly with a cloth and bring it into contact with a small "blob" of solder which has previously been placed with some powdered resin or fluxite in an old

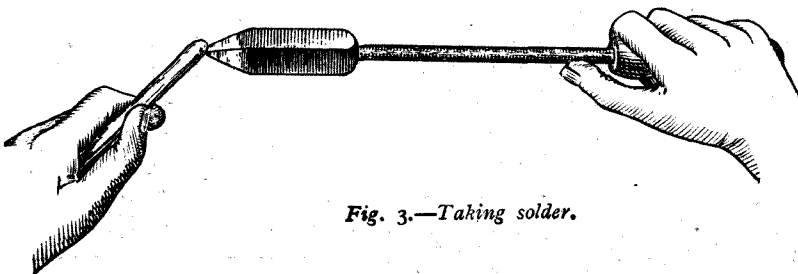
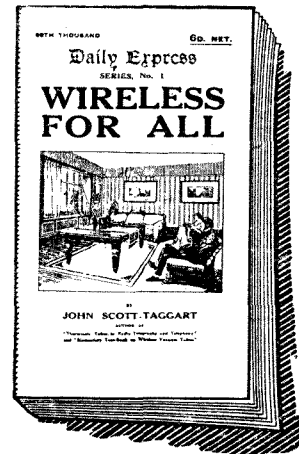

Fig. 3.—Taking solder.



## Every beginner needs this Book.

THIS is the most famous little book ever written on Wireless—thousands upon thousands have been sold since it was first published a little over twelve months ago.

It is safe to say that no other book has been the means of explaining the mysteries of Wireless to so many people. Old or young, all need this little book when taking up Wireless, because it treats the subject so tully. The author—John Scott Taggart, F.Inst.P., is a recognised Wireless authority, and he has certainly succeeded in presenting a somewhat difficult technical subject in a most readable and bright manner.

### Contents—

How to Tell what Station is Working—How Wireless Signals are actually sent—Light and Wireless waves Compared—Meaning of Wavelength—How Wireless Waves are Set up and Detected—How Wireless Stations work at the same time without interfering with each other—Does Weather affect Wireless?—Waves from a Wireless Telephone Station—General Notes on Different Kinds of Waves Received—How a Wireless Receiver Detects Waves—The Aerial—The Earth Connection—How a Wireless Set is Tuned to a Certain Wavelength—The Variable Condenser—The Crystal Detector—The Complete Wireless Receiving Circuit—Special Tuning Arrangements—How a Valve Works.

From all Booksellers, or 7½d. post free direct:

RADIO PRESS, LTD.,  
DEVEREUX COURT,  
STRAND, W.C. 2

Radio Press Wireless Library No. 1.

# 6<sup>D</sup>

tin lid (Fig. 2). Work the iron about until each face of its point is covered, as shown in Fig. 1, with a thin coating of solder.

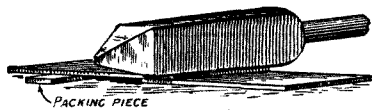

Fig. 4.—Sweating a joint.

The iron is now "tinned," and this coating must never be burnt off by overheating it. Should the tinning be removed accidentally it must be replaced before the iron is used.

We are now ready to begin to practise soldering. Our first job will be to tin a small piece of sheet brass. It is essential to remember that solder will stick only to surfaces that are absolutely free from dirt or oxide. We must therefore

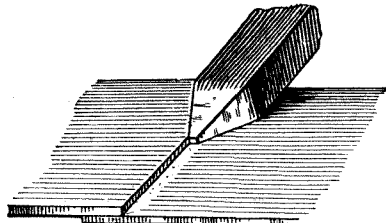

Fig. 5.—Soldering a joint.

clean the part to be tinned with fine emery-cloth until it is perfectly bright. This is one of the most important points in soldering. It is very frequently neglected, with the result that joints are badly made and give unexpectedly when any strain is placed on them. Lay the clean brass upon a folded newspaper on the bench and brush it over with a little fluxite.

Heat the iron. These three words sound simple enough, but there is a good deal in them. In the first place the iron must be heated in a clean flame—a gas-ring does very well indeed. Secondly, it must be hot enough and yet not too hot. Most beginners make the mistake of trying to use too cool an iron. A very good indication can be obtained from the appearance of the gas flame. The iron will be about right when vivid bluish or greenish flames appear round the copper. It should just singe a piece of rag when laid upon it for an instant. But it should not be anything like red hot or the tin on its point will be burnt off. When properly

heated the iron should make solder flow at once when its point is pressed against the stick. If the iron is too hot the solder will not remain upon its point but will run off immediately and fall on to the paper below in little balls. The solder used for wireless work should be of the blow-pipe variety, which is sold in tinned sticks.

Take a little solder from the stick with the point of the iron, as shown in Fig. 3, then apply it

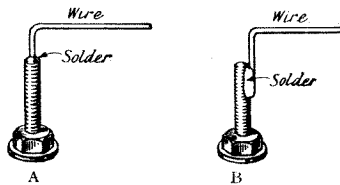

Fig. 6.—(a) First way of soldering wires. (b) Second way.

to the surface of the brass in this way; lay the point of the iron upon the brass for a moment in order to heat the latter to the right temperature, for solder will not stick to cold metal. Then move the iron slowly over the surface and solder will flow on quite easily to form a thin coating. Once you can tin a piece of brass or copper evenly and without making blobs and lumps you have broken the

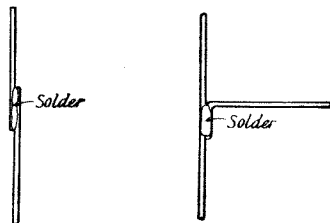

Fig. 7.—Joining wires.

back of the job of learning how to solder. Practise it until you can.

Our next step will be to make a joint between two pieces of sheet brass. To do this we first of all clean and tin the surfaces of the joint. We then apply a little more fluxite and place the tinned portions together. Next we heat the iron rather hotter than before and press it on to the joint (Fig. 4.) This heat causes the solder of the tinned surfaces to flow, and a very strong, tight joint results. This process is called "sweating." It can also be done by holding the tinned surfaces together with pliers and directing the flame of a blow-pipe on to the joint until the solder runs.

## Buy the Boy a Wireless Set for Christmas

Every boy would like to construct his own Wireless Set. Our famous Home Assembly Wireless Receiving Sets are ideal for this purpose.

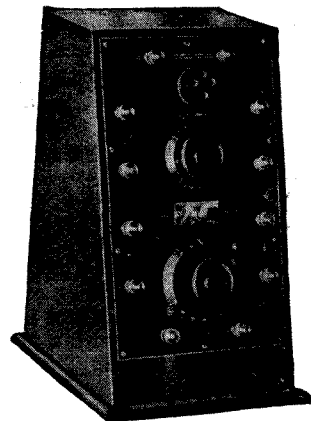

M.H.1.

- M.H.1. Single Valve Receiver £3 7 6
  - M.H.2. Two Valve Receiver £4 10 0
  - M.H.3. Three Valve Receiver £7 7 0
  - M.H.2a. Single Valve Amplifier £3 7 6
  - M.H.2b. Two Valve Amplifier £4 15 0
- Also four valve sets and tuners.

A large selection of Complete broadcast receiving sets and accessories, also components for the Home Constructor. Complete Catalogue, post free, 1/8.

## L. McMichael, Ltd.,

in conjunction with B. HESKETH, Ltd., Hastings House, Norfolk Street, Strand, London, W.C.2.  
Retail Showroom: Radio Corner, 179, Strand, London, W.C.2.  
5, Yelverton Road, Bournemouth



If for any reason we do not wish to make a sweated joint we can make a fairly strong one by laying the two pieces together and working the solder into their edges, as shown in Fig. 5. In this case the iron is moved slowly along, care being taken not to let it deposit too much solder.

It is a great mistake to suppose that you must use a great deal of solder to make a strong joint. As a matter of fact the less you use within reason the more secure will the joint be, for a thin coating sticks very firmly indeed, whilst blobs or lumps are easily pulled off as you can discover for yourself by actual experiment.

Practise tinning and jointing until you can do both jobs quite easily and until you have "got the feel" of the soldering-iron and can make its point go exactly where you want it to. You are then ready to tackle any ordinary wireless job.

The first of these that we will take is the attachment of a wire to a valve leg or the shank of a terminal. To make matters easy tinned wire should always be used. When you are removing the insulation take care not to remove the tin at the same time. There are two ways of making this joint and the first of which is seen in Fig. 6 (A). Give the end of the screwed shank a rub with a fine file and touch it with fluxite. Then using a pretty hot iron put a blob of solder on to it. The reason for using a hot iron is that with it the solder flows and sticks instantly. If a coolish iron is used one may be some time in getting the solder to stick, which means that the terminal is heated up and the ebonite into which it passes is partly melted. When this happens the insulating properties of the ebonite are lessened.

Now hold your wire in the left hand and the iron in the right. Place the end of the wire on the blob of solder and make it run with the iron. The wire will sink in, and when the solder cools will be firmly fixed.

The second method is shown in Fig. 6 (B). This has much to recommend it, for it is easy to do and makes a very secure job. Clean about one-third of an inch of the end of the shank with fine emery-paper and dress with fluxite. Lay the wire, also touched with fluxite, parallel with the shank and run

solder in between the two quickly with a hot iron.

When fluxite is used the hot iron makes it splutter a little so that it splashes on to the ebonite. As it is a moderately good conductor all these splashes must be carefully removed with a piece of rag, otherwise the insulation of the panel will be considerably reduced in the neighbourhood of soldered joints. Be careful to remove with a stiff brush any scraps of metal or emery that may have resulted from the operation of cleaning.

So far we have not made any use of the hollow which was filed in one of the faces of the soldering-iron. This should be tinned as before, and a blob of solder about the size of a pea should be allowed to melt in it. It will be found most useful when you have to deal with flex wire. When tinning the ends of a piece of flex first of all clean them up by scraping gently, then apply a very little fluxite. Twist them tightly together and place for a moment in the hollow in the heated iron. Solder will run in between them and will bond them firmly together into one compact whole. Treated in this way flex is as easy to solder as is plain wire.

We now come to the only other job that is likely to occur commonly in simple wireless construction. This is to solder two wires together. Fig. 7 shows how it is done. The ends of the portions to be tinned are laid parallel for about  $\frac{1}{2}$  inch and solder is run in between them. If the wires are very thin the joint can be made very easily by laying them side by side in the solder filled hollow of the iron. This same hollow will be found most useful for tinning the ends of untinned plain wires.

In conclusion do not try actual constructional jobs that require soldering until you have had a little practice with pieces of scrap brass and odds and ends of wire. Begin with a short light iron and and go on later to one of larger size. Keep the point of your iron trimmed up in case it show signs of pitting and see always that it is well tinned. Get your iron hot enough, and if it becomes at all dirty in the flame wipe it with a piece of rag before using it. Lastly, always use a flux, but do not use more of it than you can help, otherwise your work may be rather messy.

**"CATSEYE" CRYSTAL DETECTOR**

Ever-set and ready. Smallest. Loudest, Latest. Complete with holder 1/6 post free. A.P.A.L.L., 37, Red Lion Street, LONDON, W.C. 2.



Agents Wanted

**RESERVOIR CONDENSERS.**

3Mf can be used as 1Mf, 2Mf or 3Mf. All tested before despatch 3/6. Ex Gov. Microphones (Inset type) 2/6. Other Lines in stock. C. S. SWAN, 191, BISHOPSGATE, E.C. Under Brandouts, 14/0rs.

**EBONITE PANELS**

Cut to any size required in high grade, easily worked material:  $\frac{3}{8}$  in. thick, 1d. per sq. in.;  $\frac{1}{2}$  in. thick, 1d. per sq. in. Mail Orders:—Add 6d. towards cost of packing and post. Panels drilled and/or engraved to your own paper pattern. It is cheaper than buying drills. Estimates free. Phone: Regent 3335.

**OMNIPHONE WIRELESS CO.,**  
24, Warwick Street, Regent St., London, W.1.

**A Marvellous Wireless Patent WILLESFORD'S MULTI-POINTED CAT'S-WHISKER**

Makes Crystal Set as h.u. and better toned than valve set. No trouble finding points. At all retailers 1s. or 6 pos. P.O. 1s. 2d. Buying Agents Wanted. WILLESFORD'S, 20/1, Buckingham Street, Strand, London, W.C. 2.

**THE SENSATION OF THE SHOW THE T.C.B. RESISTANCES**

(Reg. No. 699657).

**4/-**

We are making a special Rheostat with a resistance of 30 ohms for the new type of Dull Emitter Valve. Ask your Dealer to show them to you or write direct to

**T. C. BALL,**  
39, Windsor Rd., Ealing, W.5.

**2 in. x 2 in.**

**£3 10 0**

**per insertion.**

# Perfect Results Assured by Using "IGRANIC" RADIO DEVICES

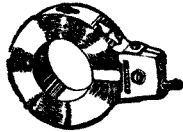

### IGRANIC HONEYCOMB COILS. (De Forest Pat. No. 141344.)

These world-famous coils are renowned for their high efficiency, low self-capacity, small absorption factor and minimum high-frequency resistance. No dead-end losses. Each turn surrounded by air pocket. Made in two types, gimbal and plug mounted. Wavelengths approximately 100 to 25,000 metres. The only coils that uphold their claim for negligible losses. Prices vary with sizes.

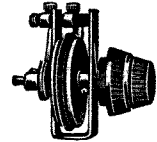
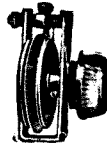

### FILAMENT RHEOSTATS. (Patent No. 195903.)

A splendid instrument for filament control under all conditions: Novel method of construction ensures smooth and silent operation: Designed for individual valve control. Adjustable contact fingers. Permits of resistance values from zero to 4 ohms by fine variation. Supplied in two types, plain and vernier.

PRICES : Plain, 4/6 Vernier, 7/-

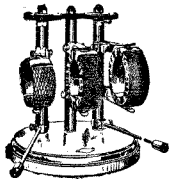

### GIMBOLDER TUNING STAND. (Patent Applied for.)

This coil holder has been designed and produced for accommodating gimbal-mounted Honeycomb Coils, which enable extremely fine settings to be obtained. In addition to the angular relation of the coils being varied, they can also be rotated about their own axis, thus giving extremely fine and critical adjustment when used on selective and regenerative circuits.

### INTERVALVE TRANSFORMERS. (Patent No. 205013.)

Correctly designed for minimum distributed capacity. Low core losses. Coil wound by patent cotton interweave process. Maximum amplification without distortion.

PRICES : Open Type, 20/- Shrouded Type, 21/-

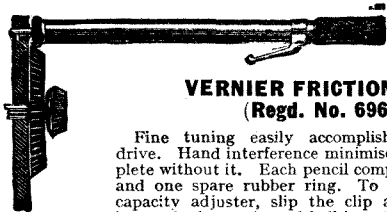
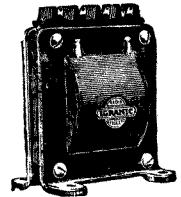

### VERNIER FRICTION PENCIL. (Regd. No. 696394.)

Fine tuning easily accomplished. Positive friction drive. Hand interference minimised. No radio set complete without it. Each pencil complete with three bushes and one spare rubber ring. To convert into an anti-capacity adjuster, slip the clip attachment down and insert the brass pin and ball into two holes drilled in the knob.

PRICE 2/-

### BATTERY POTENTIOMETER.

An Igranic Potentiometer is a necessity where one or more stages of high-frequency amplification is used. Stabilises grid and eliminates noises and self-oscillation. Resistance 300 ohms. Current consumption negligible. Nickelled finish, complete with fixing screws, knob and pointer.

PRICE 7/-

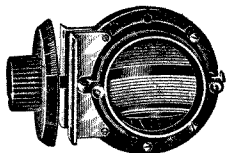
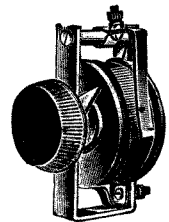

### TYPE "H" VARIOMETER.

Recommended for use in the aerial circuit of crystal and valve sets. Wavelengths range approximately 150-600 metres with P.M.G. standard aerial. Stator and rotor best quality mouldings, windings and self-supporting and impregnated solid.

PRICE, with Knob, Dial and Fixing Bracket, 15/-

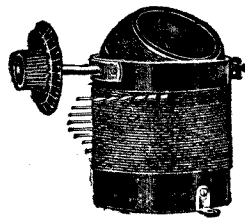

### TYPE "H.R." VARIOCOUPLER.

Stator and rotor of hard moulded insulation, and windings impregnated solid. Tappings on primary enable fine tuning to be obtained, thus eliminating condenser. Coupling continuously variable over wide range.

PRICE, with Knob, Dial and Fixing Brackets, 19/-

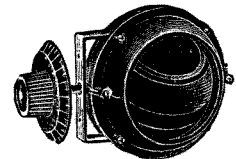

### TYPE "S.R." VARIOMETER.

Designed for secondary and tuned anode circuits. Wavelengths 150 to 600 metres approximately. Similar to Type "H," but with larger winding. Moulded insulation and windings impregnated solid.

PRICE 18/-

OBTAINABLE FROM ALL HIGH-CLASS DEALERS

WRITE FOR LISTS Z122.

Manchester : 30, Cross Street.  
Birmingham : 73/4, Exchange Buildings,  
New Street.  
Glasgow : 50, Wellington Street.  
149, Queen Victoria Street,  
LONDON.



Cardiff : Western Mail Chambers.  
Bradford : 18, Woodview Terrace, Manning-  
ham.  
Newcastle : 90, Pilgrim Street.  
Works :  
Elstow Road, BEDFORD.



## BUILD a Xmas Gift for your Family

Get that wonderful feeling of pride and pleasure when they shower thanks and congratulations upon you for the fine, year-round means of entertainment provided by a Polar Blok set.

With your own hands and without technical knowledge, engineering skill, or any tools other than pliers and a screw-driver, you can build a perfect receiving installation on the

# POLAR BLOK

## System of Wireless Set Construction

Using Polar Blok leaflets for instruction you can begin with a Crystal or One Valve Set and extend at will, meanwhile preserving the finish of first-class workmanship and getting perfect reception.

Polar Blok is, in a sentence, the one great System whereby you can build, extend and experiment with standardised, inter-fitting framework sections, panels and components, purchased according to what your plans are.

The set you start with, though complete in itself, need not be your final endeavour. You will find wireless so interesting that extension will prove irresistible—especially when made so simple and so economical by Polar Blok.

Whether beginner or experimenter, the Polar Blok System places in your hands the better way of wireless—and the coupon below brings you full particulars for 5d in stamps.

**POST THIS TO-DAY**

**COUPON**

To **RADIO COMMUNICATION CO., LTD.,**  
34-35, Norfolk Street, Strand, W.C. 2.

Enclosed 5d. for Polar Blok Booklet and Leaflets showing various circuits.

NAME .....

ADDRESS .....

.....

FLEET AD. 69

**“Won't work a Polar Condenser”**

# POLAR CAM-VERNIER KNOB & DIAL

IF your condenser is a “Polar” you do not need this. (See special note.)

But if you are less fortunate in owning a condenser of any other type, *i.e.*, without the fine adjustment principles of the “Polar,” then the Cam-Vernier Knob and Dial offers advantages which you *really need*.

Fitted to the spindle of any ordinary condenser or other such device, it enables you to get a direct drive into any position, and at any point of the movement will permit a vernier adjustment over a 10° arc.

Thus we are providing, in principle, some “Polar” condenser advantages for those who already own other types.

Any Polar Stockist will supply you with the Polar Cam-Vernier Knob and Dial, guaranteed and backed by the great Polar reputation.

Price 7/6.

If unable to obtain, write direct, enclosing postage extra—6d.

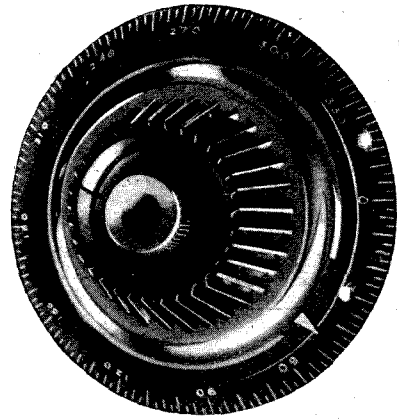

***Why you cannot  
—and need not  
use it on the  
POLAR CONDENSER***

The stiffness of the spindle on the condenser prevents the use of the Cam Vernier Knob and Dial on the Polar Condenser, but—

The Polar Condenser is so arranged that a vernier scale is provided at the section where most used, so that additional appliances are superfluous.

The “Polar” is the world's best condenser, in which the first quarter of the scale contains only one-tenth of the total capacity.

Supplied in capacities as follows—

.001; .0002; .0003; .0005.

Price: Unmounted, 14/-;  
Mounted, 20/-.

## RADIO COMMUNICATION COMPANY, Ltd.,

34/35, Norfolk Street, Strand,

LONDON, W.C.2.

Telephone  
CENTRAL 8480.

Telegrams  
RADIOCOMO, ESTRAND, LONDON.

# T. O. BUSS, Scientific Instrument Maker,

77, CLERKENWELL ROAD, LONDON, E.C.1.

Established 1850.

Exhibition Awards—London 1862. Sydney 1879. Melbourne 1880.

## HEADPHONES 14/11

Genuine French Telephones, most sensitive obtainable, 4,000 ohms with cords (Double Receivers) ... post free

"BRUNET" Headphones, 4,000 ohms. 16/6  
post 9d. extra.

Side, 4,000 ohms. 14/11  
Side, 8,000 ohms. 17/11  
B.B.C. PREMIER, 4,000 ohms. 17/6

### VALVES.

Cosser .. 13/-  
Cosser P2 .. 13/-  
Marconi "R" each .. 10/-  
Marconi V24 14/-  
Ediswan .. 13/-  
Mullard Ora .. 13/-  
French "R" .. 10/-  
Dull Emitter D.E.R. 24/6

Postage on Valves, 9d. extra.

CONDENSERS. Complete Sets of Parts.			Assembled Complete for Cabinet Mounting.		
Approx. Capacity Microf'ds.	No. of Plates.	Price.	Approx. Capacity Microf'ds.	Price.	
.001	57	6/6	.001	7/6	
.00075	43	5/9	.0005	5/11	
.0005	29	4/11	.0003	5/2	
.0003	19	4/2	.0002	4/6	
.0002	13	3/6	.0001	4/-	
.0001	7	3/-			

FIXED CONDENSERS, .0003, .0005, .002, .003, 10d. and 1/- each. .004, 1/6 each. Post. 3d.  
VARIABLE GRID LEAK, 2/- each and 6/- each.  
GRID LEAK AND CONDENSER, .0003, 2/6 each. 100,000 ohms Resistance, 2/- each. Postage on above, 3d. each.

## WIRELESS PARTS AND ACCESSORIES.

Aerial Wire, 7/22 bare copper, stranded. Price per 100 ft., 2/6 and 2/4. By Post, 3/6.  
Aluminium Vanes, 1 doz., 5d. By Post, 8d.  
Basket Coils, 7 in. set, 3/- set. By Post, 3/4.  
Brass Washers, 2, 3, 4 or 5 B.A. ... dozen 2d.  
" Nuts, 2 B.A. ... dozen 2d.  
" Nuts, 3, 4 or 5 B.A. ... dozen 2d.  
" Rod (screwed)—  
2 B.A., in 12-in. lengths ... each 3d.  
3 B.A., in 12-in. lengths ... each 3d.  
4 B.A., in 12-in. lengths ... each 2d.  
Contact Studs, 1/2 in. by 1/4 in., complete with nut and washer, 5d. doz.  
Copper Foil Sheets, uniform thickness, 12 in. by 3 in. 3d. each.  
Crystal Detectors on Ebonite 1/6 each.  
Crystal Detector, cup enclosed with glass cover, dust proof, 3/6. By Post, 4/-.  
Coil Holders, Ebonite, 3-way, 5/6, 6/6, 7/6; 2-way, 4/6 and 5/6. Post any one, 6d. extra.  
Ebonite Dials, with engraved scale 0-180, 1/- each. By post, 1/6.  
Engraved Ivorine Scales, 0-180 round ends. 4d. ea.  
Filament Resistance, 1/6, 2/6 each. By Post, 1/10 and 2/10.  
Inductance Coils Wound Enamel Wire, 12 by 4, 3/- By post, 5/-.  
1 1/2 Insulating Steeving, 4d. yd. By post 4/- doz. yds.  
Insulators, Egg, 4 for 11d., 2/6 per doz. By post, 3/6 doz.  
Insulators, Reel, 1 1/2 d. each. By post, 6d. doz. extra.  
Knobs, with brass nut (2 B.A.), 3d. each. By post, 3 1/2 d.  
Large Spacer Washers, 3 doz., 9d. By post, 1/-.  
Lead-in Tubes, ebonite with brass terminals, 9 in., 1/- By post, 1/4. 12 in., 1/4. By post, 1/8.  
Slider and Plunger, 4d. By post, 6d.  
Slider Knob, Plunger and 13 in. rod, 8d. the set. Cannot be sent by post.  
Small Spacer Washers 6 doz. 1/- By post, 1/4.  
Spade Terminals, 4d. doz. Post 1 1/2 d.  
Switch Arms, with polished knob, bushed 2 B.A. nut, laminated blade, spring coil washer, nuts and bush, 1/- and 1/6 each. By post, 1/3 and 1/9.  
Tin Foil, free from lead. Sheets, 17 in. by 11 in., 4d. each.  
Valve Legs, with nuts and washers, 1d. each, 9d. doz.  
Valve Holders ebonite, complete with nuts, 1/-.  
Valve Pins, 7d. doz.

## Terminals.

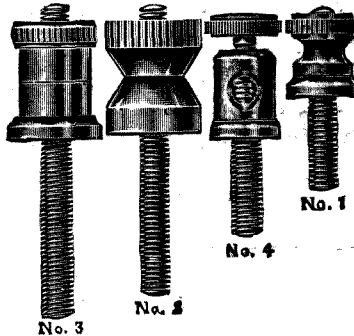

No. 3 Terminals, 2 B.A., with nut and washer, 2/- doz. By post, 2/6.  
No. 2 Terminals, War Office Pattern, with nut and washer, 1/3 doz. Post, 1/9.  
No. 4 Terminals, Telephone, with nut and washer, 1/3 doz. By post, 1/9.  
No. 1 Terminals, with nut and washer, 1/- doz. By post, 1/6.  
Terminals (large), aerial and earth, complete with 2 nuts and 2 washers (2 B.A.), 2 for 8d. By post, 1/-.

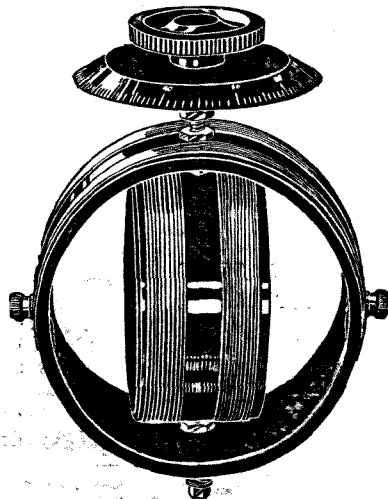

## VARIOMETERS.

Bushed Bearings, Ebonite Dial 0-100, and Knobs. Metal Parts Plated. Wave-length 250 to 560 metres.

Possessing high insulating properties, and the finish of the instrument throughout is excellent.

Adequate provision is made for mounting on a panel, and the dial is neatly and clearly engraved.

A variable condenser of .0005 microfarad capacity in series of parallel for the short and longer wavelengths respectively.

Marvellous Price 4s. 6d.

Post 6d. extra.

## "EBONITE"

Postage free. Any size cut.

	s. d.	£ s. d.
8x1x1/2	7	12x10x1/2
4x4x1/2	1 3	17x8x1/2
7x6x1/2	2 8	18x18x1/2
10x6x1/2	3 9	36x18x1/2
17x5x1/2	5 3	

Post free.

## Instrument Wires

British Made Copper Wires

Prices per lb.

Other sizes in stock. A charge of 3d. extra is made for reeling off in small quantities. Postage extra.

S.W.G.	yds. per lb.	ohms. 1,000 yds.	S.C.C.	D.C.C.	S.S.C.	D.S.C.	Enm/d.
22	140	39	2/9	3/-	4/6	5/-	2/7
24	230	63	3/-	3/6	4/6	6/-	2/8
26	340	95	3/7	4/1	5/-	8/-	3/2
28	530	140	4/4	4/8	6/-	9/-	3/6
30	716	200	5/-	5/6	7/-	10/-	3/10
32	950	262	6/-	7/3	8/-	12/6	4/2
34	1,300	362	7/-	8/3	9/-	13/6	4/4
36	2,000	530	8/8	10/-	12/-	15/6	4/8

## Wireless Crystals

"Hertzite" Shaw's 1/-  
Zincite 9d.  
Silicon 6d.  
Bornite 6d.  
Copper Pyrites 6d.  
Wood's Metal 6d.  
Carborundum 6d.  
Molybdenite 6d.  
Iron Pyrites 6d.  
Galena 6d.  
Graphite 6d.  
Tellurium 1/-

Post free.

## Interval Transformers

"BUSS" TRANSFORMER, size 3x3x1 1/2. Ratio 5 to 1, 15/- Post free.  
POWKIP TRANSFORMER, 5 to 1 Ratio, 11/3. Post 6d. extra.  
H.F. VARIABLE TRANSFORMER, 5 Tappings, 300-3,000 metres, 14/6. Post 6d. extra.  
H.F. TRANSFORMER, Plug-in Type from 4/6. Post 4d. extra.

## Celluloid Accumulators

BEST BRITISH MAKE.

	Amp. Vols.	Amps. hrs. cont.	Igu.	Price.	Post.
Oldham	6	20	40	26/3	2/-
"	6	30	60	33/-	3/-
"	6	40	80	35/-	3/-
B.A.P.	4	20	40	15/9	1/-
"	4	30	60	29/6	2/-
M.A.L.	2	20	40	10/-	1/-

H.T. BATTERIES, 60 volt, 9/6 and 8/6. Post 1/3.  
" " 36 volt, 5/6 and 4/9. Post 1/1-  
Including Wander Plugs.

## Inductance Tubes

Cardboard.

12x2 1/2, 4d. Post 2 1/2 d. 12x3 1/2, 6d. Post 4d.  
12x3, 5d. Post 3 1/2 d. 12x4, 8d. Post, 5 1/2 d.

## Mahogany Boxes

Polished. Post.  
4 1/2 x 4 1/2 x 3 1/2 in. ... 2/9 3d.  
4 1/2 x 4 1/2 x 5 in. ... 3/3 6d.  
6 1/2 x 6 1/2 x 4 in. ... 4/6 1/-  
13 x 6 1/2 x 4 in. ... 7/- 1/-

Any size and shape to order. Price on application.

TRADE SUPPLIED.

Terms on Application.



# The B.T.H. "Bijou" Crystal Receiver

G.P.O. Regd. No. 861

**T**HE B.T.H. MONOGRAM is an assurance of supreme quality, workmanship and design. All units before leaving our works must pass the most searching tests to ensure that only apparatus that is perfect in every respect is offered for sale.

The new B.T.H. "BIJOU" Crystal Set has been specially designed to meet the demand for an efficient and well-finished receiving instrument at a moderate price. Tuning is effected by means of a variometer which, apart from its ease of manipulation, is perfectly silent in action. On the inside of the lid are pasted full instructions for use, and a list of approximate settings to facilitate rapid tuning. Telephony can be perfectly received within a radius of 20 miles, and under favourable conditions much longer distances can be covered. One set of B.T.H. 4,000 ohm resistance head telephones for use with this receiver is supplied. The 'phones are efficient and comfortable and reproduce both speech and music without distortion.



**Price**  
with one set of  
B.T.H. Headphones  
(including B.B.C. tax)  
**£3 . 11 . 0**

The apparatus is enclosed in a polished walnut case with hinged lid, the external dimensions being 7" x 5 $\frac{1}{4}$ " x 4 $\frac{3}{4}$ ". All metal parts are brightly nickelled.

## The British Thomson-Houston Co. Ltd

(Wholesale Only)

Works RUGBY

London Office CROWN HOUSE, ALDWYCH

Sole Agents for the Music and Gramophone Trades :

THE MURDOCH TRADING COMPANY, 59 & 61 Clerkenwell Rd., London

1967



## Get the Best from Your Set

**T**HE "M-L" Twin-Coil Intervalve Transformer will give you the best possible results from your set.

Signals will come in with great strength and without that distortion so detrimental to good reception.

Stoutly built, it is perfectly insulated and proof against dust and damp.

It possesses high primary inductance combined with very low self capacity and does not distort even when the Anode Voltage is raised.

The following is an extract from a letter we have received from a satisfied user:—

"I am more than pleased with the results. The greatly improved reception since fitting these transformers is indeed amazing. . . ."

*We invite applications from traders for terms.*

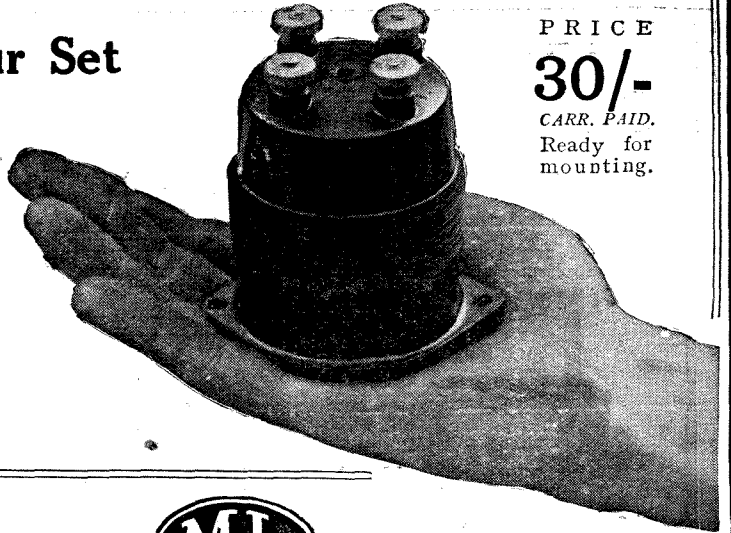

PRICE  
**30/-**  
CARR. PAID.  
Ready for mounting.

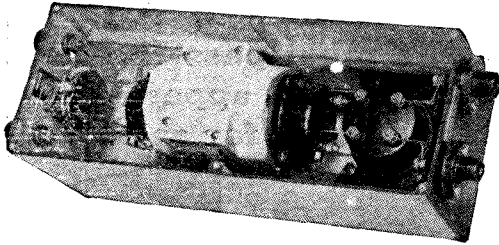

## The Anode Converter

THIS unit has been specially designed to meet the demand for a reliable substitute for the high-tension battery. It is especially useful in connection with power amplifier work where a considerable plate current is taken at a high voltage. Worked from the ordinary 6 volt accumulator of your set, the consumption is only 1.15 amperes. Reception is perfectly smooth without any of those parasitic noises so often due to faulty high-tension batteries.

Supplied in the following standard voltage ranges:—  
Type "A" 6-70 volts—for general reception.  
Type "B" 6-120 volts—For two stage power amplification.  
Type "C" 12-300 volts— " " " "

Write for full particulars: THE M-L MAGNETO SYND., LTD., WIRELESS DEPT., COVENTRY.

**"HAVE A GOOD ONE"**

# Have you compared

the range of wavelengths obtained on the coils you are using with that given by "Efficiency Coils"? If you do so you will find that "Efficiency Coils" give approximately 50 per cent. greater range. There is nothing mysterious about this. It is merely due to scientific design and construction which reduces self capacity to a negligible quantity. Besides this advantage these coils are mechanically very strong and are the same size for all wavelengths. Reckoning on a cost per metre basis they are **CHEAPER THAN OTHERS.**

Coil.	Wavelength range shunted with .001 capacity condenser.	Self capacity in Microfarads.	Price.
a	75 ...	325	.000074 5/9
A	120 ...	525	.000004 5/9
B	200 ...	855	.000005 6/-
C	285 ...	1200	.000006 6/9
D	400 ...	1700	.000006 8/-
E	600 ...	2875	.000008 9/6
F	1040 ...	4350	.000079 10/3
G	1575 ...	6800	.000011 12/-
H	2250 ...	9500	.000014 14/-
I	4300 ...	18000	.000017 16/-
J	6400 ...	27000	.000021 19/-

White for full particulars or call at our London Office:

**76, Victoria Street, S.W. 1.** (Entrance in Palace Street.)

Phone: Victoria 9938.

WORKS: MERTON ROAD, SOUTHFIELDS, S.W. 18.

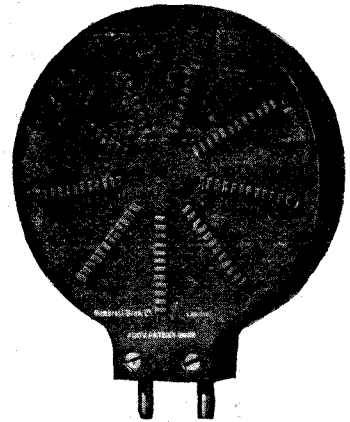

Supplied with either double plug or standard plug 7 socket fittings.

# Gambrell Bros., Ltd.

# Silvertown

## WIRELESS ACCESSORIES.

FOR more than 50 years we have been manufacturing Electrical Apparatus, a period of experience that guarantees consistently high quality in our Wireless Accessories. There can be no better assurance of reliability than the name "Silvertown."

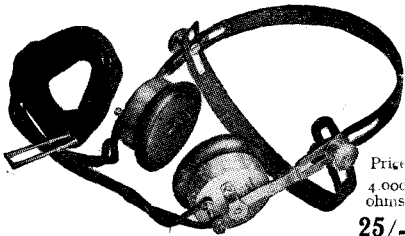

Price  
4,000  
ohms  
25/-

**SILVERTOWN TELEPHONE HEADPIECES.**  
The "Stalloy" diaphragms are made so as to secure a balance of tone and quality. Light and comfortable, highly sensitive, easily adjusted, first class workmanship and finish. Resistance 120, 2,000, 4,000, 8,000 and 12,000 ohms.

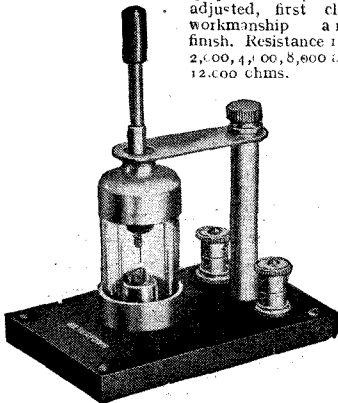

**CRYSTAL HOLDERS.**

Mounted on ebonite base 3 in. by 2 in. with glass to protect crystals from dust. A feature of this crystal holder is that it can be easily taken to pieces and set up again. Price 4/6 each.

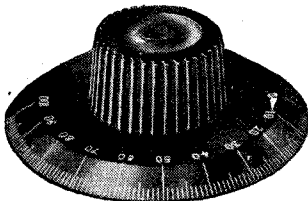

**EBONITE CONDENSER DIALS AND KNOBS.**

In one piece, graduated in white 0-100 or 0-180, highly finished. Complete with fixing screw. Dial approximately 3 in. diameter. Price complete, 1/3 each. Dials only 10d. each.

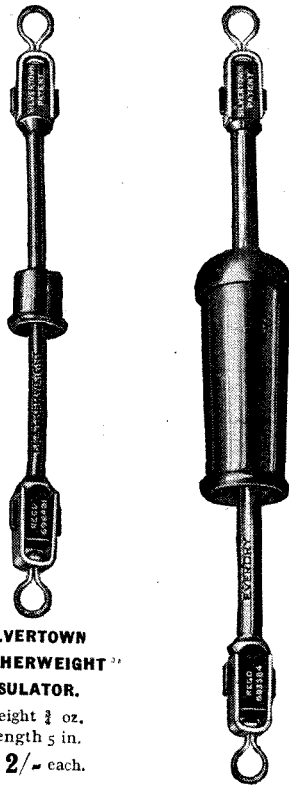

**SILVERTOWN "FEATHERWEIGHT" INSULATOR.**

Weight 3/4 oz.  
Length 5 in.  
Price 2/- each.

Small in diameter, small area for surface leakage. Cup in centre keeps a portion of the insulator dry in wet weather.

**SILVERTOWN "EVER-DRY" INSULATOR.**

Weight 2 1/2 oz.  
Length 7 in.  
Price 3/- each.

Ends are made of Duralumin, to reduce weight. Electrical efficiency is superior to that of a number of porcelain insulators in series. The "capacity" effect of Silvertown Insulators is very small.

These are the best and most effective insulators ever devised.

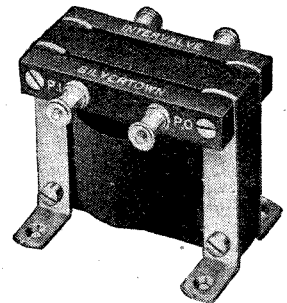

**SILVERTOWN INTERVAL TRANSFORMERS.**

Tested 1,000 volts between windings and 2,000 volts between winding and frame. 2 1/2 in. high by 3 1/4 in. wide by 2 1/2 in. deep overall. Weighs 1 lb. 3 1/2 oz. Price 21/- each.

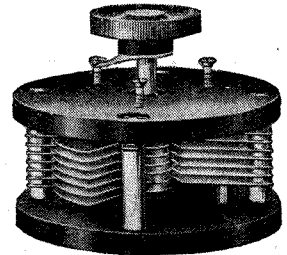

**SILVERTOWN VARIABLE CONDENSERS (for panel mounting).**

Capacities 0.0001, 0.0002, 0.0005, and 0.001 mfd. Moving vanes are shaped to give low minimum capacity. These condensers are fitted with a stop to allow of a movement of 180 degrees only. Prices 7/6, 8/-, 11/6 & 15/- each.

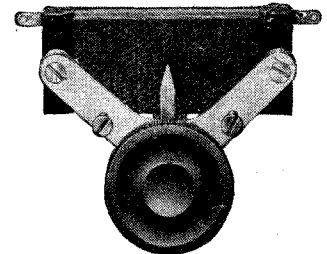

**SILVERTOWN POTENTIOMETERS (for panel mounting).**

On rectangular ebonite former, complete with knob and pointer. Former mounted on cast brass frame. Resistance approximately 400 ohms. Price 7/6 each.

Silvertown Accessories are obtainable of all dealers. When buying Wireless Accessories specify Silvertown and be sure of having the best.

**MAKERS—The Silvertown Company, 106, Cannon Street, London, E.C.4.**

# R.F. GRAHAM & CO.

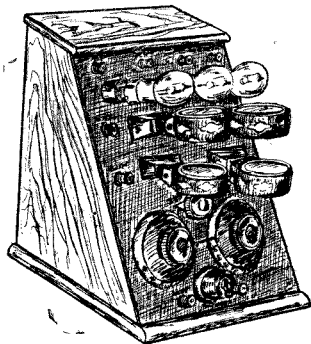

## 3 - VALVE Concert Receiver,

with many other possibilities on all wavelengths. (See Catalogue.)

Receives all Broadcasting and Continental Stations with an Indoor Aerial.

Simple to operate, and the purity of tone is a delight.

American Stations can be heard under favourable conditions.

An Ideal "Xmas" Present and an Ideal Instrument.

£10

(Mahogany Cabinet.)

B.B.C. Tax £1 2s. 6d., and Marconi's Royalties £1 17s. 6d.,

The following accessories, namely:—3 Valves; 1 Loud-Speaker; 1 Pair of 4,000 ohms Headphones; 4 Concert Coils; 60-volt H.T. Battery; 4-volt Accumulator, 40 actual ampere-hour capacity; 100 ft. 7/22 S.W.G. Copper Aerial Wire; 2 Insulators; 30 ft. Insulated Lead-in and Earth Wire; 1 Lead-in Tube and 1 Earth Pipe Clip are supplied for £10 extra. So that £20 gets you the best complete outfit and best possible results, which cost less than 1d. an hour for enjoyment, and all taxes, etc., paid.

## R. F. GRAHAM & CO.,

Manufacturers,

Norbition Works, Cambridge Rd., Kingston-on-Thames.

ENQUIRIES at Offices, 101, Gloucester Road, Norbition, where sets are demonstrated during broadcasting hours by appointment.

TRADE: Please quote for parts and accessories.

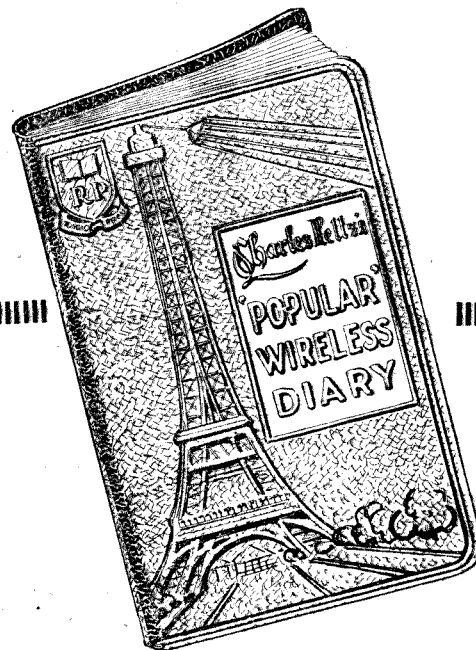

# Radio Press Diaries for 1924

FOR your appointments—to chronicle your doings—for the thousand and one things connected with your life, you need a Diary.

This year purchase a Wireless Diary and get some useful information without extra cost.

These two Radio Press Diaries are both extremely neat and well-produced little Books. They do everything that a Diary should do—they are convenient in size and shape—do not bulge the pocket—strongly bound to give a whole year's service, and more besides, if needed. Just the Diary, in fact, to suit the most critical. From all Booksellers or direct (postage 2d. extra) from Radio Press, Ltd.

## Radio Press Handbook and Diary for 1924.

Size 5½ in. by 3½ in., solidly bound in grained leather cloth, fitted with pencil. Diary portion shows a whole week at an opening. Large number of pages of technical data, including several pages of electrical formulae which will prove invaluable to the serious worker. . . . 2/6

## Radio Press Popular Wireless Diary for 1924.

Size 2½ in. by 4½ in. Strongly bound in leather cloth with rounded corners. One complete week shown at each opening. Wireless pages include information on call signs, circuit diagrams, Morse Code, electrical data, full instructions for building a complete Receiving Set, etc., etc. . . . 1/-

In Leather, with pencil 1/6

# Wireless Map of Great Britain

THIS new map has been prepared under expert supervision, and gives the following useful information:—

All places with transmitting apparatus are shown in black. Call signs applying to these in red. Broadcasting, Commercial, Aviation, and Amateur and Experimental Transmitting Stations are all indicated by special symbols, also in red. Admiralty, Naval and Trinity House Stations specially shown in blue. A Complete Index to all Amateurs and Experimental Stations appears on the map, the origin of a call-sign being at once located by means of numbered squares. Diagrams with Compass bearings show the direction of important Overseas Stations in relation to different portions of the map. London and District: An inset map on an enlarged scale (1¼ miles to 1 in.) clearly shows the stations within this area.

### PRICES

On Paper folded in Cover . . . . . 2/6 net, postage 2d.  
Mounted on cloth folded in Case . . . . . 5/6 net, postage 4d.  
Mounted on Cloth and Varnished, with Rollers . . . . . 7/6 net, postage 9d.

2/6

RADIO PRESS, Ltd., Devereux Court, STRAND, W.C.2.

# Exide

## The long life battery.

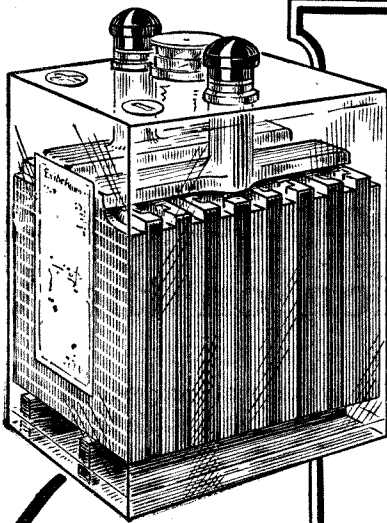

### H Z TYPE for Dull Emitter Valves.

The H Z Type Battery has been specially evolved to meet the requirements of Dull Emitter Valves.

It is specially suitable for long slow discharges, and need only be re-charged every six months, providing it is kept in use and not completely run down.

Type	Actual Capacity.	Price
H Z 2	40 amp. hours	£ s. d. 0 17 6
H Z 3	60 "	1 1 0
H Z 4	80 "	1 4 6

Obtainable from all dealers and Exide Service Agents.

ASK FOR LIST 4031.

**THE Chloride ELECTRICAL STORAGE COMPANY LIMITED.**

HEAD OFFICE & WORKS:

CLIFTON JUNCTION, NR. MANCHESTER.  
LONDON: 219-229, Shaftesbury Avenue, W.C.2.

BIRMINGHAM: 57-58, Dale End.

MANCHESTER: 1, Bridge Street.

We also illustrate below the B.K. and A.Y.G.1 types of High Tension Batteries.

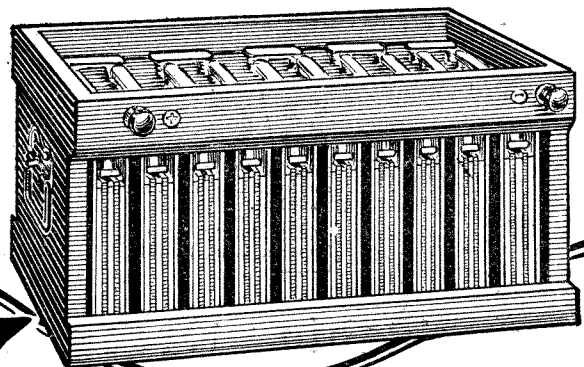
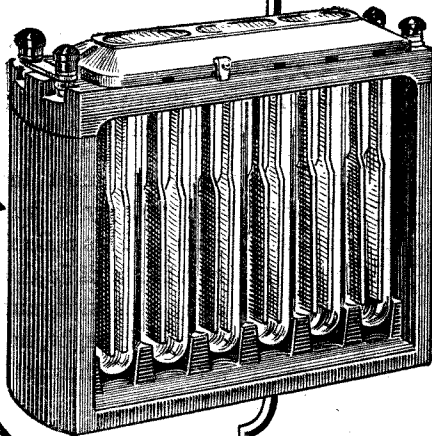

Use Chloride Batteries for House Lighting.

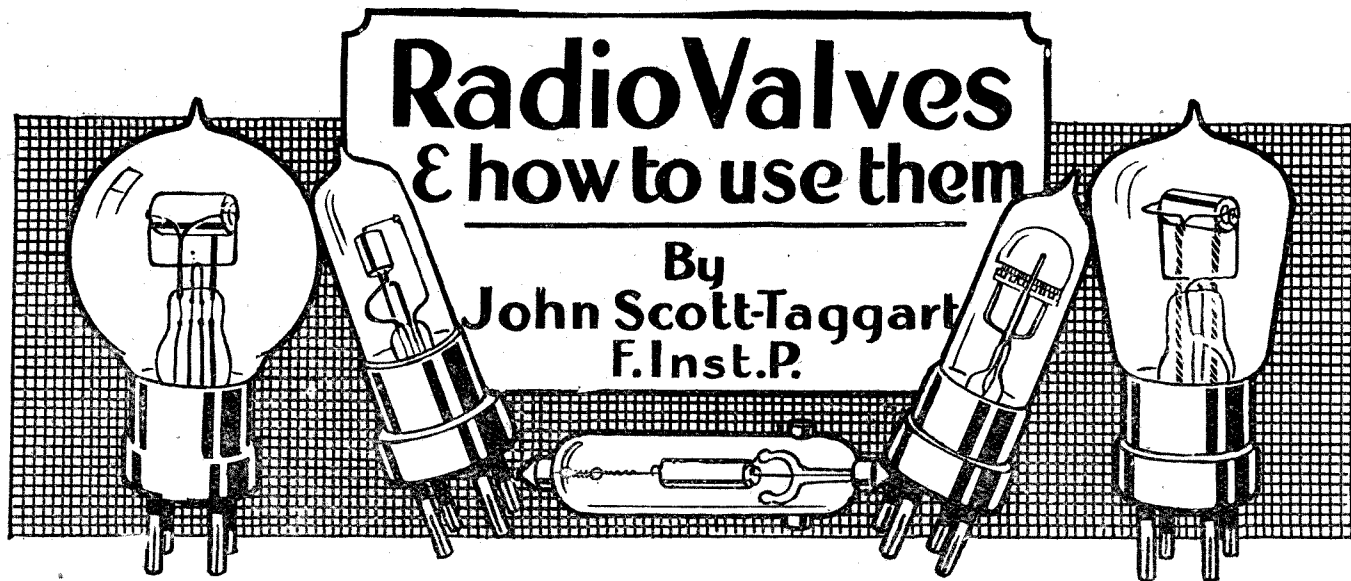

JUST  
PUBLISHED!

—a complete course of  
instruction on the Valve

Can you answer  
these questions fully ?

What is meant by Reactance-capacity coupling ?

Which is more selective—  
"Tuned Anode" or "Reactance capacity" for H.F. use ?

What is Reaction ?

What is meant by "Dual Amplification" ?

How is self-oscillation caused ?

What is an aperiodic transformer and its advantages ?

**2/6**

from all Booksellers, or  
2/8 post free direct from  
publishers.

RADIO PRESS, LTD.,  
Devereux Court, Strand,  
W.C. 2.

TO make real progress in Wireless you must be able to understand the principles of the Radio Valve. The importance of this cannot be emphasised too strongly.

While there are several Books on the Valve by the same author, none of them covers quite the same field as "*Radio Valves and how to use them.*"

This Book is rather more elementary in its appeal and should be extremely useful to those who are beginning to take a more serious interest in Wireless.

Its explanations are most lucid and graphically illustrated by a very large number of diagrams. It is a Book which, although dealing with a difficult subject, is most fascinating and intriguing in its appeal. A Book which ought, in fact, to be on every wireless enthusiast's book-shelf.

It is written from the point of view of the man who is going to *use* valves.

Radio Press Series No. 12.

# OVER A MILLION SATISFIED CUSTOMERS

# ELKAY WIRELESS CO.

Great Britain's Largest exclusive Wireless Stores

PIONEERS OF CHEAP PRICES

**Quality, Quantity and Consistency our Motto.**  
See our six-window display of bargains. *Wireless and Everything for it.*

**ELKAY** Lightweight Headphones, 4000 ohms, all guaranteed per pair **12/9** **N & K** (The Genuine Article), 4000 ohms, all guaranteed per pair **12/9**  
**FELLOWS** New Light Weight Phones, 4000 ohms, Stamped B.B.C. **18/6** **STERLING'S** Latest Model Headphones, 4000 ohms, Stamped B.B.C. **19/3**  
 Also **BROWN'S, BRUNET, Etc.**, at special reduced prices.

**VALVES** **MARCONI "R"** ..... **ALL ONE PRICE** EACH **11/10**  
**EDISWAN** ..... Special Packing and Postage, 1/- extra  
**MULLAND ORA** ..... Bankrupt stock and of limited quantity  
**COSSAR (Red or Plain Top)** .....  
**DULL EMITTER VALVES:** **MARCONI, EDISWAN, ALL ONE** { Packing and Postage 1/- extra each. **24/9**  
**MULLARD** } **PRICE** { Bankrupt Stock and of limited quantity

**LOUD SPEAKERS** Say what make you require **10% Reduction of STANDARD PRICES**

<b>DUTCH VALVES</b> .. . . . . 6/11 & 7/11	<b>FILAMENT RESISTANCES</b> , smooth action, marvellous value .. . . . 1/9	<b>COIL PLUGS</b> , real ebonite .. 1/3, 10½d., & 9½d.
<b>L.F. TRANSFORMERS</b> Ratio 5 to 1. All guaranteed (postage 1/-) .. . . . 11/3	With engraved dials .. . . . 2/6	<b>H.F. PLUG TYPE TRANSFORMER:</b>
<b>CRYSTAL DETECTORS</b> .. . . . 1/9, 1/3 & 10½d.	<b>FILAMENT COMPLETE CIRCLE RESISTANCE SCALES</b> , 0 to 300 .. . . . 6d.	1 .. . . . 250 to 600 metres .. . . . 3/9
<b>CRYSTAL DETECTORS</b> , enclosed in glass case .. . . . 2/6, 2/3, 1/6	<b>BELL WIRE</b> , tinned copper, 12 yds. .. . . . 6d.	2 .. . . . 350 to 700 .. . . . 4/-
<b>AERIAL WIRE</b> , 7/22, guaranteed hard drawn copper, 100 ft. (postage 1/-) .. 1/10½	<b>VALVE LEGS</b> , nut and washer .. . . . 1d.	3 .. . . . 500 to 900 .. . . . 4/3
<b>CONDENSER VANES</b> , fixed & moving, per doz. .. 3½d.	<b>VALVE LEGS</b> , nut and washer per doz. .. 10d.	4 .. . . . 800 to 1350 .. . . . 4/6
<b>REAL GOLD CAT'S WHISKERS</b> .. . . . each 2d.	<b>VALVE PINS</b> , nut and washer .. . . . 1d.	5 .. . . . 1600 to 3200 .. . . . 4/9
<b>REAL GOLD CAT'S WHISKERS</b> .. . . . per doz. 1/5	<b>PLUNGER SPRINGS</b> , complete .. . . . 9d.	6 .. . . . 2200 to 5600 .. . . . 5/-
<b>SILVER CAT'S WHISKERS</b> .. . . . each 1d.	<b>SLIDER ROD</b> , brass, 13 ins. long, ¼-in square, drilled .. . . . 3½d.	<b>EBONITE CONDENSER KNOB &amp; DIAL</b> .. . . . 1/6
<b>SILVER CAT'S WHISKERS</b> .. . . . per doz. 7d.	<b>SLIDER KNOB</b> .. . . . each 2d.	<b>FILAMENT RESISTANCE DIALS</b> .. . . . 8½d.
<b>CONDENSER SCALES</b> , 0 to 180 .. . . . each 3½d.	<b>SWITCHES ON EBONITE</b> , S.P.S.T. (quality the best) .. . . . 1/6	<b>VARIABLE CONDENSERS</b> of high quality. With Aluminium Top and Bottom plates. Complete with knob and dial, guaranteed accurate:
<b>IVORINE LABEL SET</b> , 12 different titles the set .. . . . 6½d.	<b>SWITCHES ON EBONITE</b> , S.P.D.T. (quality the best) .. . . . 1/11	Vernier .. . . . 4/- . . . . . 0005 .. . . . 6/-
<b>BASKET COILS</b> , set of 6, up to 3,000 metres .. 2/4	<b>SWITCHES ON EBONITE</b> , D.P.D.T. (quality the best) .. . . . 2/9	.002 .. . . . 4/6 . . . . . 00075 .. . . . 7/-
<b>SLEEVEING</b> , 3 yds. assorted colours .. . . . for 11½d.	<b>CONDENSER SPINDLES</b> , all sizes in stock, from .. . . . each 1½d.	.003 .. . . . 5/6 . . . . . 001 .. . . . 8/-
<b>NUTS, 2 B.A.</b> .. . . . per doz. 2½d.	<b>SCREWED ROD</b> , 2 B.A., 12 ins. long .. . . . each 2½d.	<b>SUPER QUALITY 2-WAY COIL HOLDER</b> .. . . . 5/3
<b>NUTS, 4, 5, 6 and 8 B.A.</b> .. . . . per doz. 2d.	<b>SCREWED ROD</b> , 4 B.A., 12 ins. long .. . . . each 2½d.	<b>REAL EBONITE 3-WAY COIL HOLDER</b> .. . . . 7/9
<b>WASHERS, 4 B.A.</b> .. . . . per doz. 1d.	<b>RUBBER-INSULATED LEADING-IN WIRE</b> per yd. .. . . . 1½d.	<b>O.B.A. NUTS</b> .. . . . per doz. 4d.
<b>WASHERS, 2 B.A.</b> .. . . . per doz. 1½d.	<b>VARIABLE GRID LEAK</b> , Pencil Type .. . . . 1/11	<b>DETECTOR ARMS</b> , Ball Joints, Ebonite Handle and Whisker Holder .. . . . 3½d.
<b>CONTACT STUDS</b> , with nuts and washers per doz. .. . . . 4d.	<b>INSULATORS</b> , white reel, 2 in. .. . . . each 1d.	<b>WOOD SCREW TERMINALS</b> .. . . . each 1½d.
<b>TERMINALS</b> , with nut and washers, each 1d., 1½d., & 2d. .. . . . each 2d. & 3d.	<b>INSULATORS</b> , white egg, each 2d. .. . . . per doz. 1/8	<b>SHELLAC</b> .. . . . per bot., 10½d. & 6d.
<b>EBONITE KNOBS, 2 B.A.</b> .. . . . each 2d. & 3d.	<b>WOUND INDUCTION COILS</b> (postage gd.):	<b>AERIAL PULLEYS</b> , each 10½d., 8½d., 6d., and 4½d.
<b>SPACING WASHERS</b> , large .. . . . per doz. 2½d.	12 x 4 .. . . . 2/5	<b>TINFOIL</b> .. . . . large sheet 4d.
<b>SPACING WASHERS</b> , small .. . . . per doz. 1½d.	8 x 4 .. . . . 2/3	<b>COPPER FOIL</b> , 6in. wide .. . . . per ft. 5d.
<b>CRYSTAL CUPS</b> , 2 screw .. . . . each 1d.	6 x 2½ .. . . . 1/11	<b>GRID LEAKS</b> , 2½ and 2 meg. .. . . . each 10½d.
<b>CRYSTAL CUPS</b> , 4 screw .. . . . each 2d.	6 x 3 .. . . . 6 x 2	<b>FLEX (Twin)</b> , various colours .. . . . per yd. 2d
<b>FIXED CONDENSERS</b> , all capacities each 10½d.	1/8 .. . . . 1/5	<b>CONNECTING WIRE</b> , tinned copper, 20 gauge 3 yds. .. . . . 2d.
<b>EBONITE</b> , cut to any size, by machinery while you wait .. . . . per lb. 3/6.	<b>TAPPED INDUCTION COILS</b> , 20 tapplings, wound to 1,000 metres .. . . . each 2/6	<b>ENAMEL WIRE</b> , in ¼, ½, and 1 lb. reels: 22 .. . . . 24 .. . . . 26 .. . . . 28
<b>TELEPHONE TERMINALS</b> , nuts and washer, each 1½d. .. . . . per doz. 1/3	<b>VARIOMETERS</b> (Tube type), complete with knob .. . . . 3/11 & 2/11	per lb. 2/4 .. . . . 2/8 .. . . . 3/2 .. . . . 3/6
<b>W.O. TERMINALS</b> , nuts and washers, each 1/7	<b>DOUBLE 'PHONE CORDS</b> , full length .. . . . 11½d.	Note: Bobbins 2d. each extra.
<b>W.O. TERMINALS</b> , nuts and washers, per doz. .. 1½d.	<b>HERTZITE</b> , genuine, in box .. . . . 8d.	<b>POTENTIOMETERS</b> , guaranteed up to 900 metres, superior make, compact size .. . . . 7/3
<b>PANEL BUSHES</b> , drilled .. . . . each 1½d.	<b>TALITE</b> , genuine, in box .. . . . 8d.	<b>CRYSTAL DETECTOR</b> , glass enclosed, fitted on 4 x 2 ebonite panel with terminals for aerial, earth and 'phones, already wired and beautifully finished .. . . . 4/9
<b>PANEL BUSHES</b> , drilled .. . . . per doz. 1/3	<b>PERMANITE</b> , genuine, in box .. . . . 8d.	<b>VALVE HOLDERS</b> .. . . . each 10½d. and 1/3
<b>TOP CONDENSER bushes</b> .. . . . each 1d.	<b>ZINCITE</b> , genuine, in box .. . . . 8d.	<b>AMALGO-PLASTIC METAL</b> , for fixing crystals. No Wood's metal necessary .. . . . 6d.
<b>TOP CONDENSER bushes</b> .. . . . per doz. 9d.	<b>BORNITE</b> , genuine, in box .. . . . 6d.	<b>GOLD SEAL PLASTIC METAL</b> , for fixing crystals .. . . . 6d.
<b>BOTTOM CONDENSER bushes</b> .. . . . each 1d.	<b>MIXED CRYSTALS</b> (6 kinds) .. . . . 9½d.	<b>IVORINE NAME-PLATES</b> , all readings, each 1d., per doz. .. . . . 9d.
<b>BOTTOM CONDENSER bushes</b> .. . . . per doz. 7d.	<b>CARBORUNDUM</b> .. . . . 5d.	<b>EARTH CLIPS</b> , Copper, adjustable .. . . . 5½d.
<b>SWITCH ARMS</b> , 4 laminations, ebonite knob, complete with panel, bush, nuts, and spring washer .. . . . 8½d.	<b>ZINCITE AND BORNITE</b> , both in box .. . . . 1/-	
<b>STOPS</b> , with nuts .. . . . per doz. 6d.	<b>BATTERIES</b> , H.T., dry:-	
	30 volts, including Wander Plugs .. . . . 5/9	
	60 volts, including Wander Plugs .. . . . 9/6	

**IMPORTANT: Mail Order Department: Orders Despatched Same Day as Received. NO WAITING.**  
**GOODS SENT TO ALL PARTS OF THE WORLD.**

**"DON'T PAY MORE" and get JUNK: "PAY LESS" and get the Goods AT**

## "ELKAY" WIRELESS CO.,

225 & 227, BISHOPSGATE, LONDON, E.C.2.

Open Saturday all day. To the Trade—New Trade Counter now open.

Please remit ample postage. We open Sundays, 11-2.30 Telephone Nos.—Central 8544, Retail. Bishopsgate 2313, Wholesale. Telegraphic Address: ELKAYWIRY AVE, LONDON.

**SPECIAL TERMS TO RADIO CLUBS.**

**SAVE MONEY BY STUDYING OUR ADVERTISEMENTS.**

For an announcement of vital interest to our customers see forthcoming Advertisements in "Wireless Weekly," "Popular Wireless," and "Amateur Wireless."



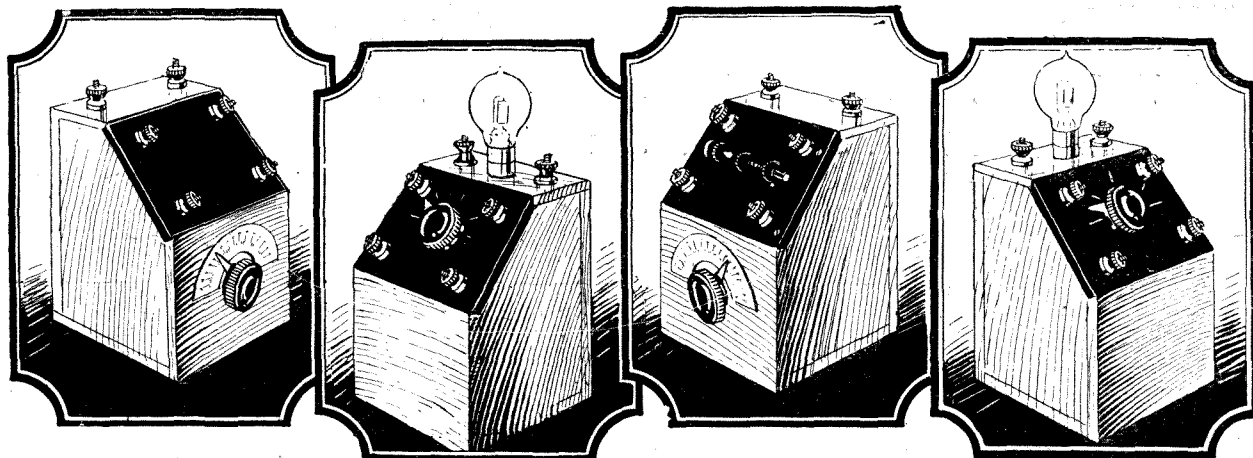

# Efficiency plus Economy

## The principles of the "Unit" System

The principle of this "Unit" Receiver is more or less along the lines of the well-known sectional Bookcase. From the first Unit—like the first section of the bookcase—it is ready for immediate service.

The first Unit to be constructed (No. 3 in the illustration) as a complete Crystal Receiving Unit. The design of this Unit is so efficient that Broadcasting has been received regularly at over 40 miles distance from the Station. The second Unit to be added is a Low Frequency Amplifier which greatly increases the volume of sound. If you live close to a Broadcasting Station these low Units should work a small loud Speaker. If you wish to increase its range, you can add the High Frequency Amplifier. These four Units give almost the range, sensitivity and volume of a three Valve Set with only the small upkeep costs of 2 valves. Full instructions are given for building absolutely every part in a particularly economical manner. Even if you already possess a Set you ought to get this Book—there are quite a number of new ideas sure to interest you.

THIS book, by Mr. E. Redpath, assistant editor of *Wireless Weekly*, should be purchased by every wireless enthusiast who is keen on simple constructional work for two reasons. First, because it describes a new idea in Wireless—a highly sensitive Receiving Set which, starting from a self-contained Crystal Set, can be added to, and made more efficient at any future time at small cost. Secondly, because not only are the elementary principles of Wireless soundly and simply explained, but every step in the actual constructional work is carefully shown by clear diagrams and well-written text. Even the beginner in Wireless can safely start on this Receiving Set and know that his efforts will be crowned with success.

## How to make a "Unit" Wireless Receiver

By E. Redpath.

### Contents

- Chapter 1.—The Essential Principles Involved.
- Chapter 2.—The Aerial—Earth System at the Receiving Station
- Chapter 3.—Unit No. 1. The Variometer Tuner with Crystal Detector.
- Chapter 4.—Unit No. 2. The Low-Frequency Amplifier with self-contained H.T. Battery.
- Chapter 5.—Units Nos. 3 and 4. Aerial Tuning Variometer and High-Frequency Valve Unit.
- Chapter 6.—The Completed Set and How it Works.
- Chapter 7.—The Construction and Erection of an Efficient Aerial.

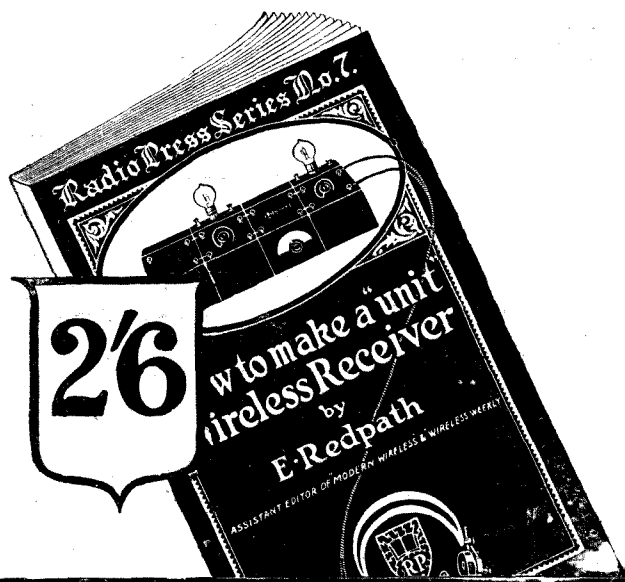

Sold by all Booksellers and Newsagents, or 2/8 post free direct from Publishers.

**Radio Press, Ltd.,**  
Publishers of Authoritative Wireless Literature  
DEVEREUX COURT, STRAND W.C.2

# CLIX

"The Electro-link with 159 Uses"

**WHAT IT IS:**

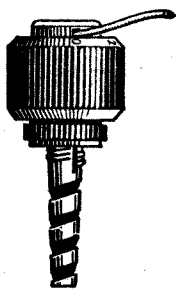

**CLIX** is a combined plug and socket.

**CLIX** is the simplest and most efficient contact or terminal in the world.

**CLIX** is instantaneously connected or disconnected.

**CLIX** is the solution of all difficulties in electrical connections.

**WHAT IT DOES:**

In wireless work a few of its uses are:—Terminals: Battery plugs, battery sockets, coil plugs, coil sockets, valve plugs, valve sockets, contact studs, soldering tags, multi-phone tags or plugs, connecting-lead tags or plugs, etc. Multi-contact, dead-end or any type of switch may be built up without difficulty.

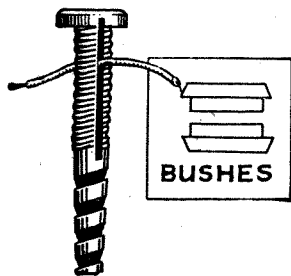

**BUSHES**

Because of its **Universal Application** and **Efficiency** you cannot afford to be without **CLIX**, which also has the supreme merit of being most inexpensive.

**RETAIL PRICES:**

- CLIX** ... .. 3d. each.
- " Locknuts ... ½d. "
- " Insulators ... 1d. "
- (Six Colours).
- CLIX Complete** ... 4d. each.
- " Bushes ... 1½d. pair.
- (For Wood Panels.)

Postage of any of the above, 3d. per doz. extra.

Obtainable from all Dealers or direct from the Manufacturers. Trade Inquiries Invited.

**AUTOVEYORS Ltd**  
84 VICTORIA ST., WESTMINSTER, S.W.1

Manufacturers and Patentees of the

**3-E.V.C.**

the Original and Only Complete Absorber of Disturbances

**BEGINNER'S GUIDE TO WIRELESS**

Best Book Obtainable.

If you wish to make your own receiver, or to improve the set you already have, you cannot do better than obtain this book.

**HOW TO ERECT, CONNECT, AND MAKE**

Aerials, complete crystal and valve receivers, coils, tuners, etc., also the latest two and three-valve tuned anode receivers and one and two-valve amplifiers. 144 pages (including 25 diagrams), 1/3 post free.

**SAXON RADIO CO. (Dept. 32), South Shore, Blackpool**

**THE EXHIBITION IS CLOSED**

**BUT OUR STAND IS PERMANENT. FOREMOST FOR BEST COMPONENTS AT LOWEST PRICES. DELIVERY BY RETURN—IF UNSATISFACTORY MONEY RETURNED IN FULL.**

- Aluminium Vanes, 5d. doz. Aerial Pulleys, 6d. Anti-Capacity Handles, 6d.
- Cats Whiskers—Gold, 2d.; Silver, 1d.; Spearpoint, 1d. Packet of 4, 6d.
- Coils, Basket, Set of 6, 2/-. Waxless, 2/4. 4½vt. Batteries (British) 6d. each.
- Coil Holders, solid ebonite, 2-way, 3/6; 3-way, 4/6. Sockets, 7½d. each.
- Condenser and Grid-leaks, 2/6. Grid-leaks, all megs., 1/- and 1/6.
- Condensers, Fixed.—To .001, 9d.; To .005, 1/6; To .01, 2/6; To .1, 3/6;
- Ditto., Variable—.001, 8/6; .0005, 6/6; .0003, 5/6; .0002, 4/6;
- .0001, 4/6. With ebonite or aluminium end plates, .088 spacers.
- Condenser Dials, 0.180, 11d.; with knob, 1/4 and 1/9. Bushes—Top, 1d.; Bottom, 1d.
- Ditto End Plates, 1/6 pair, drilled. Solid ebonite.
- Contact Studs, 4d. doz. Stops, 2 a 1d. Connecting Wire, tinned copper, 3 yds. 2d.
- Crystals. Every make stocked. Zincite, 9d.; Bornite, 6d.; Talite, 1/6; Hertzite, 1/6; Galena, Silicon, Carbon—0.1, 3d.; Copper Pyrites, 6d.
- Gold Seal Lastic Mats for fixing Crystals, 6d. box.
- Crystal Cups, 4-screw, 1½d. Detector Glasses, 4½d. each. Buzzers, 2/6.
- Crystal Detectors. Plain brass, 1/3; Nickel, 1/6; Dustproof, 1/9, 2/6; Plug-in Type, 3/6; Perikon, 2/6, 3/6 (with Zincite and Bornite).
- Crystal Detector Parts, in envelope, 10½d. Nickel, 1/6.
- Earth Clips, adjustable, 6d. Ebonite, 3/6 lb., any size. Fil. Resist. Dial, 9d.
- Filament Resistances, 1/6, 2/6, 3/6, with dial, 2/6; porcelain base, 4/6.
- Foil. Copper, 3d. foot. Tin, 4d. Formers, 12 by 2, 3d.; 12 by 4, 4d.; 12 by 5, 5d.
- Headphones, Continental, 11/6 and 16/6. British, 14/6 to 25/6. N. & K., 12/9.
- Insulated Hooks, 1½d. Tape, 6d. roll. Insulators—Egg, 1½d.; Reel, 1d.; Shell, 2d. Frame Aerials, detachable, 19/6.
- Jack and Plug, 1/6. Lightning Arresters, 2/6 each. Spade Terminals, 1d. each.
- Knobs, finest, 4d. and 2d. Lead-in Tubes, 12 in., 11d.; 9 in., 10d.; 6 in., 9d.
- Loud-Speaker Aluminium Trumpets, 6/9 each. Screwed Rod, 12 in. 2 B.A., 3d.; 4 B.A., 2½d.
- Mica, .002, 2d. sheet. Nuts, 2 B.A., 2½d.; 4/5/6/8 B.A., 2d. doz.; O.B.A., 4d. doz.
- Scales, Ivorine, 0.180, 3d. Set Name Tabs, 6d. Bell Wire, 12 yds. 6d.
- Slider Rods, 3½d. Plunger, 2d. Best Ebonite, 6d. Wound Vario-couplers, 6/6.
- Spacers, large, 2½d. doz.; small, 1½d. doz.
- Sleeving, all colours, 3 yds., 2 mm., 11d. Shellac, 8d. bottle.
- Switches, lacquered brass on ebonite, S.P.S.T., 1/6; S.P.D.T., 1/6; D.P.D.T., 2/6.
- Switch Arms, 1st quality, 8d. Screws, all B.A.'s—To ½ in., 5d.; To 1 in., 9d. doz.
- Transformers, H.F. Plug, 1, 250/600, 3/8; 2, 350/700, 4/6; 3, 500/900, 4/3; 4, 800/1,350, 5/6; 5, 1,600/3,200, 4/9; 6, 2,200/5,600, 5/6.
- Transformers, approx. 5 to 1, L.F., 10, 6, 11/9 and 15/6; all guaranteed.
- " Powquip," 13/6; best nickel, 14/6. Bobbins, 1/6. H.F. Formers, 2/6.
- Terminals, W.O., 2d.; telephone, 1½d.; pillar, 2d.; wood screw, 1½d.
- Telephone Cords, 10½d. Tablets (Earth, Aerial, etc.), 1d. each. Flex (twin) 2d. yd.
- Variometers, double wound, 2/11; Ebonite mounted, 6/6. Formers, 6d. pair. Wound Coils, 12 by 4, 2/5; 6 by 3, 1/8; 9 by 3, 2/3.
- Valve Holders, finest ebonite, 1/3; moulded, 9d. (all with nut and washer).
- Valve Legs, 10d. doz. Valve Pins, 9d. doz. Voltmeters, 5/6 and 8/6.
- Wander Plugs, 3d. each. Washers, all B.A.'s, 1d. doz. Wood's Metal, 3d.

**Largest Stocks in British Isles.**

Impetative.—Kindly send ample postage; balance always refunded. SEND FOR FREE LIST. Trade supplied at separate trade counter.

**RADIO STOCKS, Ltd.**

Museum 4213. (Mail Order, "Radio House.")

87/89, NEWMAN ST., OXFORD ST., LONDON, W.1.  
Between Oxford Circus and Tottenham Court Road.  
And at 44a, Cranbourn St., Leicester Square, W.C.2.

**ELECTRADIX RADIOMETERS.**

- Wavemeters from 100 to 10,000 metres. From £2 10 0. New Ex. W.D.
- Miliameters for Fine Tuning 17/6 to 35/6.
- Voltmeters, Panel and Portable, a volts to 2,500 volts, 5/- to £5.
- Recorders. Wireless Morse Inkers make long wave reception interesting. £6 10 0.
- Motor Alternators. Wonderful £50 machines for £3. Ex Aircraft.
- Potentiometers. Army 350 ohm 3/6. For details see "Wireless World" or our 3d. Catalogue.

We have many thousand pounds' worth of the pick of Government Wireless gear displayed at our London Showrooms at 9, Colonial Avenue, Minories (near Aldgate Station).  
**LESLIE DIXON & CO.** Ave. 4166

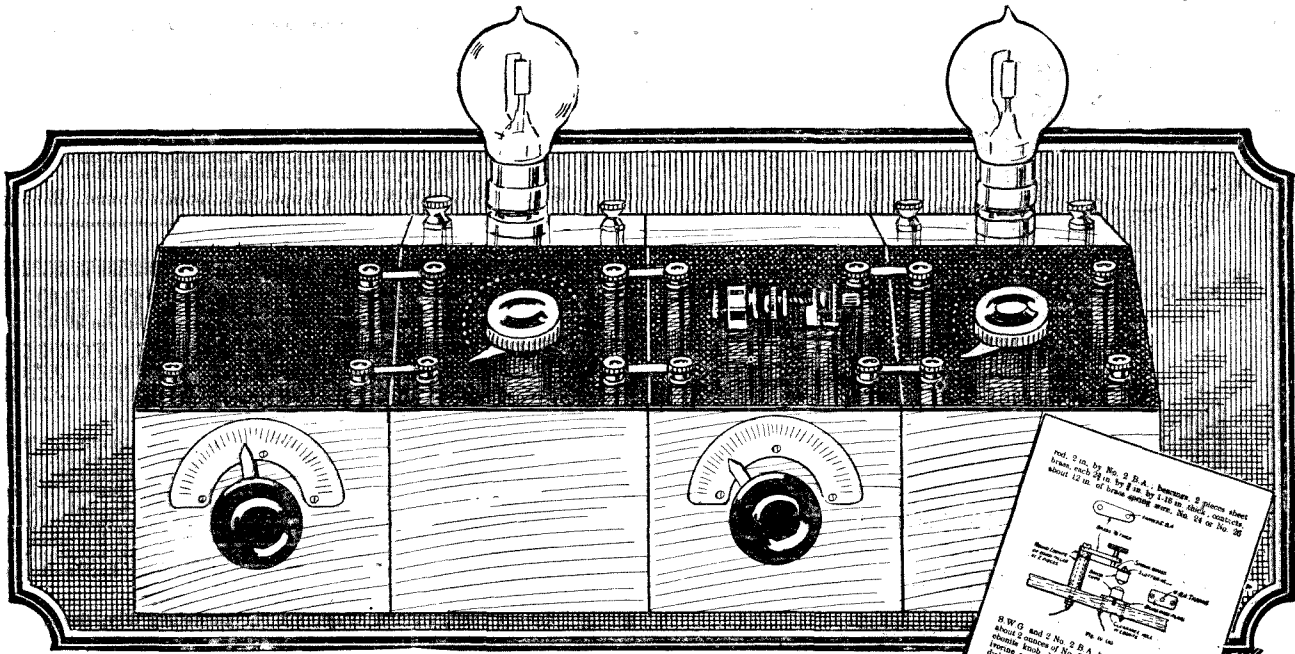

## Such clear instructions enable anyone to build this excellent 4-Unit Set

ONE special feature of this new Book is that it does not presume any knowledge of Wireless at all on the part of the purchaser.

Constructional articles in "WIRELESS WEEKLY" and "MODERN WIRELESS" necessarily anticipate that the reader has some knowledge of Wireless—if only of the most elementary kind.

Even if you don't know one end of the Receiving Set from the other, and have never even "listened in," you can buy this Book confident that you can build your own Set—one which will give you particularly good results over long distances.

The Receiving Set described in this Book is quite different to any yet placed on the market. It is particularly neat and efficient, and as an economical Set it is certainly without parallel. For, at an original outlay of a few shillings, it is possible to construct the Detector Unit (which uses a crystal) and to enjoy the pleasures of "listening in" right from the very beginning. Later on—and at your convenience—you can add valves which will enable you to pick up Broadcasting stations further away, or to use a Loud Speaker instead of head-phones.

The whole Instrument has been carefully designed and tested for reception over long distances.

Get a copy Now—and start Wireless economically.

Radio Press Ltd., Devereux Court, Strand, W.C.2

# How to make a "Unit" Wireless Receiver

by E. REDPATH (Assistant Editor of "Wireless Weekly.")

RADIO PRESS  
Wireless Library  
No. 7.

2/6

or 2'8 postfree

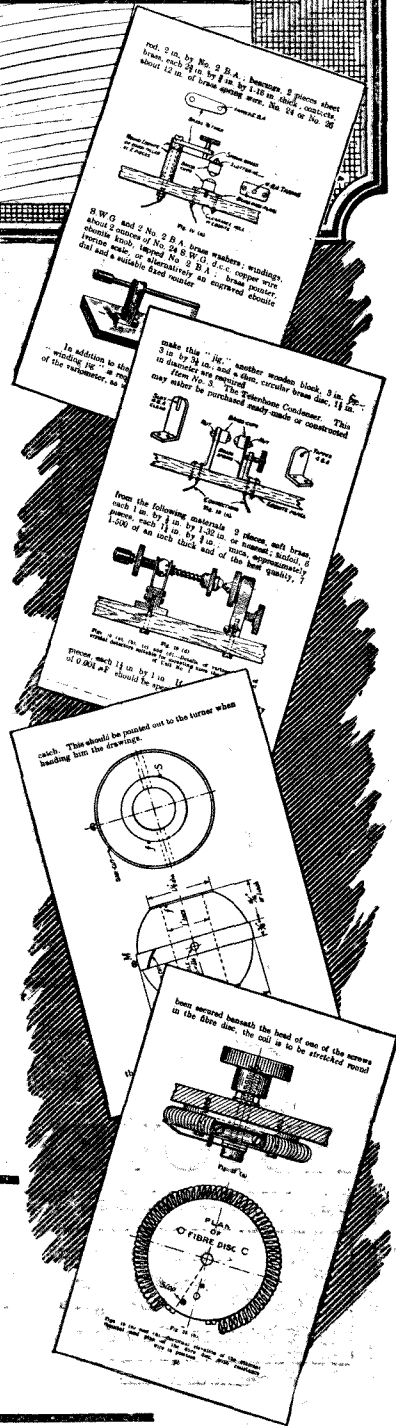

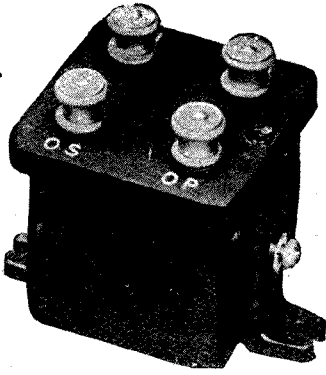

Intervalve Transformer Type "A"

Our manufactures include:  
"Ironclad" Transformers  
Intervalve.

- Type "A" .. £1 2 0
- "B" .. £1 6 0
- "C" .. £1 6 6

Telephone.

- Type "A" .. £1 0 0
- "B" .. £1 5 6
- "C" .. £1 6 6

Tone Selectors.  
Price : £1 5 0

Plug and Socket Terminals.  
Price : 1/- per pair

Filament Resistances.  
Price : From 4/3.

Lead-in Insulators.  
Price : From 2/3.

Valve Holders. Price : 2/-  
Potentiometers. Price : 7/-  
Fixed Condensers, 8 capacities. Price : From 3/9

Coil Holders.  
1 coil 5/6  
2 " 14/-  
3 " 17/-

The famous "Block" Batteries, 8 Types.

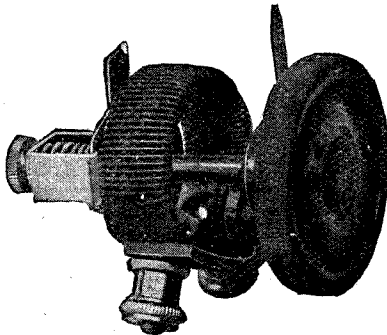

Filament Resistance

Write for Catalogue No. 315, fully describing the "Fuller" range.

## What Experimenters say about Fuller Parts



Here is proof of the undoubted efficiency and reliability of "Fuller" Components. The results obtained by other experimenters are your protection and, in addition, every "Fuller" Wireless product carries with it a twelve months' guarantee.

October 7th, 1923.

NEW YORK ON A LOUD-SPEAKER.  
"You may be interested to know that I got WGY New York on a loud speaker on September 1st and WDAP Chicago on September 7th, using 1 H.F. Detector and 2 L.F. Valves.

"The Low-Frequency Transformers were your "FULLER INTERVALVE TRANSFORMERS," and personally I think that you manufacture the best transformer on the market.

"They give maximum amplification with no distortion and are absolutely free from noises common to most L.F. transformers."

July 18th, 1923.

"I am writing about your totally enclosed intervalve and 'phones transformers.

"They are exceptionally good, and the enclosure box is a great improvement: it does not upset component parts near by, by the seemingly large mass of iron, and although provided with earthing terminals is not essential."

February 26th, 1923.

"We are using nothing but your transformers in all our apparatus, and find them wonderfully satisfactory. We might add that our amplifiers have met with great success and compare very favourably with all the leading makes with regard to efficiency, and we cannot fail to see that at least the greater proportion of this is due to your transformers."

We invite you to visit our London Depot, 53, High Street, W.C.2, close to Tottenham Court Road Station, where you can inspect these components for yourself.

**Fuller's United Electric Works, Ltd.,**  
Woodland Works, Chadwell Heath, Essex.

Telephone :  
Ilford 1200 (6 lines).

Telegrams :  
"Fuller, Chadwell Heath."

# EVER-READY

BRITISH MADE

## DRY BATTERIES & ACCUMULATORS

FOR EACH AND EVERY WIRELESS PURPOSE

INSIST ON  
"EVER-READY"  
WIRELESS  
BATTERIES AND  
OBTAIN SATISFAC-  
TION AND 100 PER  
CENT. EFFICIENCY

OVER 20 years' experience and research, the finest materials, expert supervision, and careful testing at all stages of manufacture are the reasons for the superiority of "Ever-Ready" Wireless Batteries.

The "Ever-Ready" series embrace all types of Batteries for every Wireless purpose.

Special types of large capacity Dry Batteries are provided for the filament heating of each of the newest types of low-temperature valves.

Write for particulars of these and the standard sizes and voltages of high-tension Battery units.

Service D.X. Department,

The **EVER-READY**  
Coy. (Great Britain) Ltd.  
Herecu's Pl., Holloway,  
LONDON, N.7.



## WELCOME NEWS

—For the Experimenter

TOTALLY NEW EQUIPMENT FOR SET-BUILDERS

FOR some time past much of our time has been concentrated on the production of a complete series of component parts with the help of which the assembly of the latest receivers, embodying the ideas set forth in "Wireless Weekly" and "Modern Wireless," can be made with the minimum of time, and with the certainty of first-class results.

The designs of these components are entirely new, and constitute further examples of the efficiency and robustness of Bowyer-Lowe productions.

Equipped with a selection of these components, the experimenter will be able to assemble a receiver of pleasing appearance in an extremely short time, while the expense incurred in changing from one circuit to another is trifling.

An illustrated descriptive pamphlet is now ready and a copy will be sent on application. Send a postcard now.

Supplies of the components can be obtained from any wireless dealer, or, in case of difficulty, we shall be pleased to supply direct.

The **BOWYER-LOWE** Co., Ltd.  
Letchworth, Herts.



Wholesale Distributors for the North of England:  
**MILLIGAN WIRELESS, Ltd., 23-25, Renfrew St. GLASGOW;**  
**H. WADSWORTH SELLERS & Co., Standard Buildings, Leeds;**

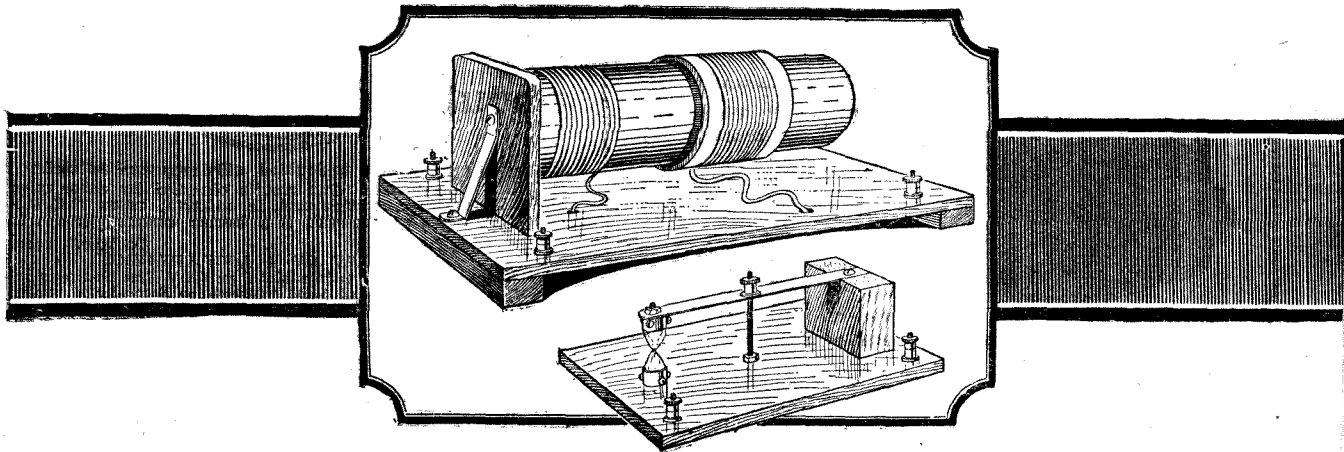

# A Crystal Set is always useful—

**No. 3**  
of the  
**RADIO PRESS**  
Series

WHEN your Accumulator runs down, or your Valve burns out, or your H.T. Battery suddenly develops noises—these are the occasions when you would give almost anything for some means of “carrying on.” Why not forestall these possibilities by making a Crystal Set now?

This new Book by John Scott-Taggart, Editor of “Wireless Weekly” describes three useful Sets which can be made by anyone without special skill in the use of tools. In fact, the simplest of them (illustrated above) can even be constructed of material you would find around the house.

All have been designed to give good results with a range of, say, 25 miles from your nearest Broadcasting Station.

Get a copy of this Book to-day—even if your present Set seems immune from breakdown, you will never regret the time spent on building a Crystal Receiver.

## Contents

- Some General Principles.
- The Question of Licences.
- Parts of the Wireless Receiver.
- Crystal Detectors.
- Inductance Coils.
- The Construction of the Crystal Detector.
- Connecting up the Receiver.
- Operation of the Set.
- The Variable Inductances.
- The Telephone Condenser.
- Operation of the Circuit.
- Erecting your Aerial.
- Insulating your Aerial.
- General Dimensions of the Aerial.
- Constructional Details when using Masts.
- The Down-lead and Lead-in.
- Adjusting the Span of the Aerial.
- Twin-wire Aerials.
- The Earth Connection.
- The Aerial-earth Switch.
- Some remarks on Tuning.
- Receiving Paris Signals.

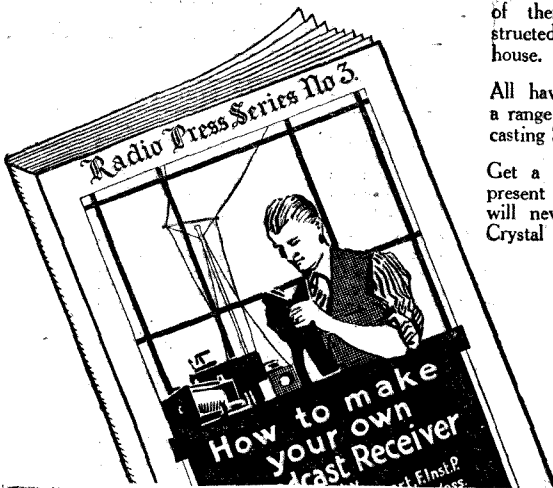

**Radio Press, Ltd**  
PUBLISHERS OF AUTHORITY WIRELESS LITERATURE  
BEVEREUX COURT, STRAND, W.C.2.

From all Booksellers  
and Newsagents, or  
1/7½ post free direct

# How to make your own Broadcast Receiver

By John Scott-Taggart, F.Inst.P.

# 1/6

UTILITY ENDORSED  
BY THE EDITOR OF  
"WIRELESS WEEKLY"

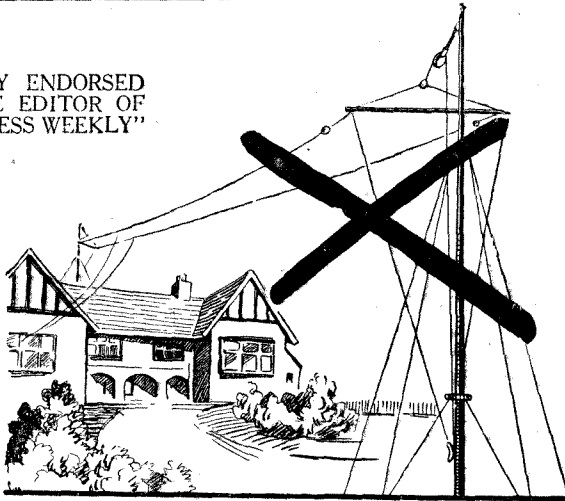

THE  
**CHEAPEST AERIAL**  
AND THE BEST  
**IN THE WORLD.**

100 Feet. **1/8** CARRIAGE PAID.

**WIRELESS MASTS**  
ABSOLUTELY  
**UNNECESSARY**

The simplicity in erection is beyond the dreams of all wireless enthusiasts, as the troublesome insulators are absolutely unnecessary. Suspend this wire where you will, lead in, and your result is there. It is a simple matter to make a portable aerial from this wire or to run a lead-in from the house to the garden, whether it is a few yards or half a mile. Ideal for telephone work all over the world.

Darnall, Sheffield.

DEAR SIR,  
No doubt you remember me purchasing 100 ft. of your rubber-covered telephone cable three weeks back.

I must say that the said wire gives splendid results as an aerial, and friends who have listened in are so surprised at the results, and the ease with which the wire is put up, that two of them have asked me to purchase them a 100-ft. length from you. So would you kindly forward me 200 ft. of the same wire. I enclose P.O. for 3/4 for same.

Thanking you in anticipation,

I remain, Yours faithfully,

T. ELLIOTT.

P.S.—Would you kindly enclose the wire in two 100-ft. lengths, and oblige.

Supplied in 3 Thicknesses on original drums. Special terms to the Trade.

- Class 0** 1/4 mile (Thin for light work) 15/- Per drum,
- Class 1** 1/2 mile (Medium for most jobs) 35/- Carriage forward.
- Class 2** 2 mile (Thickest for heavier work) 70/- forward.

Orders for 6 miles assorted (if required), carriage paid.  
Smaller Quantities of Class 1 (Medium) sent carriage paid.

300 feet **4/3** 500 feet **6/3** 1,000 feet **10/3**  
Carriage Paid.

IDEAL FOR ALL TRAINING PURPOSES IN THE GARDEN, FOR FRUIT TREES, PEAS, BEANS, etc.

**NEW LONDON ELECTRON WORKS, LTD.,**  
99, Regent's Dock, London, E.14.

TELEPHONE: EAST 1821. TELEGRAMS: "STANNUM, STEP, LONDON."

Manufacture of Broadcasting Apparatus.

Use of Patents.

THE pioneer work of the Marconi Company in connection with wireless telegraphy and telephony is well known, and as the result of many years of research work and considerable expenditure, the Company controls numerous patents relating to the manufacture or use of wireless telegraph and telephone apparatus.

The Company is prepared to grant a licence for the use of its patents in connection with the manufacture of broadcasting apparatus to any member of the British Broadcasting Company, Limited.

A large number of firms (including the principal manufacturers) are already so licensed and pay royalty for the use of these patents, and all apparatus manufactured under licence is so marked.

Any persons or firms manufacturing or offering for sale valve apparatus embodying patents controlled by Marconi's Wireless Telegraph Company, Ltd., without its permission render themselves liable to legal proceedings for infringement.

Whilst hoping that it will not be forced to take legal proceedings the Marconi Company wishes to give notice of its intention to protect its own interests and those of its licensees, and in cases of infringement the Company will be reluctantly compelled to take such steps as may be necessary to defend its patent rights.

**Marconi's Wireless Telegraphic Co., Ltd.,**  
Marconi House, Strand, London, W.C.2.

VARIOMETERS.—British Made.

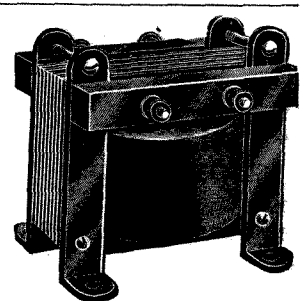
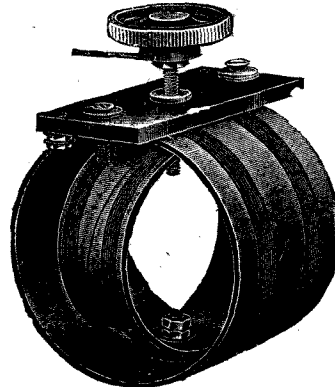

LOW FREQUENCY TRANSFORMERS, BRITISH-MADE.

Unsurpassed for Silence, Efficiency and Reliability. Transformer gives better results. No. 80r.—With Loose Wires, 17/- No. 80c.—Terminal Type, as illustrated, 18/- Post Free.

Large illustrated Catalogue of: Wireless Sets and Component: Parts, post free on request.

BRITISH-MADE "SONYTE" PHONES.

The features of these excellent Receivers are Extreme Lightness, Comfort and Self-Adjustment, Maximum Possible Efficiency and Audition.

Ladies particularly like this Receiver owing to its comfort and ease in adjustment.

Compares favourably in appearance and efficiency with others sold at much higher prices.

17/6 Post free.



The UNIVERSAL ELECTRIC SUPPLY CO.,  
4, BROWN STREET,  
MANCHESTER.

Box No. G.P.O. 519. Est. 1892.



Published November 8th.

500  
Wireless Questions  
Answered

By E. REDPATH and G. P. KENDALL, B.Sc.

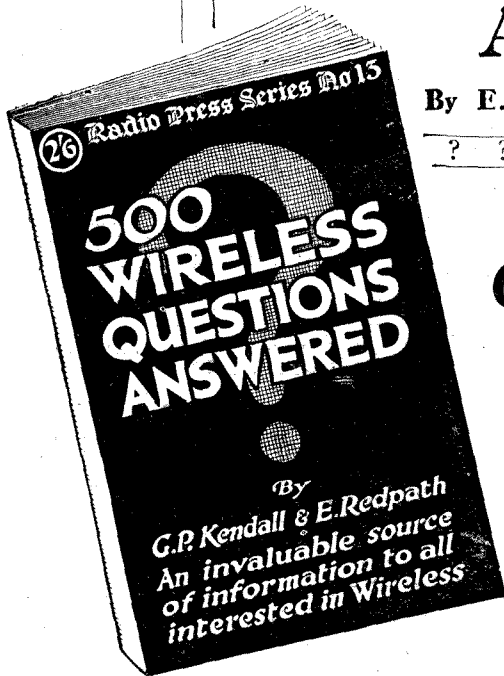

Get the right information  
—quickly!

THIS Book is going to be one of the most useful and popular Radio Books ever published. No matter how much or how little you know, there will often arise little difficulties and queries which need explanation.

Instead of having to wade through pages of text-book matter to obtain the information you need, all that you have to do is to refer to **500 Wireless Questions Answered** and in a moment you have the information accurately and concisely.

If you are in difficulties with the Set you are building—if the Set you are using is not working to your complete satisfaction, it is probably due to your lack of knowledge of some fundamental Wireless principle. Get the facts from this real "Wireless Encyclopædia"; it will save its cost to you time and again.

Questions about :

- Aerials.
- Frame Aerials.
- Earths.
- Waves.
- Wave-Lengths.
- Tuning Coils.
- Tuning Condensers.
- Valves.
- Reaction.
- Primary Batteries.
- Secondary Batteries.
- Crystal Sets.
- Amplifiers.
- Grid Leaks and Condensers
- Loud-speakers.
- Wire.
- Range (transmitting and receiving).
- Interference.
- Morse Signals.
- Sounds and Signals heard.
- Telephone Receivers.

Published by

RADIO PRESS LTD.,  
Devereux Court, STRAND,  
W.C.2.

From all Booksellers  
and Newsagents or  
2/8 post free.

2/6

Radio Press Series No. 13.

# EXPERIMENTERS and EXPERIENCE

THE MARCONI SCIENTIFIC INSTRUMENT CO. are rightly considered pioneers. They have studied the needs of the Experimenter from the standpoint of Science and Experience. M.S.I. Components are proved efficient. The success of your experiments, the successful operation of your set—is built upon the choice of components. Choose those which have made the name of MARCONI SCIENTIFIC INSTRUMENT CO., LTD., what it is to-day.

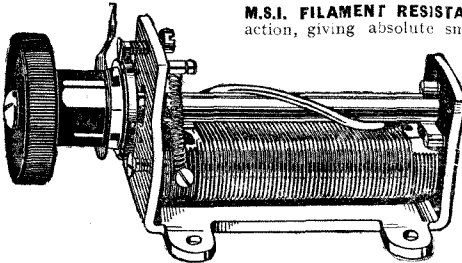

**M.S.I. FILAMENT RESISTANCE**, with patent worm action, giving absolute smooth and silent motion, capable of most delicate adjustment.

This Resistance takes complete control of filament temperature. And in such circuits where filament control is critical, the M.S.I. Filament Resistance is vitally necessary.

Supplied complete with Scale, Knob, Pointer and Template for mounting. Price 9/6.

**THE NEW MARCONI SCIENTIFIC DOUBLE VARIABLE CONDENSER** enables two stages of high-frequency amplification to be handled as easily as one.

It consists of two perfectly matched variable condensers on a single shaft, the two sets of fixed plates being carefully insulated from one another, and the moving plates connected electrically. The same knob operates both condensers, and if the coils are matched perfect simultaneous tuning is possible. The plates are made from sheet brass, soldered into brass supports, the usual washers being dispensed with. The end plates are also of heavy brass.

Capacity each half ... .. .00025 mfd.  
For Panel Mounting ... .. £1 10 0

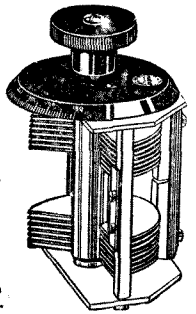

**M.S.I. VARIABLE CONDENSERS.** The material used in the construction is identical with that employed in the Double Anode. Supplied with turned Ebonite Knobs, rotating dials and necessary brass washers and fixing screws. If preferred they may be fitted with Ivorine Scales and Pointers.

.001 mfd. ....	£1 5 0
.0005 mfd. ....	£1 2 6
.00025 mfd. ....	£1 0 0
.0001 mfd. Vernier type	£0 17 6

Thoroughly tested before being despatched.

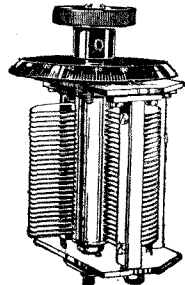

**M.S.I. INTERVALVE TRANSFORMERS** are known to stand up to conditions which have broken down other transformers. They are constructed on purely scientific lines, the soft iron wire core being brought out round the outside of the coils, thus forming an efficient shield to extraneous magnetic fields.

The coils are wound with the finest grade double silk-covered wire, ensuring the minimum amount of low-frequency distortion.

Ratio 1-3.

Price 30/- Mounted and Screened.

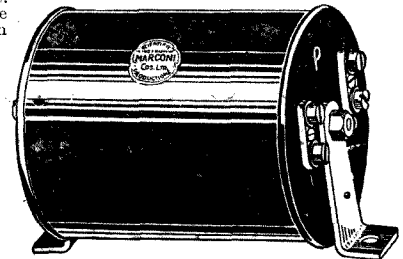

## MARCONI SCIENTIFIC INSTRUMENT CO., LIMITED,

70, DUDDEN HILL LANE, LONDON, N.W. 10.  
TELEPHONE: WILLESDEN 2617-8. TELEGRAMS: WILLROAD, LONDON.

London Depot: 21-25, St. Anne's Court, Dean St., W. 1.  
London Showrooms: 40, Dean St., Oxford St., W. 1.  
TELEPHONE: GERRARD 7745-6. EXT. 4.

## PIVAL SINGLE RECEIVERS

These were first introduced by us over twelve months ago and have STOOD the TEST of TIME. Moulded ebonite receivers, giving perfect reception, complete with hook and cord (as illustrated).

No. 203 6/6 No. 203A 7/6  
2000 ohms 4,000 ohms

Postage and Packing 4d. extra.

If your LOCAL DEALER cannot supply, send direct to us.

DELIVERY FROM STOCK.

Satisfaction Guaranteed or Cash Refunded.

We are Sole Agents for the ECCENTRO DETECTOR.

Price 8/- post free.

Revised List sent post free.

TRADE SUPPLIED AT RIGHT PRICES

**W. JOANES FOR PHONES,**

42, Jenner Road, Stoke Newington, London, N.16.  
Telephone: "Dalston 4741." Telegrams: "Creneva, Stoke, London."

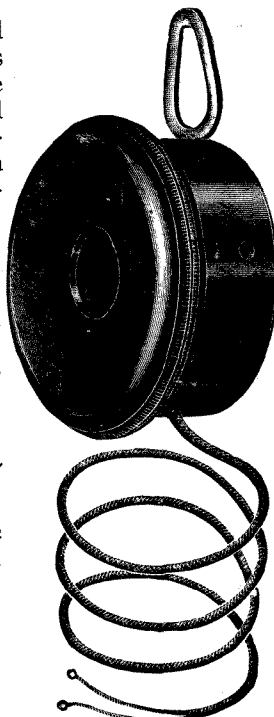

To obtain the best results from your S.T.100 ALL-CONCERT Transatlantic, and Reinartz Receivers, Magnum Components are essential. Components suitable for the TRANSATLANTIC NOTE MAGNIFIER as described in this issue.

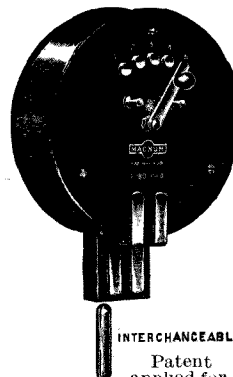

	Each.
	s. d.
Magnum "Magnifier" Transformers ... ..	15 0
Rotary Filament Resistances ... ..	4 6
Rotary Switch on Ebonite Disc (2 stud) ... ..	2 9
Valve Holders ... ..	10
Terminals (Lacquered) ... ..	2
Inspection Windows ... ..	9
Jacks (Best Quality) ... ..	7 6
Plugs (Best Quality) ... ..	5 0
H.T. Condenser (Ex Govt.) ... ..	2 6
Ebonite (Best Quality A.H.R. Co.) cut to size, per lb. ... ..	4 0
Valves ... ..	15 0
Twin Flex, per yard ... ..	4

Carriage Paid on all orders for £2 or over. Cash with order.

INTERCHANGEABLE BUY BRITISH COMPONENTS.

Patent applied for A milestone in the progress of Wireless—the Famous Magnum Tapped Coil, specially recommended for ST100, All-Concert, Transatlantic and all circuits where Plug-in Coils are used.

	s. d.
No. 1—180-1,000 metres, replaces 4 ordinary coils. ... ..	15 6
No. 2—600-2,600 metres " 3 " " " ... ..	17 6

Post Free. Cash with order.

The Ideal Christmas Gift, bringing Joy and Romance, is the Magnum Crystal Set. Solid Ebonite P.O. Instrument finish, wound D.S.C. A scientific instrument in design and finish. Weight, 6 oz. Size, 4 in. high by 2½ in. on 3¼ in. base.

PRICE, 22s. 6d., post free.

Descriptive leaflet on request.

**BURNE-JONES & Co., Ltd.,** Manufacturing Radio Engineers,  
MONTFORD PLACE, KENNINGTON ROAD, LONDON, S.E. 11  
Phone: Hop 6257.

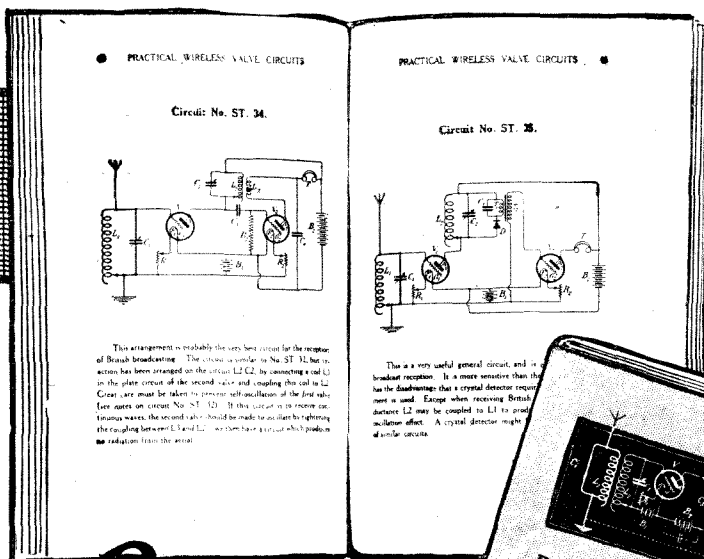
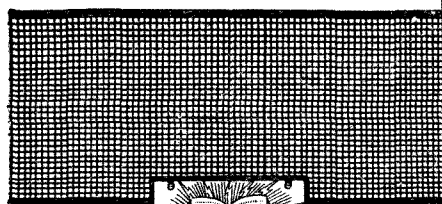

# No Paper Circuits

Every one  
the result of practical tests



## Circuits ST.1 TO ST.67

WHEN building your Set you will want to be confident that the circuit is the best possible. Many circuits often recommended are only "theoretical" circuits, and when the user comes up against the hard school of actual practice he is apt to get disappointing results.

If you get a Book like *Practical Wireless Valve Circuits*, you are guarded against this. Every circuit—and there are over 60 of them—has been actually tested under working conditions, and where necessary typical valves for fixed condensers and resistances are given.

Many circuits are quite new, and all are the result of many years' Radio research work by John Scott-Taggart, F.Inst.P. (Editor-in-chief of *Modern Wireless* and *Wireless Weekly*).

Buy a copy to-day—keep it for reference, you will find it a continual help.

**RADIO PRESS, LTD.,**  
**Devereux Court, Strand, W.C.2**

## Practical Wireless Valve Circuits

### CONTENTS.

1. Crystal Detector Circuits.
2. Single-Valve Circuits.
3. Two-Valve Circuits.
4. Three-Valve Circuits.
5. Four-Valve Circuits.
6. Five-Valve Circuits.
7. Local Oscillators for Heterodyne Reception of C.W.
8. Valve Transmitter and Radiophone Circuits

# 2/6

From all Booksellers or 2/8 post free from the Publishers.

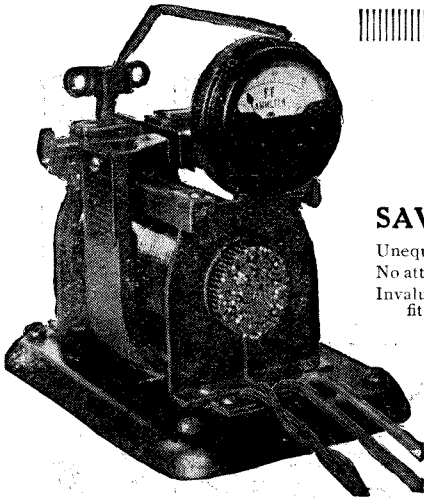

A.C. Model  
Output 5/10 amps. 9 volts. Complete with Pole Indicating Ammeter and all connecting leads and adapter.  
£6 0

# “ELLA”

## BATTERY CHARGERS

*They work from a Lampholder.*

### SAVE THEIR COST IN A FEW WEEKS.

Unequaled for design, workmanship and efficiency in operation. No attention required—will work during the night. Invaluable for charging car batteries where lighting dynamo is not fitted.

### HUNDREDS ALREADY IN SERVICE.

ELLA Wireless Volt Meters, portable and switchboard patterns for reading plate and battery volts on one scale.

Pocket type, £1. Switchboard type, £1 5s., post free.

All makes British Headphones. All patterns British Valves from Stock.

*Trade also supplied.*

LIONEL ROBINSON & CO., 3g, Staple Inn, London, W.C.2.  
Phone: HOLBORN 6323

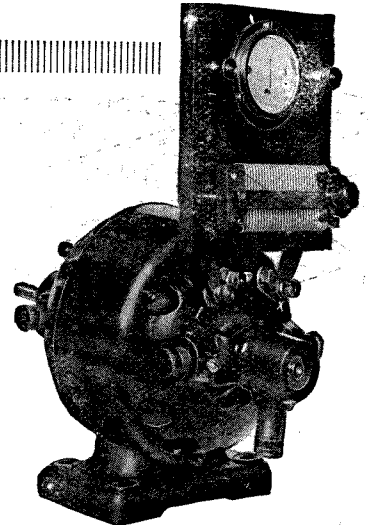

D.C. Model  
Output 5 amps. 9 volts. Machine only, £5 12 6. With Switchboard and Pole Indicating Ammeter and Regulating Resistance as illustrated, £6 15 0.

# ADVERTISEMENT RATES

## “ WIRELESS WEEKLY.”

### ORDINARY POSITIONS.

13 insertions consecutive	-	£15 per page and pro rata.
6 " " "	-	£15 plus 5% per page and pro rata.
1 to 5 " "	-	£15 plus 10% per page and pro rata.

### NEXT MATTER (In columns only)

13 insertions consecutive	-	£20 per page and pro rata
6 " " "	-	£20 plus 5% per page and pro rata.
1 to 5 " "	-	£20 plus 10% per page and pro rata.

# SCHEFF PUBLICITY ORGANISATION, LTD.

(Advertisement Managers, *Wireless Weekly* and *Modern Wireless*),

125, PALL MALL, LONDON, S.W.1.

'Phone—Regent 2440 (2 lines).

# —GRIFFIN'S—

80, NEWINGTON CAUSEWAY  
(Corner of Lancaster St.),

Hop 1806.

**Elephant & Castle, London, S.E.1.**

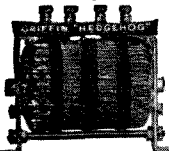

**THE 'GRIFFIN' UGLY  
HEDGEHOG L.F.  
TRANSFORMER**

PRICE  
**22/6**

Actual Ratio 4.7 to 1. each.  
Wound with 21,000 turns  
Best Silk-covered wire. *Postage free.*

**THIS WILL SOLVE HALF YOUR TROUBLES.  
GUARANTEED** MINIMUM DISTORTION  
MAXIMUM AMPLIFICATION

Money refunded if not satisfied.

**STOCKED by all leading WIRELESS TRADERS**

Don't accept an imitation—See our name on Ebonite.

**SPECIALISTS IN PARTS FOR ALL CIRCUITS**

Advice free. New Catalogue free on application. Also trade list.

## WHOLESALE ONLY.

**WIRELESS DEALERS.** Our New 44-page Trade List of Radio parts now ready showing Trade and Retail prices. It is yours for the asking.

**COMPLETE SETS, ACCESSORIES & COMPONENT PARTS**

We were one of the very first Wholesale Factors of "Wireless," and our New Catalogue is the very latest thing in Wireless. Send Trade Card.

**STAGGERING PRICES. HUGE STOCKS.  
BUY FROM AN ESTABLISHED HOUSE  
IMPORTANT—Trade Only Supplied.**

**HOBDAY BROS., LTD.**, (Dept. B.), 21, 23, 25, & 27, ST EASTERN ST., LONDON E.C.2.

'Phone—CLERKENWELL 2800 (6 lines)



R.P.

# Home - built Wireless Components

• —a new Book giving  
complete constructional  
details and drawings

EVERY time the wireless enthusiast wants to build *every* part of his Set. Not only does he save money, but he is able to appreciate better how each individual component works.

It is not uncommon to find that the man who is sufficiently painstaking to make his own components will get better results from a 1-Valve Receiver than many will get from 3-Valve Sets. This is merely because he has the patience to experiment and to be continually making adjustments for the improvement of his reception.

If you are contemplating making additions to your Receiving Set, why not get a copy of **Home-built Wireless Components** and start making some of the parts yourself? With the technical data given and the very clear diagrammatic sketches, you can't possibly go wrong.

Remember, every article described has been actually built up and subjected to thorough tests.

Published by  
RADIO PRESS, LTD.,  
Devereux Court,  
Strand, W.C. 2.

2/6

From all Booksellers or  
2/8 post free direct.

R.P.

Radio Press Series No. 16

R.P.

Phones: REGENT 609. EAST HAM 172. WIMBLEDON 2398.

# I.R.M. 3 VALVE SET

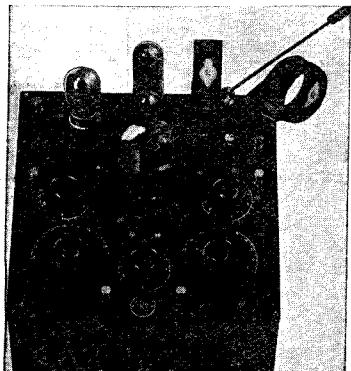

A highly efficient receiver with one stage of H.F. (tuned anode) amplification, and one stage note magnification.

This set will receive all British and Continental broadcasting. Loud-speaker results have actually been obtained at over 350 miles range.

Panel 10 inches square only. PRICE completely assembled with B.B.C. and Marconi Licences paid, **£9 9s.**

Best quality components for this set or any circuit supplied to constructors and experimenters at lowest possible prices. Technical advice free.

Crystal Sets from 12s. 6d.

**THE I.R.M. WAVE TRAP, IMPROVED TYPE.** With this trap attached to any set, a station half a mile away can be completely cut out. Price 25s., complete with plug-in Coil. When ordering please state wave-length to be eliminated.

SEND FOR ILLUSTRATED PAMPHLETS

The Wonderful "N.S." Accumulator may be charged in one hour. Will not sulphate under any circumstances. Can be charged and discharged at any rate without damage. May be left idle and uncharged for an indefinite period without deteriorating. Better and cheaper than any other accumulator on the market.

PRICES:—

4 volt, 30 A.H. actual, £1 2s. Carriage, 2s. 3d.

6 volt, 30 A.H. actual, £1 10s. Carriage, 2s. 9d.

WE SUPPLY EVERYTHING WIRELESS. SEND US YOUR INQUIRIES.

INTERNATIONAL RADIO MANUFACTURERS, Ltd.,

16, Palace House,

128, Shaftesbury Avenue, W.1 and at 39, Station Rd. Manor Park, E.12

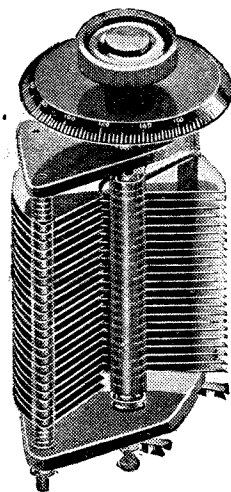

THE

J.B.

## PRECISION VARIABLE CONDENSERS

ALL BRITISH

Are those with a reputation for QUALITY and EFFICIENCY.

THE ACME OF PERFECTION.

One hole mounting, LARGE metal to metal bearings. END PLATES made by special process which ensures LOW DIELECTRIC LOSSES. This is a very important feature for SHARP TUNING.

Owing to the ACCURATE CLOSE SPACING, these Instruments take up much less room in Panel.

COMPLETELY ASSEMBLED WITH KNOB & DIAL

001	8/6	PACKING
00075	8/-	and
0005	7/-	POSTAGE
0003	5/9	Extra.
00025	5/9	One only 6d.
0002	5/-	Two 9d.
0001	4/9	Three 1/-
VERNIER	4/-	

**LOW MINIMUM CAPACITY**  
Example:—J.B. 100 mfd. Min. to Max. Ratio exceeds 17 to 1 by N.P. Lab. Test, which means wide Tuning range.

The J.B. TWIN Condenser for Double Tuned Anode Circuits, capacity each half 00025 mfd. .. 19/6 each. Ideal for use in the "Modern Wireless" Transatlantic Receiver.

Obtainable through your Dealer or direct from the Manufacturers:

**JACKSON BROS.** Condenser Experts,

FIRST FLOOR 8, POLAND ST., OXFORD ST., LONDON, W.1.

Works: 1 EW'SHAM, S.E. Phone: Lee Green 1235. Trade Inquiries invited.

# SELECTONE

## Super Radio L.F. TRANSFORMER



PERFECT Winding Insulation Shielding  
FREE FROM Distortion Burn Outs Stray Fields

GIVES PERFECT REPRODUCTION ON REFLEX CIRCUITS WITH MAXIMUM Efficiency & Power

N.B. Our new pattern embodies improved type pin terminals.

PRICE (5 to 1) 27/6 (2 to 1) 31/6

British Transformer & Electric Co. Brent Green, Hendon, N.W. "VIKINGS TENAX"

## Demand FORMO Products OBTAINABLE FROM ALL RELIABLE TRADERS

The Formo Crystal Detector Improved universal joint. Quick and permanent adjustment. 2 Crystal Cups. Instrument finish 2/6.

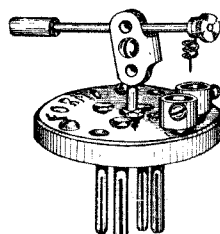

The Formo Rheostat

A SOUND MECHANICAL JOB, MACHINED THROUGHOUT.

15.5 ohms approx. Smooth and Silex Action. Base Turned from Solid Ebonit. Price 2/6

THE FORMO PLUG-IN DETECTOR REPLACES DETECTOR VALVE. A most useful fitting .. 4/-

DO NOT BUY SWISS OR GERMAN NUTS, TERMINALS, SCREWS, ETC. WE MAKE AND SUPPLY BETTER GOODS AT LOWER PRICES.

### THE FAMOUS FORMO TRANSFORMER

is, through sheer merit, the most widely used. It is not sold by frantic advertising. Owing to stringent test, breakdown under all ordinary working conditions is impossible.

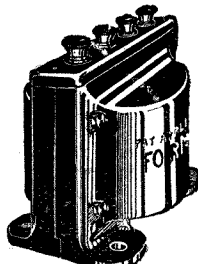

To meet all requirements it is now supplied in the following windings.

- A. Ratio ... 1-2
- B. Ratio ... 1-3
- C. Ratio ... 1-4
- D. Ratio ... 1-5

D. is supplied as standard winding.

We advise D. for 1st Stage, B. for 2nd Stage.

One Price, 18/-

Shrouded Type.

THE FORMO OPEN TYPE TRANSFORMER IS THE FINEST GENERAL PURPOSE INSTRUMENT OBTAINABLE AT 15/-. THE FORMO RHEOSTAT IS NOT EQUALLED AT 2/6. Make Use of the Formo Service.

The FORMO COMPANY,

Office and Works: 32, GRICKLEWOOD LANE, N.W. 2. Phone: Hamp. 1787.



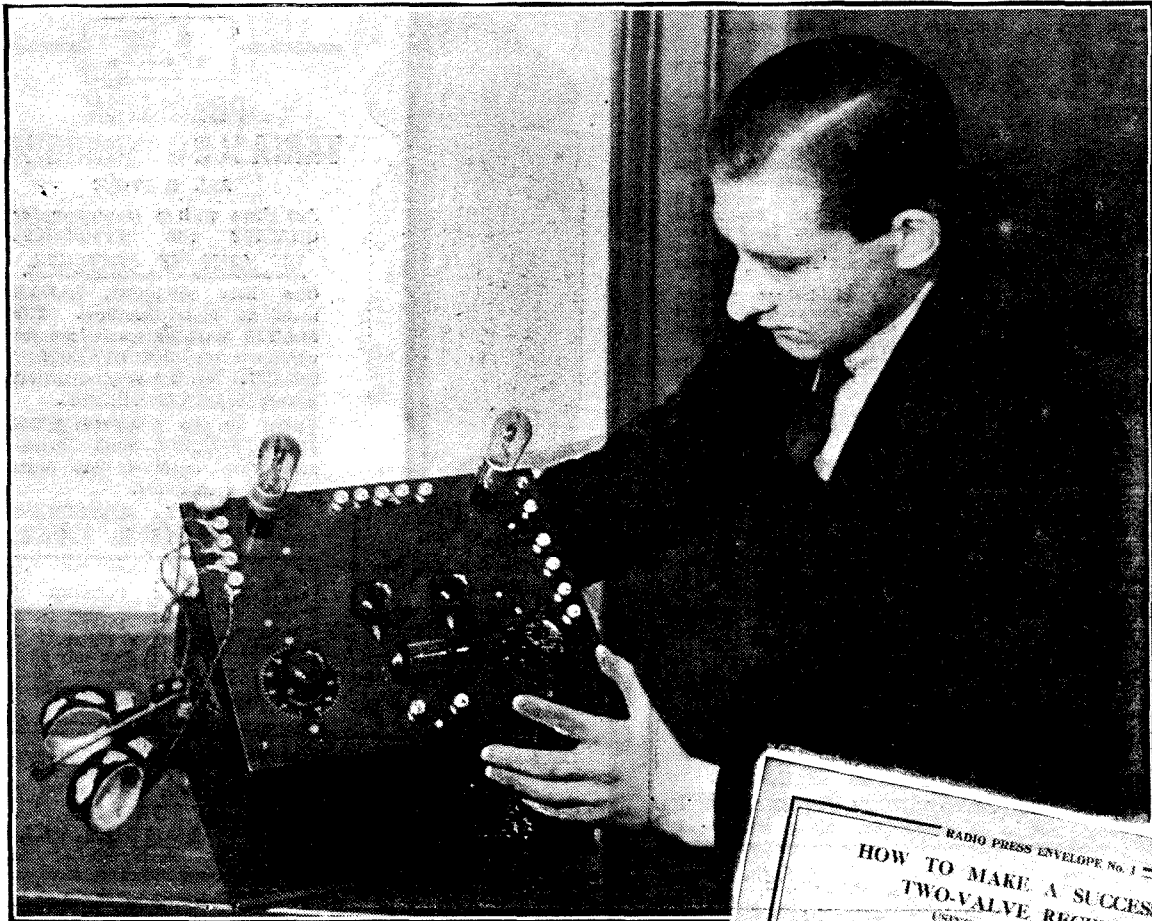

# Full instructions for building this fine S.T. 100 Set:

**T**HE tremendous success which followed the publication of constructional articles dealing with the S.T. 100 Circuit and the heavy demand from our readers for further articles on the same subject, has lead us to place on the market an Envelope containing the fullest details about it.

This Envelope can be bought by anyone in full confidence that with the least amount of mechanical ability he can build a really first-class Receiver—similar in every respect to the one illustrated above.

But even more important, this Envelope contains working hints and instructions which will prove invaluable to anyone operating a Reflex Set for the first time.

We have aimed, in fact, to make the material contained in this Envelope as comprehensive as possible. Why not get one to-day and start building this most fascinating of Receiving Sets?

From all Booksellers

# 1/6

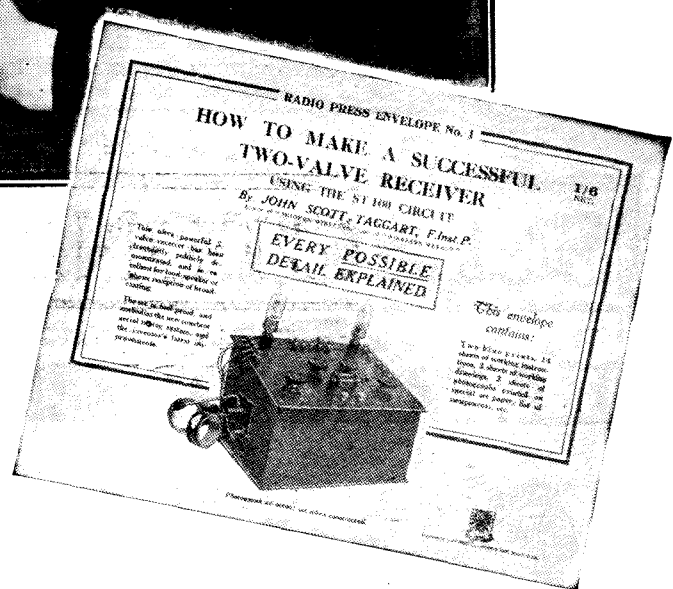

## SIMPLEX RADIO CHARTS.

WE have just published a further series of envelopes, each of which contains a full size chart for building a Valve Receiver (see below) together with a booklet which explains exactly the components which are required for the construction of the Set.

- No. 1.—A Two-Valve Receiver .. .. 1/-
- No. 2.—A Three-Valve Receiver .. .. 1/-
- No. 3.—A Four-Valve Receiver .. .. 1/-

From all booksellers or direct (postage 2d. extra.)

**RADIO PRESS Ltd.—Devereux Court, STRAND, W.C. 2.**

# ROWLEY & LOUIS,

12, The Broadway, Muswell Hill, N.10.

Phone 668 Hornsey.

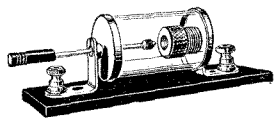

Crystal Detector, dust-proof, no wood, metal or screw required.

1/6 each.

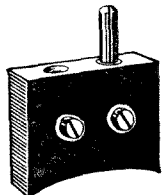

Ebonite Coil Plugs.  
9d each.

### VALVES.

Marconi R 11/9 each.  
Ediswan A-R (Bankrupt stock  
Cossa and of limited  
Mullard Ora quantity.)

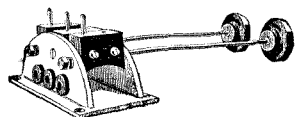

Ebonite and Aluminium Coil Holders.

2 way 5/6, 3 way 6/6.

Prices for other goods refer to last month's issue.

ALL GOODS SENT OFF SAME DAY.

PLEASE SEND SUFFICIENT POSTAGE.

# "DUANODE" CONDENSER

"As good as the best"

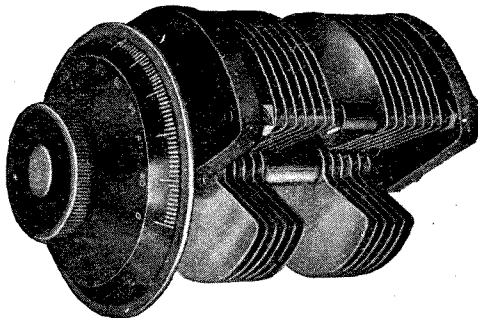

Realising the difficulty of tuning a circuit in which two stages of tuned anode H.F. Amplification is used, we have designed the "DUANODE" Condenser, as illustrated. This Condenser consists of TWO matched Condensers operated by one knob. Thus by using matched COILS it is possible to tune BOTH circuits perfectly with one operation only. The two sets of fixed Vanes are carefully

insulated one from the other, and the moving Vanes connected electrically; the spindle can thus be connected to H.T. Positive. This condenser can also be used for other purposes. The two halves (each of .0002 mfd.) can be used in series or parallel, giving capacities of .0001, .0002 and .0004.

Price 25/-

For "FALLON" COMPONENTS see our advertisements in "Wireless World," "Amateur Wireless" and "Popular Wireless" every week.

REPUTATION.—Your component is not a "FALLON" unless the name "FALLON" appears on same

Our motto is **QUALITY FIRST**, and every article carries our money back guarantee.

All **BRITISH** Manufacture. Prompt Delivery.

Cash with order. Please include postage on each article.

**FALLON** THE CONDENSER PEOPLE,  
230a, Hermitage Road, London, N. 4.

Phone: Tottenham 1932.

London Agents:—Vanstones, Ltd., 61, Chandos Street, London, W.C.2.

Sole Trade Distributors:—Messrs. G. W. I., Ltd., Shanklin Road, Crouch End, London, N.8, to whom all Trade Enquiries should be sent.

REVISED TRADE TERMS.

**FALLON CONDENSER MANUFACTURING CO., Ltd.**



Phone: MAYFAIR 1313

NEAR POLYTECHNIC

### GOODS OF QUALITY.

Products that are radiated from the heart of the shopping centre of London to the furthestmost corners of the world.

A few extracts from our catalogue:—

Accumulators. 6 volt. 40 amp. hours. British Made 29/6  
Coil Holders. 2 coil 6/-, 3 coil 9/-.  
Crystal Sets. 25/- each. Beautifully made.  
Headphones. Excellent quality, 14/6, 16/6, 19/-, and 25/-  
Variometer. Wound on ebonite, 200/700 metres 5/-.

## SCHEFF PUBLICITY ORGANISATION

125, PALL MALL, LONDON, S.W.1

are Advertisement Managers for

# MODERN WIRELESS AND WIRELESS WEEKLY

Particulars on application of RATES  
for both publications.

Phone: Regent 2440 (Two Lines).

An Ideal  
Gift

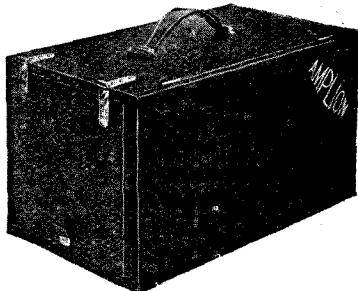

to your "WIRELESS" friend is the unique all-purpose Portable Amplion, suited to Radio reception both in and out of doors. The price of this model, which is obtainable from all Wireless Dealers of repute, is six guineas.

A postcard will bring full particulars.

THE PORTABLE

# AMPLION

LOUD SPEAKER

Alfred Graham & Company

(E. A. GRAHAM)

St. Andrew's Works, Clonton Park, London, S.E.4

Telephone: Sydenham 2820-1-2.

Telegrams: "Navalhada, Catgreen, London."

W24.

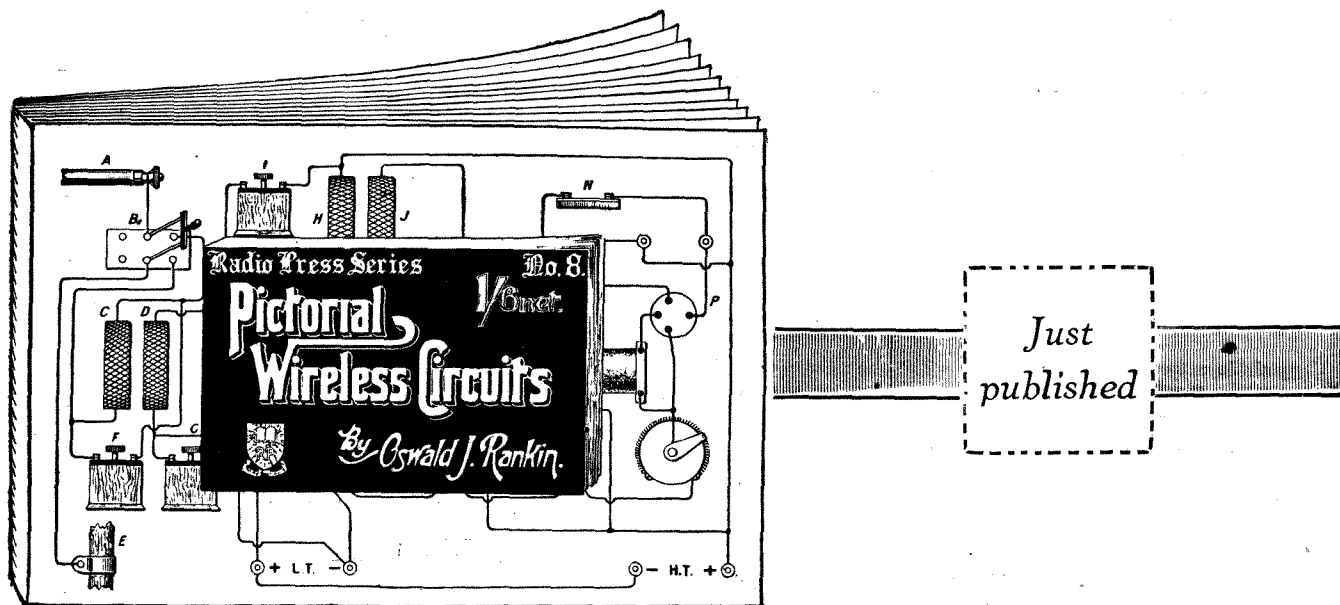

# Is reading a Circuit Diagram your Waterloo?

## Pictorial Wireless Circuits

- Simple Crystal Circuits.
- Variometer Crystal Circuits.
- L.F. Amplifying Circuits.
- Power Valve Amplifying Circuits.
- Single Valve Circuits
- Two and Three-Valve Circuits.
- Crystal-and-Valve Circuits.
- Flewelling Circuit.
- Four-Valve Circuits.
- Switching, etc., Circuits.

**1/6**

From all Booksellers  
or post free direct 1/8.

**W**HEN a Wireless enthusiast decides to build his own Set, his first job is to study the necessary wiring diagram. And that is where quite a number meet their Waterloo.

Those of us who can read circuit diagrams as easily as we can our morning paper, are apt to show but little sympathy for the extreme novice making his first flounders into Wireless.

Radio Press, however, appreciate that the correct reading of circuit diagrams is the first essential to the successful building of a Set, and are publishing an entirely new book which completely cuts out this difficulty.

Every circuit diagram in "Pictorial Wireless Circuits" is shown pictorially—that is to say, the actual components used are drawn instead of conventional signs for them. Thus there will be no excuse, for example, for any enthusiast not knowing the correct position for his filament rheostat.

Altogether over 70 circuits are shown, ranging from Simple Crystal Receivers to more elaborate Multivalve Sets.

If difficulty in reading circuit diagrams has hitherto prevented you from building or improving your Set—get a copy of this book to-day. It will be eightpence well spent.

**Radio Press Series No. 8.**

# Good Parts are the Chief Thing

Build your own set from sound parts and materials—you will then thoroughly understand your set and know that the quality of every detail is right. We test every part before we decide to stock it, and offer our customers unbiased advice and assistance.

## A Few Suggestions :

- Parts for Crystal Set - - - - - 7/6
- Parts for 1 Valve Set, without box panel or plug in coils - - - - - £1 12 6
- Parts for 3 Valve Set, including variometer, condensers, oak box, drilled ebonite panel, screws and terminals - - - - - £6 15 0

### 3 VALVE "ALL CONCERT" RECEIVERS

All parts and 3 coils for 3 valve "All Concert" receiver, excluding valves, batteries, phones, panel and box- - - £5 15 0

High Efficiency pure tone inter-valve transformers - - - - - 17/6

"W & M" high quality, accurate variable condensers, very low minimum capacity: .001 16/- .0005 12/-, .0003 10/6, .0002 7/6, vernier 4/6

"T.C.B." Resistances - - - - - 4/-  
 "T.C.B." Potentiometer - - - - - 5/-

HART & EXIDE ACCUMULATORS. All sizes supplied ready for use.

ALL DULL EMITTERS AND PEANUT VALVES IN STOCK.

Only tested high-quality parts are sold. No ex-Government or Continental stock.

Trade Supplied.  Enquiries Invited.

**GENERAL WIRELESS LTD**  
 21 GARRICK STREET  
 LONDON, W.C.2.

Nr. Leicester Sq.  
 Tube.

Telephone :  
 Gerrard 8460.

# ROSEBROS TESTED CRYSTALS.

These Crystals are now supplied in SEALED GLASS TUBES, which are packed in boxes containing one dozen. These boxes make an attractive window display.

### "ROSEBROS MARKONITE"

is a super-sensitive crystal for use on any set and with any wire contact. Every facet is sensitive and the clearness and volume of the tone obtained is MARVELLOUS. Retail price, 1/- per sealed tube containing one crystal.

### "ROSEBROS MARK IV."

This crystal is not superior in the general way to "ROSEBROS MARKONITE" (no crystal can claim that distinction), but for use on combined crystal and valve circuits it possesses certain merits which no other crystal has. It can be used with any wire contact or RIGID POINT. Retail price 1/- per sealed tube containing one crystal.

### HERTZITE—ZINCITE—TELLURIUM—BORNITE—&c.

are also supplied by us in glass Tubes, packed 12 in a box.

### WARNING.

Owing to the enormous demand for "ROSEBROS MARKONITE" and ROSEBROS "MARK IV." unscrupulous dealers are tempted to substitute inferior crystals under these names. The public therefore should see that every tube is sealed with a label bearing one of our TRADE MARKS, such as :

- "ROSEBROS MARKONITE,"
- "ROSEBROS MARK IV.,"
- "ROSEBROS HERTZITE."

and these ensure delivery of the genuine article.

ROSEBROS Tested Crystals are stocked by most Wireless Dealers, but should any difficulty arise in obtaining same, a sample tube will be sent post free on receipt of stamps or P.O. for 1s.

*Special Terms to the Trade, who are requested to write for Wireless List.*

**ROSE BROS.** **ELECTRICAL CO., LTD.,**  
 LONDON.—25-27, Milton Street, E.C.2.  
 GLASGOW.—194a, St. Vincent Street.  
 MANCHESTER.—25-27, Miller Street.  
 BRISTOL.—83a, Redcliff Street.

**B.B.C.**

**WIRELESS DRY BATTERIES**

For **B.B.C.** Sets

### No. 1 W.

Standard Pocket Lamp Size—4½ volt with patent spiral wire terminals and plug sockets to take Wander Plugs.

Note:—1 doz.=51 volts.

Used units replaced easily.

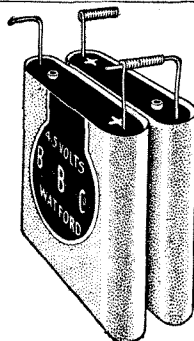

To connect in Series insert straight Terminal in Spiral of next battery. Bend spiral and thus ensure permanent electrical connection without soldering.

BRITISH MADE.

Patent applied for

Connect as illustrated.

**PRICE CARRIAGE PAID, 7/- PER DOZEN, WITH PLUG.**

### Standard Sizes :

- No. 2 W. Slab, 16½ volts, 3-volt tappings. Size approx. 9 x 1 x 3 ins. ... Price 3/- each
- No. 4 W. Slab, 36 volts, 3-volt tappings. Size approx. 10 x 1½ x 3 ins. ... " 6/6 "
- No. 5 W. Block, 60 volts, 3-volt tappings. Size approx. 9½ x 3½ x 3½ ins. ... " 12/- "

Prices include Wander Plug. Carriage Paid.

Manufactured by

Telephone: Watford 617.

**The BRITISH BATTERY CO. LTD.**  
 CLARENDON RD., WATFORD, HERTS.



# Why not build a Set like this yourself?

—the fullest details for it are given in

## Twelve Tested Wireless Sets

By Percy W. Harris

Assistant Editor of  
"Modern Wireless."

PRICE

2/6

By post

2/8

Shows you how to build all these Receiving Sets :

1. A 2/6 Crystal Set.
2. A Crystal Set on a New Principle.
3. A single Valve Magnifier.
4. A 2-Valve Magnifier.
5. A simple 2-Valve Receiver.
6. A 2-Valve Cabinet Set.
7. An "Old Folks" Receiver.
8. A 3-Valve "All Concert" Receiver.
9. A "Transatlantic" Receiver.
10. A 3-Valve Reinartz Set.
11. An S.T. 100 Set for the beginner.
12. Wave traps in various forms

**P**ROBABLY no writer of Books and Articles dealing with the constructional side of Wireless is more popular than Percy W. Harris.

The reasons for this may be two-fold. Firstly, that he takes extraordinary pains to make every detail clear and intelligible to even the veriest novice ; and, secondly that the Instruments he describes, although refreshingly original in design, give extraordinarily good results.

No purchaser of this Book need be afraid that he does not possess sufficient skill to build a Wireless Receiving Set or that elaborate tools are necessary. If he has sufficient patience to follow clear diagrams and explanations, and if he can use a small saw, a file and a drill, then success is assured.



Radio  
Press  
Series  
No.  
14.

# The GRAMAPHIX LOUD SPEAKER

This is a most efficient device, to which the ordinary headphones are clipped and the Gramaphix mounted on the tone-arm of a gramophone.

**Straight or Curved Horns supplied to fit Gramaphix**

Straight ... ..	6/6	Wireless List 'I' sent post free.
Curved ... ..	12/6	
Gramaphix... ..	10/6	

[Postage 8d. extra.]

**RICHARD MELHUISH, Ltd.,**

Electrical Engineers and Wireless Experts,

50, 51 & 84, FETTER LANE, LONDON, E.C.4. Estd. 1828.

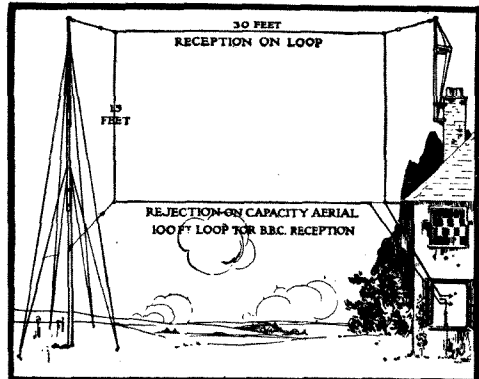
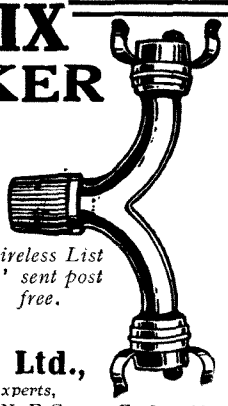

How to fix an efficient 100ft. Aerial in a 30ft. garden. 100ft. Aerial with Insulators, Slings, etc., 7/3.  
**SIMPSON & BLYTHE, 8-9, Sherwood Street, Piccadilly, W.1.** Phone—2650 Gerrard

**'TURRET' Columbian Pine Masts,**  
 by Naval Experts.  
**REDUCED PRICES.**  
 27 ft. Turret Two 37 6  
 28 ft. Turret 'super' 53 8  
 36 ft. in 3 sections 71 6  
 42 ft. Telescopic 79 6  
 56 ft. Telescopic Top, complete 86 4 9  
 Turret Poles, 13 ft. 5 9  
 16 ft. 2 1/2 in. base 7 9  
 28 ft. with 2 pairs clamps 17 9  
 42 ft. with 4 pairs steel clamps 23 9

# Claristal

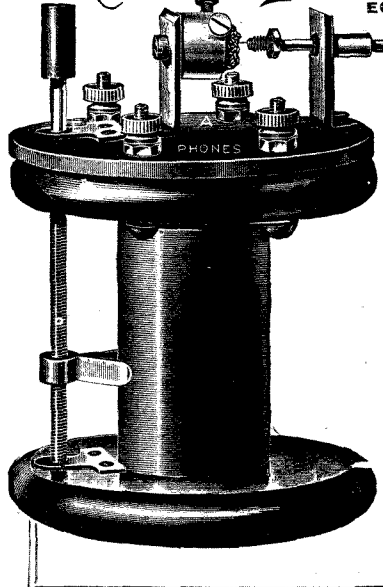

EGD.  
 Fully Illustrated Radio Catalogue, M/103, on request. Enclose Business Card or Memo for special Trade Terms and Discounts.

**WIRELESS CONSTRUCTIONAL RECEIVING SET. BRITISH MADE. PHENOMENAL RESULTS!**

Will receive Signals and Broadcasting Entertainments as loudly and clearly as most expensive Crystal Sets. Can easily be constructed in a few minutes. **No tools or technical knowledge required.**

Complete Sets of Parts, including "SONYTE" Crystal, packed in attractive box with illustrated diagram of instructions. 5 6.

We also supply the Set ready constructed. Price, including B.B.C. Fee, 7 6. Post 6d.

**The "Claristal" Aerial Set,** comprising 100 ft. Aerial Wire, 6 Insulators, Leading-in Tube, and 3 yards Insulated Wire. 3 6.

These lines are stocked by all first-class Radio dealers. Write direct if unable to obtain.

## HIGH FREQUENCY TRANSFORMERS.

Wavelength 350-3,200 metres. Suitable for panel mounting. No. N54/100. 22 6. Plug-in type to fit Standard Valve Socket. Fitted with 4-point Double Pole Switch, as illustrated. No. N54 500. 27 6 each. Mounted on Ebonite Base with Terminals marked for respective connections and fitted with 4-point Double Pole Switch. No. N54/200. 30/- each.

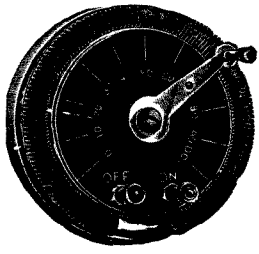
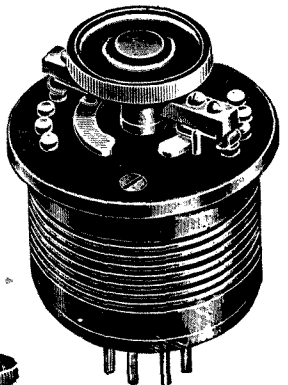

**REGULATING RESISTANCE**  
 fitted with Engraved Dial, as illustrated.  
 2/8

**COIL HOLDERS.**  
 Well designed, perfectly finished. Mounted on Ebonite Panel.  
 2-Coil Type 7/6.  
 3-Coil Type, as illustrated 10/6.

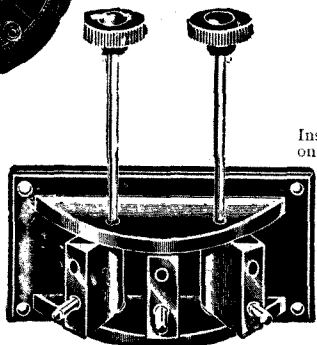

**SILK, COTTON AND ENAMELLED**  
 Instrument Wires supplied on small or large reels. Competitive Prices. Prompt deliveries. Send your enquiries.

**AERIAL 3-EARTH SWITCH.**  
 Mounted on White Porcelain Base.  
 Single Pole 1-way, 1/6  
 Single Pole 2-way, 2/-



**AERIAL WIRES.**  
 Chain Braid  
 Aerial Wire gives maximum Efficiency. 2/8 per 100 ft.  
 See Catalogue for full range.

**TERMINALS AND STAMPINGS**  
 At keen prices. See Catalogue for full particulars and prices.



**Ward & Goldstone's**  
 PENDLETON MANCHESTER LTD.  
 Address all communications to Headquarters & Works:  
 PENDLETON, MANCHESTER.  
 GLASGOW DEPOT: 65, BOTHWELL STREET.

## AMATEUR CONSTRUCTORS!

We Supply Everything. ALL BRITISH.

Tapp of Inductance—a clear advance of any other tuning, providing the a plugs are correctly arranged. Our tuning inductances are wound on spectra by 18 gauge 28 S.W.G. tubes with 26 s.w.g. double cotton covered copper wire in the following ratio: 10 sections of 10 turns each, and 10 sections of 1 turn each. This winding will tune from 200 to 1,000 metres. Price 3/6.

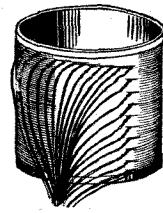

Ebonite panel for the tapped inductances, 7 in. by 5 in. by 3/16 in. drilled for 2 sets of 5 in. each contact studs and terminals, complete with 22 studs, 2 switch arms, 2 phone, earth and aerial terminals, assembled as shown and blue prim of connections. Price 7/6.

Polished Mahogany sloping front cabinet set above panel, Price 6/- The Coil and Panel make a most efficient tuner for Crystal or Valve.

**Put out your Local Station with our new REJECTOR.**  
 The REJECTOR is fitted into a polished mahogany cabinet. We guarantee you can cut out your local station and receiver, providing a set has the necessary range. Price 19/6.

**P. H. BOYS & CO.,** Electrical and Wireless Engineers,  
 187, GOSWELL RD., LONDON, E.C.1  
 Phone: Clerkenwell 4454.

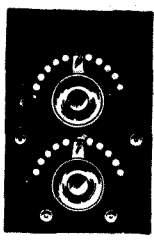

## TWO "EL-BE" UTILITIES. "EL-BE" ANTI CAPACITY HANDLES.

No Screws. No Clamps.



Fixed by Suction—Removed in a second.  
 A Type for Horizontal working. Price 2/2 each.  
 C Type for Vertical working. Post free.  
 A perfect combination with the "EL-BE" Coil Holder.

## "EL-BE" COIL HOLDERS

USE SINGLE COIL HOLDERS FOR AXIAL MOUNTING. EFFICIENT. HIGHLY RECOMMENDED.  
 Ebonite Basket Coil Mounts to plug in above, 2 each.  
 Short Circuiting Plug for Coilholder 1/3 each.  
 Ask your Dealer for them.

**LEIGH BROS.** Tel.: Museum 4192.  
 37 Sidmouth Street & 1a Prospect Terrace,  
 Gray's Inn Road, LONDON, W.C.1.

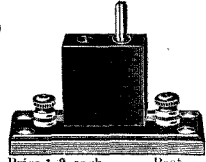

Price 1/9 each. Post Free.  
 5/- set of three.



# “FIRST CLASS” THROUGHOUT

NEITHER money nor brains have been spared in bringing WIRELESS WEEKLY to its position as the premier authentic weekly Wireless Journal in this Country.

To the Experimenter it is indispensable, to the enthusiast who has made some progress in the

science of Radio it is invaluable, while the absolute beginner will appreciate its sincere spirit of help and good-fellowship.

If you are not a regular reader you are missing exceptional opportunities for becoming better acquainted with to-day's great Wireless problems.

# Wireless



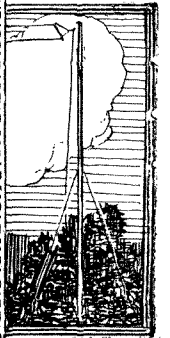
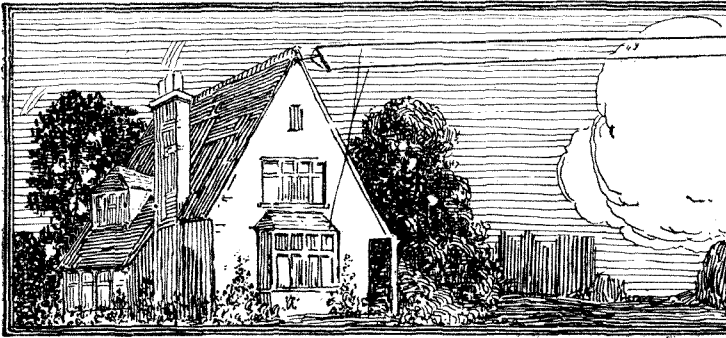

# Xmas Gifts to all Readers

COMMENCING with the issue dated December 12th, WIRELESS WEEKLY will contain a series of special articles on important subjects. One of these series will deal with Dual Amplification—a phase of Wireless which is new to a very large number of experimenters, and which has never been thoroughly discussed.

These articles will be written by John Scott-Taggart, F.Inst.P. (Editor) who is a recognised authority on the Valve. They will contain original data and a considerable amount of facts relating to reflex circuits which is entirely new.

Other special features will combine to make these six issues remarkable value for money.

## Details of the Half-Price Book Scheme

AS a special inducement to new readers, we have formulated a Scheme whereby they can obtain any one Book from the Radio Press Series of Books at exactly half price.

In every one of these six issues will appear a dated coupon. These six coupons must be saved and sent up to Radio Press, Ltd., together with a Postal Order for any one Radio Press Book at half price. Only one Book can be supplied to any reader, but any Book can be selected so that the coupons can, if you wish, be worth as much as 5s. to you.

This expensive offer is made solely to introduce WIRELESS WEEKLY to new readers. We are confident that, having read these few issues, they will appreciate its sterling value for money, and will wish to continue reading it.

A coupon will also appear in the 7th issue, so that if you cannot buy the Dec. 12th number you can start with Dec. 19th issue.

*SPECIAL NOTE:—It is advisable to give your order at once to your Newsagent, as owing to the immense demand, there may be an insufficient supply of the first Special Issue. Remember the date—December 12th.*

Published by  
**RADIO PRESS LTD.,**  
Dev. reux Court, Strand, W.C.2

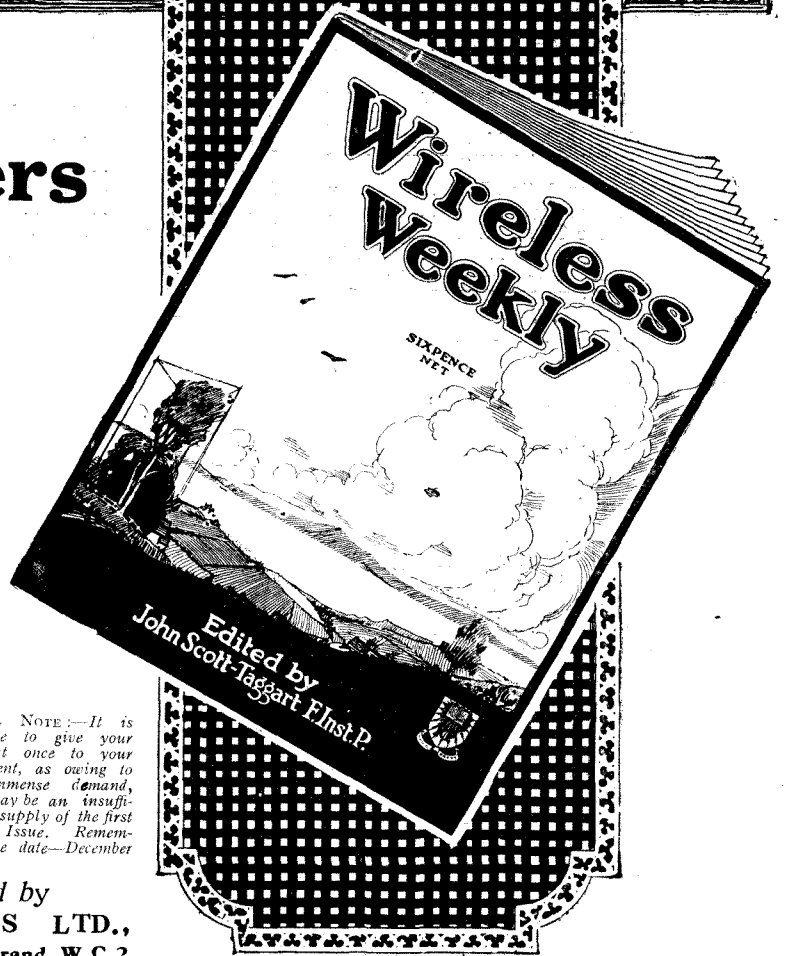

# 6 d. weekly

# Weekly

# Index to Advertisers

	PAGE
A.P.A.I.L. .. Junior Wireless	60
Autoveyors Ltd. .. ..	xxvii
Ball (T. C.) .. Junior Wireless	60
Bowyer-Lowe Co. .. ..	xxix
Boys (P. H.) & Co., Ltd. ..	xliii
British Battery Co., Ltd. (The)	xli
British Thomson-Houston Co., Ltd.	xix
British Transformer & Electric Co.	xxxvii
Brown Bros. .. ..	v
Burne-Jones, Ltd. .. ..	xxxiii
Buss (T. O.) .. ..	xviii
Chloride Elec. Storage Co. ..	xxiii
Clarke (H.) & Co. (Manchester), Ltd.	vi
Cline Radio Co. .. ..	xxxix
Cossor Valve Co. Junior Wireless	35
Dixon (Leslie) & Co. .. ..	xxvii
Dubilier Condenser Co. (1921), Ltd.	xii
(Facing matter) .. ..	xii
Elkay Wireless Co. .. ..	xxv
Ever-Ready Co. (Gt. Brit.), Ltd.	xxix
Falk, Stadelmann & Co., Ltd. ..	v
Fallon Condenser Co. .. ..	xxxix
Fellows Magneto Co., Ltd. (Facing matter)	xiii

	PAGE
Formo Co. .. ..	xxxvii
Fuller's United Elec. Works, Ltd.	xxix
Gambrell Bros., Ltd. .. ..	xx
General Electric Co., Ltd. (Facing matter)	ix
General Wireless Ltd. .. ..	xli
George Mfg. Co. .. ..	iii
Graham (Alfred) & Co. .. ..	xxxix
Graham (R. F.) & Co. .. ..	xxii
Griffin's .. ..	xxxv
Heywood (N.) .. ..	xlvi
Hobday Bros. .. ..	xxxv
Igranic Electric Co., Ltd. ..	xv
International Radio Mfrs., Ltd.	xxxvii
Jackson Bros. .. ..	xxxvii
Joanes, W. .. ..	xxxiii
Leigh Bros. .. ..	xliii
McMichael (L.) Ltd. Junior Wireless	59
Marconi Scientific Instrument Co., Ltd.	xxxiii
Marconi Wireless Telegraph Co., Ltd.	xxxix
Melhuish, Richard, Ltd. .. ..	xliii
Metropolitan-Vickers Elec. Co., Ltd.	iv

	PAGE
M. L. Magneto Syndicate .. ..	xx
Mullard Radio Valve Co. Ltd. (Facing matter)	xi
New London Electron Works ..	xxxix
Omniphone Wireless Co. .. Junior Wireless	60
Radio Communication Co., Ltd.	xvi, xvii
Radio Instruments, Ltd. Cover	iv
Radio Stocks, Ltd. .. ..	xxvii
Raymond (K.) .. ..	vii
Robinson, Lionel, & Co. .. ..	xxxv
Rose Bros. Electrical Co. .. ..	xli
Rowley & Louis .. ..	xxxix
Saxon Radio Co. .. ..	xxvii
Service Co., Ltd. .. ..	v
Silvertown Co. .. ..	xxi
Simpson & Blythe .. ..	xliii
Swan (C. S.) .. Junior Wireless	60
Tingey Wireless, Ltd. (Facing matter)	xliii
Universal Electric Supply Co., Ltd.	xxxix
Ward & Goldstone, Ltd. .. ..	xliii
Western Electric Co., Ltd. Cover	ii
Willesford .. Junior Wireless	60

## Heywoods Head Phone Pads give you comfort while listening in

Prevent Earache. Improve Reception.

per 1/9 pair

If your dealer cannot supply, send 1/9, giving your dealer's name to

**N. HEYWOOD** 386, Richmond Rd., Twickenham, Middlsex  
Trade Enquiries Invited.

EDINBURGH.  
Spensers (Scotland), Ltd., 119, George St., Edinburgh. Agents for Burndept, Ltd.

J. DYSON,  
5 & 7, Godwin Street, Bradford. Complete Sets. All Accessories. Tele. 6037 & 6038. Telegrams: "Equipment."

A. Franks, Ltd., 95-97, Deansgate, 44, Market Street, 73, Oxford Street, 12, Victoria Street, Manchester, and 90, Bradshawgate, Bolton.

**Rd. STONE & SONS, LTD.,**  
Wellington, Salop.  
Manufacturers of—  
**BOXES & CABINETS**  
in all timbers.

**WIRELESS INVENTORS.**  
Advice Handbook on Patents and Trade Marks. Consultations free.—B. T. King, Regd. Patent Agent, 146a, Queen Victoria St., E. C. 4. Phone: Central 682. 36 yrs. refs.

EDINBURGH.  
Wm. Sinclair, 60-64, Thistle St., Edinburgh. All component parts in stock at lowest prices.

**WALKERS' WIRELESS**  
Hold the largest variety of wireless apparatus in the North. Send for particulars. 31, Westgate Road, Newcastle-on-Tyne.

**"EIFFEL TOWER" MASTS.**  
(Trade Mark) Reg. Des. 694837.  
WILKINSON, Lonsdale Road, Kilburn, N.W.6.  
Write for Lists.

# COUPON

## Questions and Answers

In future this coupon must be accompanied with 2/6 P.O.

"MODERN WIRELESS" December, 1923,

# USE THIS COUPON

in writing to advertisers in "Modern Wireless."

CUT HERE

In connection with your announcement in MODERN WIRELESS, please supply me with:

Enclosed please find remittance of.....  
(Leave blank if not an order)

If an open envelope is used in applying for catalogues a half-penny stamp will cover postage.

Name.....

Address.....

Date.....

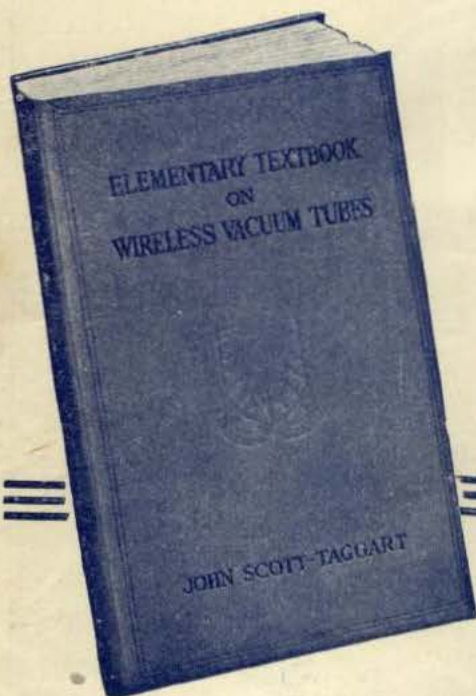

## —a necessity for every Experimenter

### Contents

1. Fleming Valves.
2. The 3-Electrode Vacuum Tube.
3. Cascade Vacuum Tube Amplifiers.
4. Regenerative Amplification and Self-oscillation.
5. Regenerative Reception of Signals.
6. C.W. Receiving Circuits.
7. Vacuum Tube Transmitters.
8. Radio-Telephony employing Vacuum Tubes.
9. Further Vacuum Tube Amplifications.

**10/-**

post free

**T**HIS Book should be in the hand of every Experimenter who wants to obtain a thorough understanding of Wireless.

It is recognised as the only standard Text Book sold at a price within the reach of anyone. Beautifully bound in solid cloth and plentifully illustrated with circuit diagrams and charts it is a vital necessity to the student, the research worker and the designer. If you are building a Set for pleasure or for profit, get a copy of this Book and understand the fundamental principles of Radio.

Obtainable from all Booksellers or direct from Publishers:—

**RADIO PRESS, LTD.,**  
**Devereux Court, Strand, W.C.2**





# The **RI** Xmas Catalogue

**Y**OUR friends who are interested in Wireless will appreciate an R.I. component as an Xmas greeting.

A catalogue, overflowing with illustrations and accurate descriptions of all our apparatus will be sent to you free on application. It provides a new field in seasonable gifts, always appreciated and always unique.

These illustrations show a few R.I. products designed on 25 years' experience, and built throughout in our factory by the best British Labour.

R.I. components and sets are the accepted British Standards of today. No other components equal them in efficiency or finish.

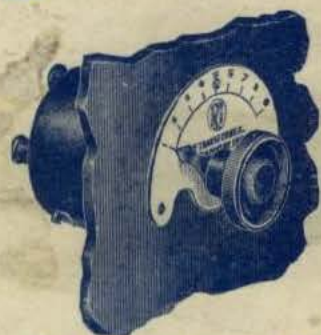

Combined Variable Intervalve Reaction and Anode Reactance. Wave-length range, 200-4,000 metres. **45/-**

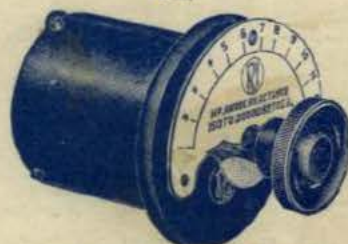

Improved Adjustable H.F. Anode Reactance. Wave length range 150-20,000 metres. **35/-**

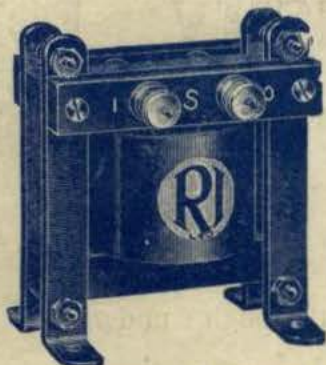

The famous R.I.L.F. intervalve transformer. One price, one quality.

**25/-**



H.F. Transformer with 9 point switch 150-4,000 metres, designed for easy panel mounting, scale may be used as template.

**35/-**

S.T. 100—complete set of parts ready for mounting as illustrated.

**£8 18 8**



## RADIO INSTRUMENTS LTD.,

Managing Director: **J. JOSEPH, M.I.E.E.**

Chief Designer: **W. A. APPLETON, M.B.E., M.I.R.E.,** late Admiralty Technical Research Officer.

Works, Offices and Showrooms:

**12, HYDE STREET, NEW OXFORD STREET, W.C.1.**

Telephones: Regent 6214-6215-6216.

Telegrams: "Instradio, London."

NORTHERN DEPOTS: 19, Hopwood Avenue, MANCHESTER, and Trinity House, Commercial Street, LEEDS.